



AUTHORIZED  
PRODUCT MANUAL

**DX7**

DIGITAL PROGRAMMABLE

ALGORITHM SYNTHESIZER



**YAMAHA**  
**Digital Programmable**  
**Algorithm Synthesizer**

**OPERATION MANUAL**

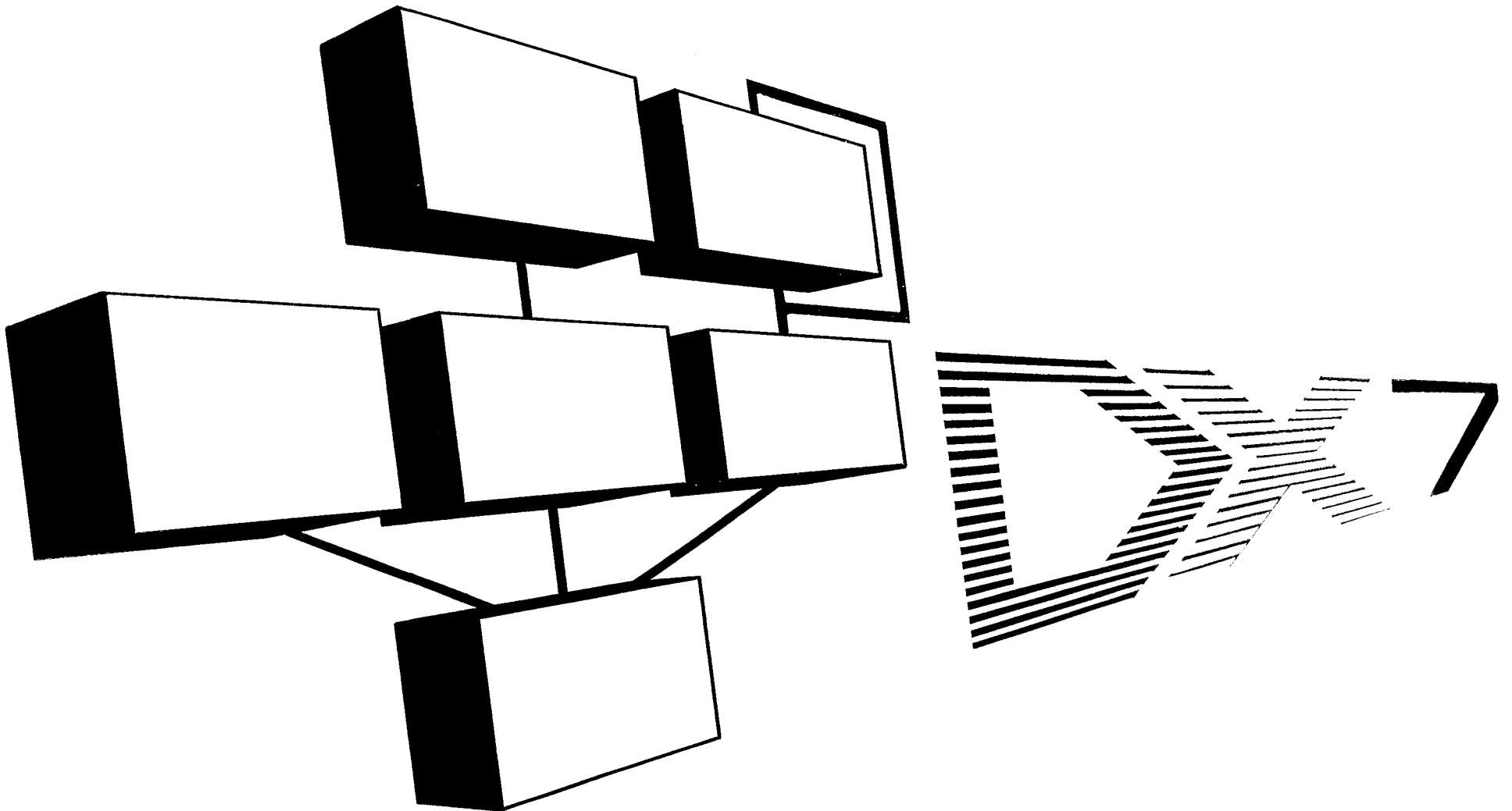

# PRECAUTIONS

## Location

Avoid placing the DX7 in direct sunlight or close to a source of heat. Also, avoid locations in which the instrument is likely to be subjected to vibration, excessive dust, cold, or moisture. Extreme temperatures can ruin the LCD display.

## Handling

Avoid applying excessive force to the slide knobs, dropping or rough handling. While the internal circuitry is of reliable, solid state design, the DX7 is nonetheless a fine instrument that should be treated with care.

## Power Cord

Always grip the plug directly when removing it from an AC receptacle. Removing the plug from the AC receptacle by pulling the cord can result in damage to the cord, and possibly a short circuit. It is also a good idea to disconnect the DX7 from the AC receptacle if you don't plan to use the instrument for an extended period of time.

## Relocation

If you plan to move the DX7 once it has been set up, first be sure to disconnect all cables that connect it to other equipment. This will help prevent accidental damage to the instrument or shorting of the cables.

## Connections

Carefully follow the "Setup" instructions in this manual when you set up the DX7. Improper connection of cables can lead to serious damage of the instrument, amplifier, and/or speakers.

## Cartridge Care

The RAM (user programmable) and ROM (factory preset) cartridges have no moving parts, other than their memory protect or bank selector switches, nor do they have batteries. They should, however, be kept clean and dry to protect their connectors. They should also be kept away from strong electrostatic fields, as produced by sparking electric motors and solenoids, fluorescent lights, and so forth; as with all electronic memories, the data (voices) could be accidentally altered. As a further precaution against voice loss in the event of a synthesizer malfunction, it is a good idea to remove the RAM cartridge from its slot in the DX7 before you turn power on or off.

## Cleaning

Use only a mild detergent on a cloth, and dry with a soft cloth. Never use solvents (such as benzine or thinner) since they can melt or discolor the instrument.

## Electrical Storms (Lightning)

Computer circuitry including that in the DX7, is sensitive to voltage spikes. For this reason, the DX7 should be turned off and unplugged from the AC receptacle in the event of an electrical storm. This precaution will avoid the chance that a high voltage spike caused by lightning will damage the instrument.

## Electromagnetic Fields

Computer circuitry is also sensitive to electromagnetic radiation. Television sets, as well as radio receivers, transmitters and transceivers, and wireless microphone or intercom systems are all potential sources of such radiation, and should be kept at least several feet from the DX7 to avoid possible interference or random "errors."

## If The Sound is Too Quiet

Check the FOOT CONTROL. There are two foot controller jacks, VOLUME and MODULATION. Two additional jacks are for foot switches, SUSTAIN and PORTAMENTO. If the foot controller is plugged into the SUSTAIN or PORTAMENTO jack, it will not work. Also, when the controller is plugged into the VOLUME jack and is tilted forward, there will be little or no sound regardless of how you set the VOLUME control on the front panel.

Some voices are inherently quieter than others. Often this is due to the amount of touch sensitivity which may be programmed into a voice. If the voice is programmed so that the note will become louder if you press the key harder, or if you press it faster, then a less vigorous playing style will result in a quieter note. Played the same way another voice which is less touch sensitive will sound louder. The voice which is initially louder, however, may not become much louder (if at all) as you play the notes harder. These qualities are user-programmable, even for the preset voices, as explained elsewhere in this manual.

## Save This Manual

The information in this manual is likely to be useful for future reference. Even if you feel reasonably familiar with the instrument, save this manual; reviewing it a few months from now, after you have had considerable experience with the DX7, may prove to be very informative.

## INTRODUCTION

The DX7 is the world's first fully user programmable and preset FM digital synthesizer. If you're used to conventional synthesizers, one look at the DX7 will tell you that something unique has happened. There are no knobs: just two linear controls, one of which is for volume, an LED digital display a small alphanumeric liquid crystal display (LCD), and a number of flat panel membrane switches. There are no voltage controlled oscillators, amplifiers or filters (VCOs, VCAs, or VCFs), nor are there any conventional envelope generators (EGs). Instead, the DX7 utilizes a totally unique method to create the richest, most naturally expressive sound available in any electronic keyboard. This special sound generation technology is called FM Digital Synthesis. FM Digital Synthesis enables the DX7 to create the overtones that would be present in an actual acoustic instrument, and to vary them over time in a precise, controllable manner to produce uncanny realism when you're playing an acoustic voice — or to produce incredible fantasy sounds — the possibilities are without limit.

Because the DX7 creates sounds differently than conventional analog or purely digital synthesizers, you'll have to spend some time re-educating yourself with the aid of this manual. After you've become familiar with the panel, a few new terms, and the general concept of FM digital synthesis, you'll love the precision and tremendous versatility at your disposal. If you're already an experienced synthesist, you will soon be able to go right for a particular sound. Whether you're a beginner or a world class performer, you can enjoy the large library of preset sounds that come with the DX7.

The DX7 is delivered ready to play, loaded with 32 beautifully voiced, useful, factory preset sounds. These sounds can be instantly changed, or can be replaced by additional factory-supplied sounds from a library of 128 that are supplied on special solid state cartridges. Literally hundreds of exciting sounds can be at your fingertips with just the press a few selector buttons. You don't have to program a single thing... unless you want to. Presets won't handle every job, and there's nothing that says you have to use ours. You can make your own voices.

The compact size and relatively few controls of the DX7 can be deceiving. Almost every button and knob have multiple functions (depending on the selected operating mode) so that a total of some 168 parameters can be altered. In fact, the DX7 has more programmability than any synthesizers Yamaha has ever before

offered to the public, providing greater control over the sound than large or modular systems.

The DX7 keyboard is fully polyphonic with 16-note simultaneous capability, so the sustain of previous notes will not be cut short when you're playing with all 10 fingers. It is also highly responsive to player expression. The harder or faster a key is played, the louder the initial attack of the note — just like a piano. Unlike a piano, however, the degree of touch response is programmable... both in sensitivity to the speed (velocity) at which the key is pressed, and in sensitivity to how hard you press after the kit hits the stop (after touch).

You can program voices from scratch (using a voice initialize function). If you like an existing voice, you can edit it to make subtle changes, or transform its character completely.

Because the DX7 employs unique FM tone generation techniques and lets you program them with the precision and repeatability of digital control, you'll be able to create voices that are a giant step beyond the capability of former synthesizers. Pure sounds. Richly textured sounds. Outer space sounds. Bold, heavy sounds. Subtle, delicate sounds. Uncannily accurate acoustic sounds. All are possible with the high fidelity that FM digital tone generation can provide.

Once you've edited a voice or created an entirely new one, you can store it in the internal memory and/or in special solid state cartridges. A battery prevents loss of memory — even after the instrument is unplugged from the AC receptacle.

### Up to 96 Voices Can Be "On Line" Ready for Instant Recall

Voices (sounds or "instruments") may be saved in 3 different ways with the DX7. As mentioned above, the synthesizer has 32 internal voice memories that can hold any combination of factory preset sounds or voices you create. In addition to the internal memories, one of two types of memory cartridges may be inserted in the instrument for additional "on line" memory. Pushbuttons enable you to select from the internal and cartridge voices.

A total of 128 factory preset voices are provided. Obviously they all cannot fit in the 32 internal memories at once; these voices are actually supplied to you stored in 2 solid state ROM (Read Only Memory) cartridges that each hold 64 voices, arranged in two banks of 32. You move a slide switch on the cartridge to gain access to

voices 1-32 in Bank A or 1-32 in Bank B — access for playing, editing, or loading into the synthesizer's internal memories. Before the DX7 is shipped, 32 of the 128 voices called the "Master Group" are loaded from the bank A of the #3 ROM cartridge into the synthesizer's internal memories. This means that a cartridge does not have to be installed in order for you to open the carton, plug in headphones or an amplifier/speaker system, turn on power, and begin playing.

You can edit the preset voices, or make voices from scratch, but you cannot permanently store your own voices on the ROM cartridges. For this purpose, a third storage method is provided: an EEPROM (Electrically Erasable Programmable Read Only Memory) cartridge which, for simplicity, we call a RAM cartridge (Random Access Memory). The RAM cartridges go in the same slot as the ROM cartridges, and superficially they look the same. However, because of the added complexity of RAM memory, only 32 voices will fit in one of these cartridges. The slide switch on the RAM cartridge is actually an additional "write protect" feature that prevents accidental erasure of voices you have stored; it is not a bank A-B selector.

This arrangement lets you have a total of 96 voices at your fingertips since you can have any 32 voices you wish loaded in the internal memories, then install one of the 64-voice ROM cartridges. You switch between internal and cartridge voices with the press of a button, and between cartridge banks A & B with a slide switch. Of course, if you allow for changing cartridges, which takes just a second, your live performance voice library is really unlimited.

*NOTE Portions of the front panel are used to illustrate the text throughout this manual; it should be relatively easy to see where these "spot" illustrations fit in the context of the entire instrument if you are reading the manual with the DX7 in front of you. If the instrument is not handy we suggest opening this cover fully revealing an overall front panel illustration that will remain visible as you flip through the inside pages. Originally ROM cartridges were numbered #1 & 2. Later models were shipped with ROM cartridges #3 & 4 instead. Both sets have similar voices.*

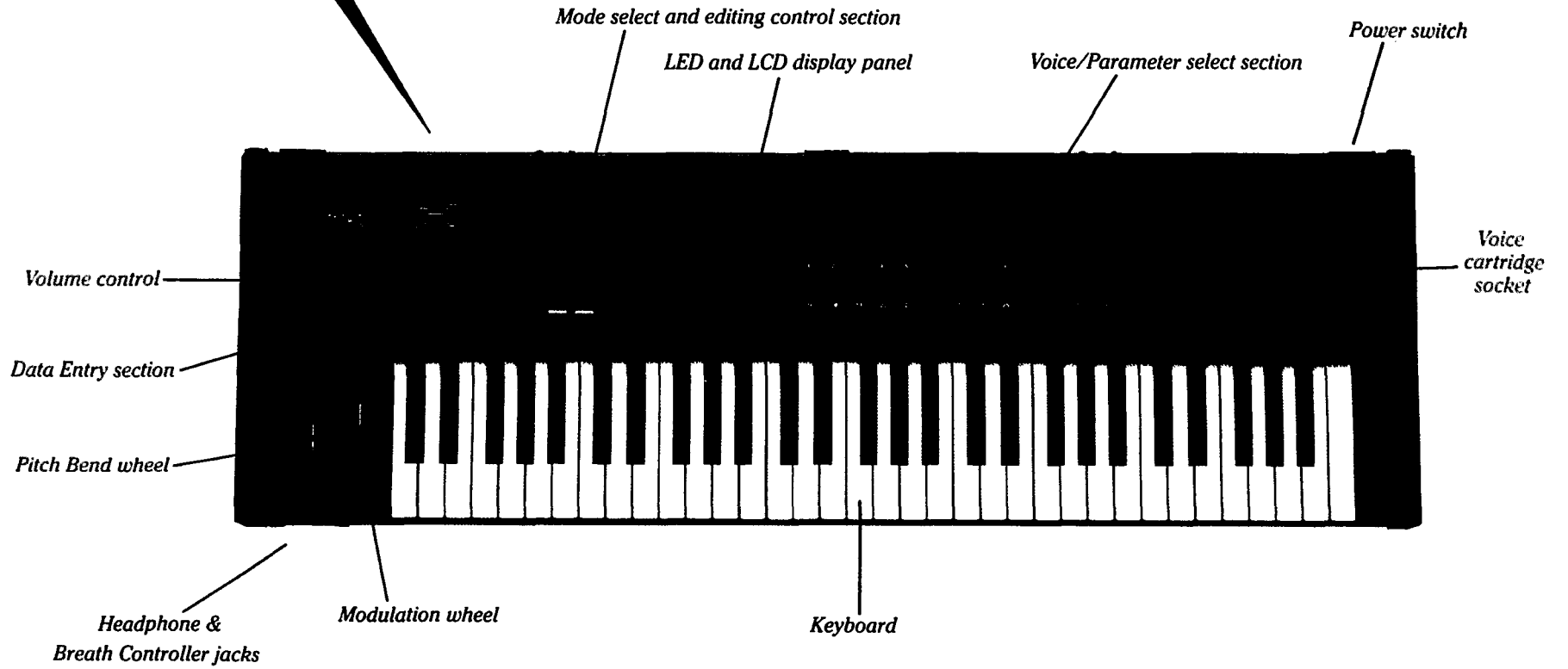
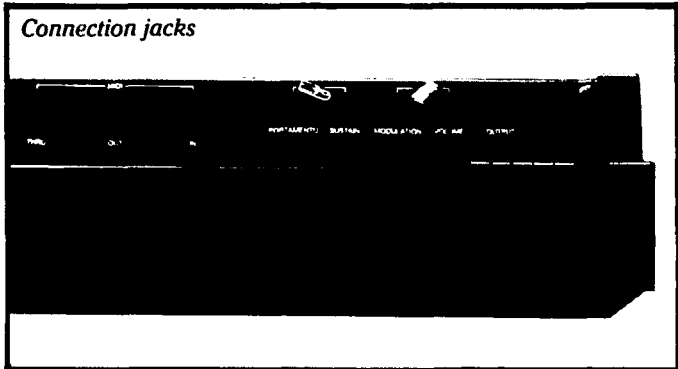

## **NOTE FOR SYNTHESIZERS SOLD BY THE U.S.A.**

2

Internally, the DX7 generates signals in the radio frequency spectrum. If the instrument is installed in the immediate proximity of some types of audio or video devices (within ten feet), interference may occur.

Federal Communications Commission (FCC) Rule Part 15, Subpart J, establishes design and manufacturing standards that will provide a reasonable level of protection against the possibility that two electronic devices, operating simultaneously, might interfere with each other.

The DX7 has been type tested and found to be in compliance with the design and manufacturing standards established for "Class B" computing devices. Compliance with the standards established by the FCC does not guarantee that interference will be eliminated. If your instrument is suspected of causing interference with other electronic devices, verification can be made by turning your instrument on and off. If the interference continues when your instrument is off, the instrument is not the source of the interference. If your instrument does indeed appear to be the source of the interference, one or more of the following corrective measures should be tried.

- (1) Relocate either the instrument or the electronic device that is being affected by the interference.
- (2) Utilize power outlets for the instrument and the device being affected that are on different branch circuits (different circuit breakers or fuses), or install AC line filters.
- (3) In the case of radio or TV interference, relocate the antenna; if the antenna lead-in wire is 300 ohm ribbon lead, change it to 75 ohm co-axial type cable (utilizing the necessary transformer/adaptors at either end, as required to match the cable).

If these corrective measures do not produce satisfactory results, please ask for suggestions or seek corrective measures by contacting your Authorized Yamaha Dealer or:

Music Marketing Group  
Service Division  
Yamaha International Corporation  
6600 Orangethorpe Avenue  
P.O. Box 6600  
Buena Park, CA 90622

If, for any reason, you should need additional information relating to radio or TV interference, you may find helpful a booklet prepared by the FCC: "How to Identify and Resolve Radio-TV Interference Problems." This booklet, (stock number 004-000-00345-4) is available from:

U.S. Government Printing Office  
Washington, DC 20402

<b>INTRODUCTION</b>	Inside front cover	<b>HOW THE DX7 CREATES SOUNDS</b>	23	<b>THE INTERNAL AND CARTRIDGE MEMORIES</b>	49
<b>PRECAUTIONS</b>	Inside front cover	Operators	23	Memory Protect	49
<b>CONVENTIONS</b>	3	Carriers, Modulators and FM	23	Storing individual voices to RAM cartridge	49
<b>"QUICK" BASIC FEATURES</b>	4	Algorithms	24	Saving all 32 internal memory voices to RAM cartridge	49
<b>SETUP</b>	12	The relationship between algorithms and the sound	24	Loading all 32 ROM or RAM cartridge voices to internal memory	49
Audio Output	12	Feedback is available in every algorithm	25	Transferring a single voice from one location to another in the RAM cartridge or internal memory	49
External Foot Controller Jacks	12	Envelopes and Envelope Generators	26		
Breath Controller	12	<b>PROGRAMMING VOICES: A TUTORIAL</b>	27	<b>ADVANCED PROGRAMMING NOTES</b>	51
MIDI Connectors	12	Two basic approaches to creating your own sounds on the DX7	27	Playing style and programming of dynamic control	51
AC Power	12	Programming a voice "from scratch"	27	Additional envelope considerations	51
Installation of Music Rack	12	Voice Initialization	27	Delayed turn-on using the envelopes	51
Additional Technical Installation Notes	13	What is initialization?	28	How to select an algorithm	51
		How to interpret the display	28	Learn to program by studying how acoustic instruments work	52
<b>PLAYING THE FACTORY PRESET VOICES</b>	<b>14</b>	Looking at the initial EG settings	28	There is more than 1 way to create a pitch	52
Playing the Internal Voices	14	Experimenting with the EG	29	Ensemble voices may differ from solo voices	53
Playing the Cartridge Voices	14	Learning to change the operator FREQUENCY settings	31	Breath controller applications and hints	53
		How to create Frequency Modulation: getting acquainted with the OPERATOR SELECT OUTPUT LEVEL and ON-OFF edit features	33	Special effects from [DATA ENTRY] while in PLAY mode	53
<b>FUNCTION MODE: SETTING OVERALL PERFORMANCE PARAMETERS</b>	15	Additional editing features: ALGORITHMSELECT KEYBOARD RATE SCALING and LEVEL SCALING	38	Reference sources on FM synthesis	54
Data Entry	15	LFO Modulation: The relationship between the "LFO" settings and the "MOD SENSITIVITY" settings, and how to program these	40	<b>MIDI: A STANDARD INTERFACE FOR REMOTELY PLAYING AND/OR PROGRAMMING MULTIPLE SYNTHESIZERS</b>	55
Function	15	Programming the remaining 4 operators	44	MIDI connections	55
Poly/Mono	16	Programming velocity sensitivity	45	Transmitting 32 voices from the Master to the Slave	56
Pitch Bend Range & Step	17	Naming and storing the newly created voice	45	Playing the Slave from the Master	56
Portamento Functions	17	Edit Recall "Emergency Voice Recovery" instructions	46	Transmitting individual voices from the Master to the Slave	56
Portamento & Glissando in Poly Mode	18			Using DX7 RAM cartridges to save DX9 voices	57
Sustain: Key Pitch Retain	18	<b>EDITING A VOICE</b>	47	Programming remotely with MIDI	57
Sustain: Key Pitch Follow	18	Analyzing and keeping a record of voices	48	Escaping from MIDI control	57
Glissando (Key Pitch Retain & Key Pitch Follow)	19			A special setup with two Masters and no Slave	57
Portamento & Glissando in Mono Mode	19			More information on MIDI	57
Fingered Portamento (and Glissando)	19			<b>MAINTENANCE AND TROUBLESHOOTING</b>	58
Full Time Portamento (and Glissando)	19			Cleaning	58
MIDI	20			Internal Memory Battery Backup	58
Edit Recall	20			If something goes wrong	58
Voice Initialize	20			<b>DX SYNTHESIZER GLOSSARY</b>	59
Cartridge Format	20			<b>SPECIFICATIONS</b>	63
Battery Check	20			<b>INDEX</b>	64
Modulation Wheel	21				
Foot Control	21				
Breath Control	21				
After Touch	21				

## CONVENTIONS

Nearly every button on the DX7 has several functions. Typically, the editing parameters are labeled in violet, the overall instrument functions are labeled in brown, and yet other functions are labeled in white or by reversing out the color of the button. Since this manual is not printed in full color, we have adopted the following conventions when referring to buttons. First, even though the button has several labels, we name only the button label which applies to the particular step being discussed. That button name will be bracketed to denote a button. In addition, in many cases we actually illustrate the button so there is no confusion as to which control is being discussed.

Lets look at a few examples to illustrate the conventions. Find the 32 numbered green buttons, and look at the upper left corner of that area. This is how we illustrate the first two buttons:

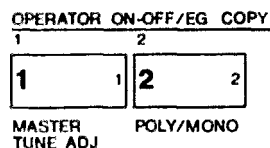

Both buttons are part of a group of 6 that are labeled in violet "OPERATOR ON-OFF/EG COPY". When the DX7 is in the EDIT mode, this label indicates that two different functions can be selected or activated by each button: (a) turning the output of an operator on or off, and (b) copying an envelope from one operator to another. Don't worry about what this means right now; we describe operators and envelopes and so forth later. Suffice it to say there are multiple uses for the buttons.

To continue, when we are discussing the left button in the context of (a) above, the printed reference to the button looks like this: [OPERATOR ON-OFF 1]. The same button, used in context (b), is described like this: (EG COPY 1]. When the DX7 is in the FUNCTION mode rather than the EDIT mode, the brown label below it applies instead of the violet label above it. In this case, the identical button now prepares the DX7 so that its master tuning can be adjusted, and the text describes the button like this: (MASTER TUNE ADJ.). When the DX7 is in PLAY mode, the green buttons serve as Voice Selectors. The label "Voice Selector" does not actually appear on the front panel, but when the text asks you to play internal or cartridge voice #1 by pressing Voice Selector [1], the #1 green button is the correct choice. As you can see, the text reference

changes to suit whichever of the button's several functions is under discussion, yet the button is always illustrated the same way:

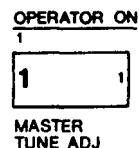

*In EDIT mode, press the [OPERATOR ON-OFF 1] button once to turn off operator #1 and again to turn it on.*

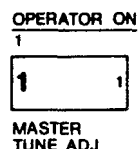

*In FUNCTION mode, press the [MASTER TUNE ADJ] button to set the [DATA ENTRY] slider so it can alter the tuning of the keyboard.*

We alternate between showing you the complete display window, including the LED voice number readout, and just the LCD portion of the display. There is no particular significance to this; the abbreviated display saves space on the printed page, and when we don't consider the voice number readout significant for an instruction, we omit it. Similarly in some cases we

*This illustration*

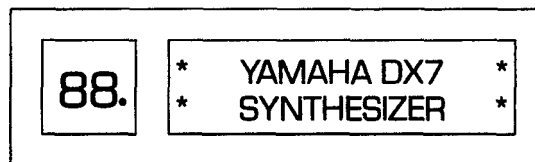

*is the same as this one*



illustrate two or more adjacent panel buttons, whereas in other cases we illustrate just one; the multiple buttons are to help you identify the one button we are discussing.

*This illustration*

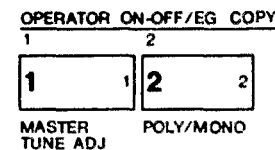

*is the same as this one*

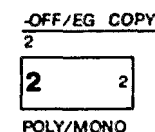



# "QUICK" BASIC FEATURES

4

**This section is provided for reference so you can quickly locate a control or access a function. It is meant more for review than as a learning tool. If this is your first time reading the manual, we suggest you either skim this section, or skip it altogether and go on to the section titled "Playing the Factory Preset Voices".**

The DX7 has 3 basic operating modes:

- **PLAY (MEMORY SELECT) Mode**

This is the "normal" performance mode in which pre-programmed voices can be selected.

- **EDIT mode**

This mode is used to edit an existing voice or to create an entirely new voice. Some of the "editing" functions do not alter the structure of the voice directly yet can have a major effect on the sound: for example, changing the sensitivity of a given voice to various modulation sources, transposing the voice, or changing the keyboard scaling.

- **FUNCTION mode**

This mode is used to adjust parameters that affect more than 1 voice, including the effect of the Modulation Wheel, Foot Controller, Breath Controller and After Touch (pressure sensitivity). FUNCTION mode also provides access to certain utility functions such as loading voices from a cartridge, saving voices onto a cartridge, checking the internal backup battery voltage, and initializing the instrument when you want to program a voice "from scratch" (which then automatically places the instrument in EDIT mode).

The DX7 front panel is unlike any conventional synthesizer. There are many more functions than buttons. It is important to bear in mind that the [DATA ENTRY] controls are assignable by means of the other buttons on the DX7. They take the place of the many knobs and sliders on conventional synthesizers. Another thing to remember is that, depending on the operating mode, the front panel controls may be used in different groupings. For example, in one place we may refer to VOICE SELECT button [1]. This is the same physical button as [OPERATOR ON-OFF 1] and the [MASTER TUNE] function selector. The 2 rows of 16 buttons at the right of the synthesizer are, among other things, the [VOICE SELECT] buttons. They include large white numerals [1] to [32], which apply when the buttons are used to select voices from the correspondingly numbered internal or cartridge memories. Many of the buttons include a small letter, number, or word at the right, inside edge.

These are used for labeling voices, as explained in the [VOICE NAME] button description.

*NOTE Refer to the illustration in the foldout front cover to identify the following features.*

### Rear panel connectors

These jacks include the line level output from the DX7 to an amplifier, foot control jacks, and MIDI interface connections. Refer to the "Setup" and "MIDI" sections of this manual for details.

### Volume and Data Entry Controls

#### VOLUME

This adjusts the overall output level at the rear panel OUTPUT jack and the front panel HEADPHONE jack. Some presets are inherently louder than others, and this can be used to compensate, or to do overall fades. If volume is too low, and the foot controller is plugged into the VOLUME jack, make sure the pedal is tilted flat for maximum level. It is also possible that amplitude modulation sensitivity has been programmed into a voice, in which case, to make the voice play louder, you may want to use the MODULATION WHEEL, BREATH CONTROLLER, FOOT CONTROLLER (plugged into the MODULATION jack), or the AFTER TOUCH (pressing harder after the key hits bottom). See the FUNCTION mode information on page 10 for more information on these modulation controls.

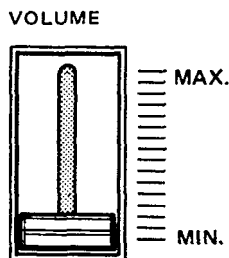

#### DATA

This group of a slider and two buttons serve as the main programming controls for the DX7. The two green buttons are single-step increment/decrement controls that do the same thing as the slider; the slider is faster for large changes and the buttons are better for small adjustments.

Each of the buttons has four different labels. The specific labels apply to different programming functions.

For example, if the DX7 asks you "are you sure", you can reply [NO] or [YES] with the left and right buttons. If you want to turn the glissando or some other programming function on or off, the [OFF] and [ON] labels apply — same buttons. If you want to change the frequency ratio or some other programming value by one unit at a time, the [-1] and [+1] labels apply. If you just want to move the cursor to a different position when naming a voice, the [<] (move left) and [>] (move right) labels apply. Usually you will be able to get the same effect by moving the adjacent slider up and down.

These controls are used primarily in the FUNCTION and EDIT modes, but also continue to modify the last selected FUNCTION parameter after returning to the PLAY mode (MEMORY SELECT INTERNAL or CARTRIDGE).

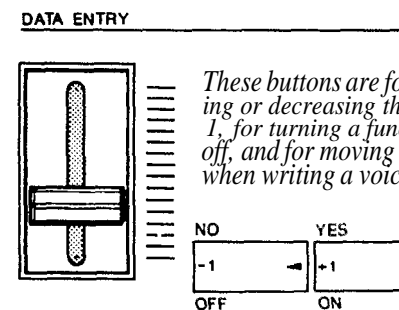

*These buttons are for increasing or decreasing the values by 1, for turning a function on or off, and for moving the cursor when writing a voice name.*

*This slider is used for rapid or large changes. Moving it all the way down and up covers the full range available for each parameter.*

### Mode Select and Editing Control Section

*These buttons let you see & change the MEMORY PROTECT status -*

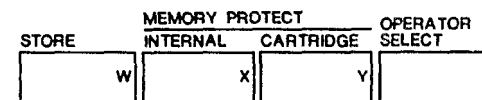

*This button is used for copying EG data and for storing individual voices on an internal or RAM cartridge memory*

*This button selects the current operator (the one being adjusted) when the synthesizer is in edit mode*

These buttons select the internal or cartridge memory and activate the PLAY mode; they also designate where individual voices may be stored

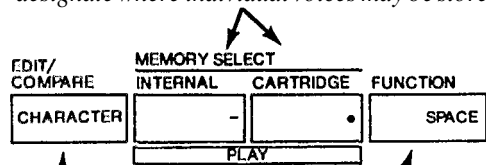

This button selects the EDIT mode and compares edited to original voices

This button selects the FUNCTION mode

## STORE

This button can be used to store whatever voice you have selected from cartridge or internal memory, or whatever voice you have just programmed. A voice can be stored into any of 32 internal memories or into any of the 32 memories in a RAM cartridge (provided the memory protect is turned off). This button is also used in conjunction with the [EG COPY] buttons for copying envelopes from one operator to another.

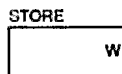

## MEMORY PROTECT

This pair of buttons enable you to set the internal and cartridge memories so that voices cannot be accidentally erased. When you press one of the buttons, the display shows you whether the associated memories are protected or not, and you can use the [DATA ENTRY] controls to change the status. Remember, however, that even if you turn off the cartridge memory protect, you still cannot save a voice on a ROM cartridge, nor can you save a voice if the On/Off switch on the RAM cartridge itself is set to the ON position.

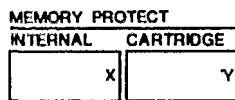

## OPERATOR SELECT

When you are programming or editing a voice, this button lets you select the operator which is to be modified, as shown in the upper right corner of the LCD display. (It sets the "current operator".) Remember that some programming parameters affect the overall voice, in which case this button will have no effect. You can only select from operators that are turned on, as shown by the six 1's or 0's in the top line of the programming display.



## EDIT/COMPARE-CHARACTER

This button places the DX7 in the EDIT mode, wherein you can edit any of the preset voices to change them slightly, or create completely new voices. Once in the EDIT mode, if you have changed a preset, then pressing this button lets you compare the edited version with the original. Once in the EDIT mode, if you have pressed the [VOICE NAME] button, then pressing this button [CHARACTER] and holding it enables you to press other buttons to enter the name of the voice in the display

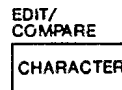

## MEMORY SELECT-PLAY

Pressing either of these buttons prepares the DX7 to PLAY any of the voices that are stored in the 32 INTERNAL memories, or in 32 memories of whatever CARTRIDGE is installed. Once the [INTERNAL] or [CARTRIDGE] source is designated, specific voices are accessed by pressing the VOICE SELECT buttons [1] to [32]. These buttons are also used to designate where individual voices can be stored, in the internal or cartridge memories, either after being created or edited, or when you want to rearrange the location of voices within these memories.

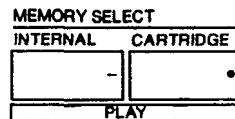

## FUNCTION

This button places the DX7 in the FUNCTION mode, which is used to program the entire keyboard rather than individual voices. This mode is also used for checking battery voltage, storing all the internal memories onto cartridge at once, and vice-versa, and a few other specialized functions. The functions designated by brown labels beneath other buttons are available after pressing this button.



## LED & LCD Display Panel

The LED (Light Emitting Diode) window indicates the number of the selected internal or cartridge voice memory. If the voice being played is in the midst of being edited, a decimal point appears to the right of the voice number. If you then press the [EDIT/COMPARE] button to hear the original voice before the editing, the LED numbers blink on and off. The LCD (Liquid Crystal Display) window displays the current status of the synthesizer, which may be the voice name and source, or the FUNCTION or EDIT mode parameter which was most recently selected. Refer to the paragraph "How to interpret the display," on page 28.

*LCD synthesizer status and voice name display*

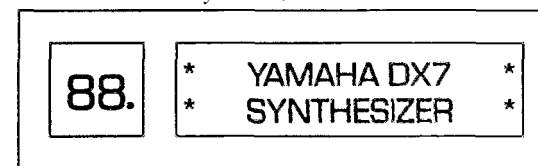

*Voice number LED display*

## Voice/Edit/Function select section

In PLAY mode, these 32 buttons select either the voices in the DX7's internal memory or on the external cartridge, as determined by the [MEMORY SELECT] buttons and indicated by the large numbers inside the buttons. However, these same buttons actually have multiple functions (up to 5 per button) which are accessible when the DX7 is placed in the FUNCTION and EDIT modes. All labels on these buttons are color and position coded: white numbers on the inside left of the buttons for PLAY mode, dark brown (reversed) type on the inside right of the buttons for naming voices, violet characters above the buttons for EDIT mode parameters,

and light brown characters below the buttons for FUNCTION mode parameters. A brief example for two buttons is shown here, with the specific references for these two buttons noted in parentheses:

*Violet EDIT mode parameters (Pitch and Amplitude Modulation Sensitivity)*

MOD SENSITIVITY		
PITCH	AMPLITUDE	
15 E	16 F	Reverse printed EDIT mode Voice Name character (E&F)
SAVE	LOAD	
CARTRIDGE		

White PLAY mode voice number (15 & 16)

*Brown FUNCTION mode parameters (SAVE all 32 voices from internal memory to cartridge, or LOAD 32 voices from cartridge to the internal memory)*

To simplify the presentation, we have further subdivided these buttons into the EDIT (violet) and FUNCTION (brown) groupings. Therefore, if you don't see the operational description that applies to what you're doing with a particular button as you read through the paragraphs on the EDIT parameters, check the corresponding button in the FUNCTION parameter descriptions (and vice-versa).

### Edit Parameter Selection (violet labels)

#### OPERATOR ON/OFF-EG COPY (1-6)

These buttons have two functions, (a) to turn individual operators on and off while you are programming a voice, and (b) to designate the operator into which you wish to copy an envelope. When you are in the EDIT mode, the top center portion of the LCD display shows 6 number 1's or 0's, corresponding to the 6 operators: 1=ON, and 0=OFF To toggle operator's output on or off, press the corresponding [OPERATOR ON-OFF] button. To copy the envelope, set the operator whose envelope you wish to copy as the current operator using [OPERATOR SELECT], then press [STORE] and hold it while pressing [EG.COPY] button for operator 1 to 6; all 4 rates and levels are instantly copied.

OPERATOR ON-OFF/EG COPY					
1	2	3	4	5	6
1	2	3	4	5	6
MASTER TUNE ADJ	POLY/MONO h	RANGE PITCH BEND	STEP	MODE PORTAMENTO	GLISSANDO

#### ALGORITHM

In EDIT mode, this button activates the [DATA ENTRY] section so its controls can be used to select any of the 32 available algorithms.

ALGORITHM
7
TIME

#### FEEDBACK

In EDIT mode, this button activates the [DATA ENTRY] section so its controls can be used to alter the amount of feedback in whatever algorithm is displayed from none (0) to a maximum value (7).

FEEDBACK
8

#### LFO

In EDIT mode, these 6 buttons each activate the [DATA ENTRY] section so it can be used to program or edit individual voices with regard to Low Frequency Oscillator modulation. When the modulation is used to change the pitch, vibrato can be obtained. When it is used to change the amplitude of a carrier, tremolo may result; changing the amplitude of a modulator can create "wah-wah."

LFO WAVE	SPEED	DELAY	PMD	AMD	SYNC
9	10	11	12	13	14
EDIT RECALL	VOICE INIT				BATTERY CHECK

#### WAVE

This lets you set the LFO waveform to any of the following: triangle, sawtooth down, sawtooth up, square, sine, sample & hold.

#### SPEED

This lets you adjust the LFO frequency in a 100 step range, 0 being the slowest and 99 the fastest.

#### DELAY

This lets you set the LFO so modulation does not begin until after a specified time after you press the key, 0 being no delay, and 99 the maximum delay.

#### PMD

This lets you set the Pitch Modulation Depth. This is the amount of modulation that will be applied to shift the pitch of whatever notes are played (according to the set waveform and speed). However, the modulation can only affect the note if the pitch modulation sensitivity is set to a value greater than zero (see [MOD SENSITIVITY-PITCH]).

#### AMD

Like PMD, this button lets you set the Amplitude Modulation Depth, the amount of modulation that will be applied when you play but it affects the amplitude (level), not the pitch. Likewise, the modulation can only affect the note if the Amplitude modulation sensitivity is set to a value greater than zero (see [MOD SENSITIVITY-AMPLITUDE]). The same LFO speed and waveform controls both the [PMD] and [AMD].

#### SYNC

This lets you turn on or off the LFO Key Synchronization. When Sync is ON, the LFO is automatically reset to the beginning of the selected waveform each time you play a note. When sync is OFF the LFO waveform continues, and when you play a note, the result will vary depending on where the LFO is in the cycle. The effect can be easily detected at low LFO frequencies (SPEED settings below 10).

#### MOD SENSITIVITY

In EDIT mode, this pair of buttons activate the [DATA ENTRY] section so it can be used to set the sensitivity of individual voices to LFO modulation. The modulation sensitivity is like a master control for all the modulation, whether it is "built into" the voice with the adjacent [AMD] and/or [PMD] buttons, or whether it comes from the "real time" modulation controls such as the Modulation Wheel, the Foot Control, the Breath Control or the keyboard After Touch. If the Pitch or Amplitude Modulation Sensitivity is set at zero, then none of the external controllers can affect the voice, regardless of how much Depth is set with their FUNCTION mode controls.

MOD SENSITIVITY	
PITCH	AMPLITUDE
15 E	16 F
SAVE	LOAD
CARTRIDGE	

**PITCH**

This lets you set the sensitivity of the voice to LFO pitch modulation from no sensitivity (0) to maximum (7). One setting affects the overall voice.

**AMPLITUDE**

This lets you set the sensitivity of the individual operators in a voice to amplitude modulation from no sensitivity (0) to maximum (3).

**OSCILLATOR**

In EDIT mode, these 4 buttons each activate the [DATA ENTRY] section so it can be used to program or edit the frequency of individual operators in a voice.

OSCILLATOR			
MODI / SYNC	FREQUENCY COARSE	FREQUENCY FINE	DETUNE
17 G	18 H	19 I	20 J
RANGE MODULATION WHEEL	PITCH	AMPLITUDE	EG BIAS

**MODE/SYNC**

The DX7 toggles between two different programming functions when you press this button successive times. One function, MODE, enables you to set the current operator so it tracks the keyboard pitch (this is Frequency Ratio Mode), or so the keyboard does not affect that operator's frequency (Fixed Pitch Mode). The other function, SYNC, enables you to set the operator so its "oscillator" begins at the start of the sine wave cycle each time you play a note. When Oscillator Key Sync is OFF, the sine wave continues so that subtle differences will occur even when you play the same note repeatedly. You may not be able to hear much difference in some voices.

**FREQUENCY COARSE**

This lets you make large changes in the current operator's frequency. It operates in conjunction with the adjacent [FREQUENCY FINE] button. Assuming the Fine setting is all the way down, then in Frequency Ratio mode the ratio increases from 0.50 to 1.00 and then by integer values to a maximum of 31.00. In Fixed Frequency mode, this lets you set the beginning frequency to 1 Hz, 10 Hz, 100 Hz, or 1000 Hz.

**FREQUENCY FINE**

This lets you make small changes in the current operator's frequency. With this control, the maximum available increase in frequency is just under the next available "Coarse" setting (1.99 times "F COARSE").

**DETUNE**

Detune is like a "super fine" frequency adjustment for each operator. You can shift the frequency over a range of -7 to +7. Mild detuning can enrich the harmonic structure and more closely simulate the imperfect nature of a real acoustic instrument. Maximum detuning between carriers can be used to cause "beating" within a voice to help simulate chorusing or multiple instrument effects.

**EG**

In EDIT mode, this pair of Envelope Generator buttons activate the [DATA ENTRY] section so it can be used to program or edit the envelopes of individual operators in a voice. 4 parameters are programmable with each button, and the range of adjustment is from the minimum of 0 to a maximum of 99 (100 steps).

EG	
RATE	LEVEL
21 K	22 L
RANGE FOOT CONTROL	PITCH

**RATE**

Pressing this button 4 successive times gives you access to programming the 4 rates in the EG.

**LEVEL**

Pressing this button 4 successive times gives you access to programming the 4 levels in the EG.

**KEYBOARD LEVEL SCALING**

In EDIT mode, these 3 buttons each activate the [DATA ENTRY] section so it can be used to program or edit individual operators so their output levels change as you play up and down the keyboard. Each operator can be programmed to have any of 4 curves on either side of an adjustable break point. The scaling can be used to make the tone and/or volume change as you move to different octaves, for more realistic acoustic instrument

simulations. Extreme settings can also be used for "split keyboard" effects.

KEYBOARD LEVEL SCALING		
BREAK POINT	CURVE	DEPTH
23 M	24 N	25 O
AMPLITUDE	EG BIAS	RANGE BREATH CON

**BREAK POINT**

The level can be scaled up or down differently on either side of the Break Point in the curve. You can set this break point from 1-1/3 octaves below the lowest key on the keyboard (A -1) to 2 octaves above the highest note on the keyboard.

**CURVE**

Pressing this button successive times gives you access to programming the scaling curve for the left or right side of the break point. Either curve may then be set to any of four characteristics: negative linear, negative exponential, positive exponential, positive linear. The linear curves will give you a more exaggerated boost or cut in level at any given depth setting as you play up and down the keyboard, where as the exponential curves tend to give more natural sounding scaling.

**DEPTH**

Pressing this button successive times gives you access to programming the depth of the selected left or right curve. At a minimum setting (0), there is no scaling, and you can increase or decrease the level up to a maximum of 99. To increase the level, there has to be some "headroom," some operator output, level available for increase. For example, if the OPERATOR OUTPUT LEVEL is set at 90, and a positive (+) curve is set, the greatest curve depth that can be achieved is 9. This is because  $90 + 9 = 99$ , and 99 is the maximum possible output level. While the curve depth can be set to a value greater than 9, there will be no more effect than if it were set at 9; if you want more boost as you move up or down the keyboard, then you'll have to set the Operator Output Level at a lower value so that more "headroom" is available for the scaling to boost the level to the maximum of 99. For your reference, a -L1N curve set to a depth of 99 produces a roll-off of 22 dB per octave.

## KEYBOARD RATE SCALING

In EDIT mode, this button activates the [DATA ENTRY] section so its controls can be used to program or edit each operator so its envelope rates become faster as you move up the keyboard. The minimum setting (0) produces no scaling, so rates R1, R2, R3 and R4 are the same on all keys, whereas the maximum setting (7) speeds up the rates more and more as you move from the lowest to the highest notes. The scaling is useful for simulating the natural scaling of envelope rates that characterizes many acoustic instruments.

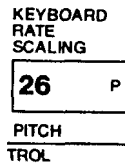

## OPERATOR

In EDIT mode, this pair of buttons activate the [DATA ENTRY] section so its controls can be used to change the output level of each of the 6 operators.

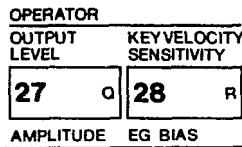

## OUTPUT LEVEL

This button gives you "direct" programming access to setting the output level of each operator from no output (0) to maximum (99). Remember that the [OPERATOR ON- OFF] buttons only have an effect while you are programming a voice so if you want to keep an operator turned off when you store a voice (because you don't need its effect), then you have to set its output level to zero. The scaling is such that half the numerical value (i.e. 50 instead of 99) produces much less than half the audible volume.

## KEY VELOCITY SENSITIVITY

This button lets you program the velocity "touch" sensitivity of each operator so that the faster you press a key the greater the output level. This function interacts with the [OUTPUT LEVEL] function so that, if you set a maximum [KEY VELOCITY SENSITIVITY] of 7, and then press a key very slowly there will be virtually no output from the operator;

press that key fast, and you'll get the maximum output level you have set with [OUTPUT LEVEL]. If the operator is a carrier, this function causes the notes to be louder when you play faster, whereas if the operator is a modulator, the timbre changes as you play faster. This is the parameter that determines why some preset voices have touch sensitivity and others do not.

## PITCH EG

In EDIT mode, this pair of buttons activate the [DATA ENTRY] section so its controls can be used to change a special envelope generator that alters the frequency of each note you play. The Pitch EG affects all 6 operators equally. The "shape" of the envelope follows the same rules as the individual operators' level envelopes, with four rates and four "levels", although the levels actually refer to frequency excursions. The Pitch EG can be used for automatic pitch bending effects, including the slight pitch changes that occur with plucked strings. However, the 8 octave range of this feature permits all sorts of special effects to be achieved.

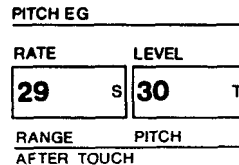

## RATE

Pressing this button 4 successive times gives you access to programming the 4 rates in the EG.

## LEVEL

Pressing this button 4 successive times gives you access to programming the 4 "levels" in the EG. If you don't want any pitch bend, then all 4 levels should be programmed to a value of 50. When you set a level below 50, the pitch decreases (a zero value is down 4 octaves from the note you play), and when you set it above 50, the pitch increases (a 99 value is up 4 octaves). The [PITCH] wheel can further add 1 octave above or below this "automatic" pitch bend.

## KEY TRANSPOSE

In EDIT mode, this button DOES NOT RELY ON THE [DATA ENTRY] section. Instead, it activates the keyboard so it can be used to transpose the pitch of the entire voice. The "normal" pitch of the keyboard is set

so that middle C (C3) is 262 Hz. When you press [KEY TRANSPOSE], the first key you then press becomes the pitch which is produced when you play middle C (you won't hear anything until you play a subsequent note). The transposition range is great enough that middle C can be set to sound the pitch of any note for 2 octaves up or down.

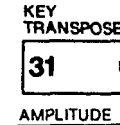

## VOICE NAME

In EDIT mode, this button DOES NOT RELY ON THE [DATA ENTRY] section either. Instead, it converts the [EDIT/COMPARE] button to the [CHARACTER] button so you can enter up to 10 letters, numbers, spaces or punctuation marks to name a voice. Once you've pressed [VOICE NAME], you hold down the [CHARACTER] button and then press each character you wish to enter (indicated by the reversed dark brown type in the right corner of most buttons). A flashing "cursor" shows you the position of the character you are about to enter, and you can move the cursor without entering a character by pressing the [<] and [>] buttons. You can "write" new-characters on top of previous names, or erase a name by using the [CHARACTER] and [SPACE] buttons.

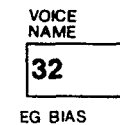

## Function Control Parameters (light brown labels)

### MASTER TUNE ADJ

In FUNCTION mode, this button activates the [DATA ENTRY] slider so it can be used to tune the overall pitch of the keyboard plus or minus 75 cents. (The [-1] and [+1] DATA ENTRY buttons are not used in this case because the tuning adjustment is already very fine.) Larger pitch shifts can be programmed into a voice by using the [KEY TRANSPOSE] button or by resetting the frequencies of all operators.

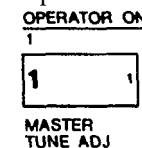

**POLY/MONO**

In FUNCTION mode, this button activates the [DATA ENTRY] section so its controls can set the keyboard to play polyphonically (up to 16 notes simultaneously) or monophonically (one note at a time).

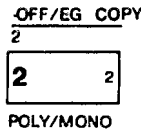

**PITCH BEND**

In FUNCTION mode, this pair of buttons activate the [DATA ENTRY] section so its controls can program the range and "smoothness" of the [PITCH] wheel. If the RANGE is set to zero, the [PITCH] wheel will have no effect.

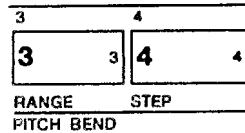

**RANGE**

This lets you program the maximum amount of pitch bend from no effect (0) to plus or minus an octave (12 semitones). The numbers in the programming display indicate how many semitones the wheel can change the pitch in each direction. The [RANGE] may only be adjusted when the [STEP] is set to zero. If [STEP] is at 1 or higher, the [RANGE] is automatically fixed at 12 semitones. Remember that a zero setting turns off the pitch bend.

**STEP**

This permits you to set the size of the increments by which the wheel changes the pitch. A setting of zero (0) will cause perfectly smooth pitch bending. Each unit above zero represents the number of semitones by which the pitch will "jump" as you move the wheel. The maximum setting of 12, for example, will cause the wheel to change the pitch in a single, 1 octave jump.

**PORTAMENTO**

In FUNCTION mode, these 3 buttons activate the [DATA ENTRY] section so its controls can be used to set portamento (glide) and glissando (stepped glide) effects, and to control certain sustain characteristics of the keyboard. The particular effects available will

change, depending on whether the DX7 is in Poly or Mono mode.

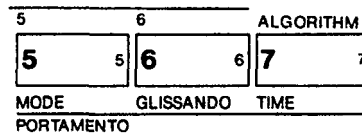

**MODE**

When the keyboard is in Mono mode, this lets you select "FINGERED PORTA" or "FULL TIME PORTA" functions. Fingered Portamento is a glide that occurs only when you hold one key down and then press another while holding the first. Full Time Portamento gives you the glide from one note to the next even when you release one key before pressing the next.

When the keyboard is in Poly mode, this lets you select "SUS-KEY P FOLLOW" or "SUS-KEY P RETAIN". In Sustain-Key Pitch Follow mode, if you play a note or chord and then play another note or chord, the sustain from the original note/chord glides to the pitch of the most recently played note/chord. In Sustain-Key Pitch Retain mode, the pitch of the new note or chord glides from that original pitch(es) without disturbing the sustain of the original note or chord.

**GLISSANDO**

When the Glissando feature is turned ON, the glide in pitch occurs in discrete steps. This effect is best heard with a slower rate and when two widely separated notes are played one after the other. When Glissando is turned OFF then normal Portamento (continuous glide) is available.

**TIME**

This sets the time of the Portamento or Glissando effect. A setting of 0 produces no effect, while a setting of 99 produces the longest (slowest) pitch changes. This is contrary to the operation of most DX7 rate controls whose fastest setting is 99. You don't have to change the Time to zero to turn the effect off. Instead, once an effect is selected, it can also be turned On and Off by plugging an FC-4 or FC-5 foot pedal into the PORTAMENTO jack on the rear panel; stepping on the pedal then turns ON the portamento.

*NOTE: For [MIDI] information, see page 55.*

**EDIT RECALL**

This button activates the DATA ENTRY [YES] and [NO] buttons so they can be used to recall a voice that you had been editing in the event you inadvertently leave the editing mode and select another voice to play. To "recapture" or recall the edited voice, press [FUNCTION], then [EDIT RECALL], then answer [YES] to the two display prompts "Edit Recall?" and "Are You Sure?"

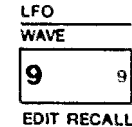

**VOICE INIT**

The Voice Initialize button lets you create a neutral starting point for programming a new voice. After you select VOICE INIT from the FUNCTION mode by pressing the button and then answering [YES] to the two display prompts, the DX7 sets itself to the EDIT mode. A neutral "voice" then exists with no modulation, algorithm 1, operator 1 output level at 99 and all others off, "square" envelopes, and all frequency ratios at 1.00.

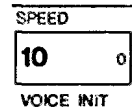

**CART FORM**

*NOTE: Since the format of a RAM cartridge used for other purposes, such as DX1 performance memories, will vary from that of a cartridge used for voice memories, make sure you observe the following procedure when storing or saving DX7 internal voices into such a cartridge.*

The Cartridge Format button lets you "initialize" all the voices in a RAM cartridge much like you initialized the single voice in the edit buffer using the [VOICE INIT] button. It is like a cartridge "eraser." To use this function you first have to turn off the hardware memory protect switch on the cartridge, then turn off the software [MEMORY PROTECT-CARTRIDGE] function on the DX7. Then press [CART FORM] and answer [YES] to the two displayed prompts. **THINK BEFORE YOU DO THIS; IF THERE WERE ANY VOICES YOU WANTED ON THAT CARTRIDGE, THEY WILL BE GONE FOREVER.** (You can load one or more cartridge

voices into the DX7 internal memory and then format it (you like.) You cannot format a ROM (factory preset) cartridge.



### BATTERY CHECK

In function mode, this button causes the display to show the voltage level of the battery which preserves the DX7 internal voice and programming memories when power is turned off. The acceptable range is 2.3 to 3.5 volts. If the battery is below 2.2 volts, contact your Yamaha dealer to arrange for replacement; this is NOT a do-it-yourself repair.

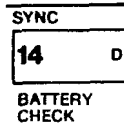

### CARTRIDGE

This pair of buttons sets the DX7 to transfer a full 32 voices between the internal and the cartridge memory. Before voices can be transferred to a cartridge or TO the DX7, the corresponding (MEMORY PROTECT) features must be turned off. (Individual voices can be transferred by first using the Play mode to "pick" the voice, then pressing the [STORE] button and whatever Voice Selector you like from 1 to 32.)

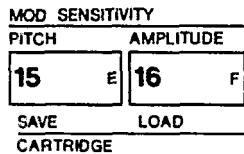

### SAVE

Pressing this button in FUNCTION mode stores all 32 internal memories to a RAM cartridge. You have an opportunity to cancel the command by answering [NO] to either displayed prompt; otherwise any voices in the cartridge will be erased when the transfer occurs. The display shows "Under Writing" for 20 seconds while the voices are being "written" to the cartridge.

### LOAD

Pressing this button in FUNCTION mode loads 32

RAM or ROM cartridge voices into the DX7 internal memories. Again, you have to answer [YES] twice before the voices are loaded (which erases any existing voices in the internal memories). The actual transfer occurs instantaneously

### MODULATION

The bottom row of 16 Function buttons is used to set the Modulation available from 4 control sources: the MODULATION WHEEL, FOOT CONTROL, BREATH CONTROL and key AFTER TOUCH. Since the 4 groups are identical in nature, we'll cover the buttons just once. Pressing any of these buttons activates the [DATA ENTRY] section so you can program different settings.

*NOTE: if the Amplitude or EG Bias is turned On, with a low Range setting, certain voices may be inaudible or nearly so due to their high modulation sensitivity.*

OSCILLATOR			
MODE/ SYNC	FREQUENCY COARSE	FREQUENCY FINE	DETUNE
17 G	18 H	19 I	20 J
RANGE	PITCH	AMPLITUDE	EG BIAS
MODULATION WHEEL			

### RANGE

This lets you program the amount of modulation from none (0) to a maximum value (99). Bear in mind, however, that the Pitch and Amplitude modulation "range" may be zero (off) even if this control is set at 99 unless the particular voice being played includes some modulation sensitivity. Since sensitivity differs between voices, the identical Range setting may produce different results with different voices.

### PITCH

This lets you turn On LFO modulation of the voice's pitch for vibrato-like effects.

### AMPLITUDE

This lets you turn On LFO modulation of the amplitude (level) of those individual operators within a voice that are programmed to be sensitive to it. The effect may therefore be tremolo-like, or wah-like depending on whether a carrier or modulator is being modulated.

### EG BIAS

This lets you directly control the operator output

level with the corresponding modulation control (Foot, Breath, etc.). In this case, the LFO is not involved. Again, this will produce changes in brilliance or volume or "wah" depending on the amplitude sensitivity programmed into each operator in the voice.

### Voice Cartridge socket

This socket accepts the ROM cartridges which each hold 64 pre-programmed voices (two are supplied with the DX7), or the RAM cartridges which each hold 32 user-programmed voices. A protective door automatically swings away when a cartridge is inserted. The cartridges have a slot in their end connector, and the socket has a keyway so that the cartridges can only be inserted fully when properly oriented. If a cartridge does not seat properly turn it around and try again. DO NOT FORCE a cartridge into place.

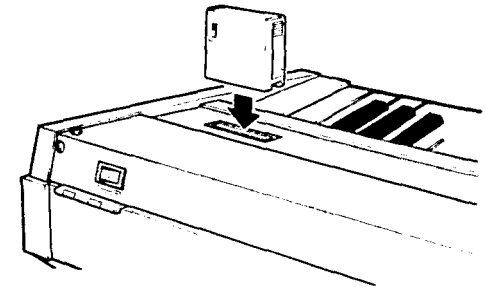

### Power Switch

This rear panel switch turns power on, permitting the DX7 to be played and/or programmed. The internal voices are preserved even when power is turned off, so long as the internal battery can deliver at least 2.3 volts (which can be verified by selecting the FUNCTION/Battery Check mode).

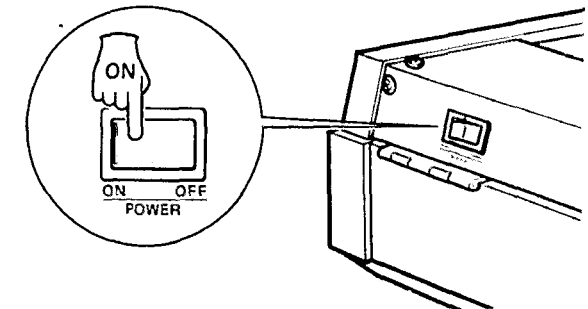

## Keyboard

This is a 61-key keyboard which has initial (velocity) and after (pressure) sensitivity, although these parameters must be programmed into the voice in order to be useable. The keyboard has 16-note polyphonic capability or can be switched to monophonic mode. The overall keyboard pitch produced can be altered  $\pm 75$  cents using the Master Tune Adjust parameter in FUNCTION mode, and the pitch of a particular voice can be transposed over a 4 octave range using the Key Transpose parameter in EDIT mode. Each voice also may have an inherently higher or lower pitch depending on the frequency settings of components within the voice (the Operators).

## Modulation Wheel

The Modulation wheel permits you to introduce LFO modulation of pitch and/or amplitude and/or EG bias as you move the wheel away from you. The range and nature of the effect obtained depends on several factors (1) how the Modulation Wheel parameters are set in FUNCTION mode, and (2) whether the voice has modulation sensitivity programmed into it; if either factor is not set appropriately the wheel will have no effect.

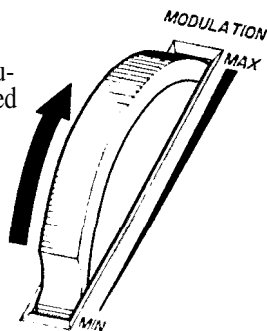

## Pitch Bend Wheel

The Pitch Bend wheel permits you to shift the keyboard pitch up and down; the range of this shift depends on how far the wheel is deflected from the spring-return center position, and on the FUNCTION mode [PITCH BEND RANGE] setting, with a maximum range of plus or minus one octave. The smoothness depends on the [PITCH BEND STEP] setting.

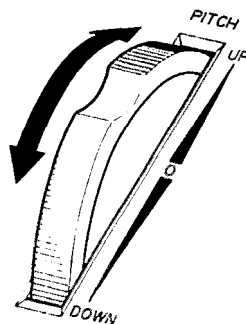

## Headphone & Breath Controller Jacks

The Headphone jack lets you listen without an external amplifier/speaker system by plugging in almost any pair of mono or stereo headphones that has a standard 1/4" (6.3 mm) diameter phone plug. The Breath Controller jack accepts the miniature stereo phone plug from a Yamaha BC-1 Breath Controller, which may be used to introduce LFO modulation or EG bias into most voices depending upon how the FUNCTION mode Breath Control parameters are set, and on whether modulation sensitivity is programmed into the voice. (If they are not set appropriately the BC-1 will have no effect.)

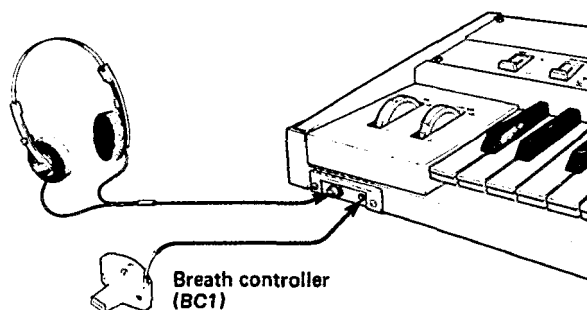



# SETUP

12

*NOTE: Do not turn power On until all other connections have been made.*

## Audio Output

The DX7 has a built in headphone amplifier, so stereo headphones may be plugged into the front panel jack. However, the instrument does not have a built in power amplifier, and thus requires an external amplifier/speaker system. The OUTPUT jack is suitable for connection to any unbalanced, low line level input. This includes the input of the self-powered speaker systems, and the 600 ohm or higher impedance line inputs of any Yamaha mixer. Remember (hat the audio output level not only depends on the VOLUME setting, but also on the selected voice, the playing style, and the position of the foot control if it is plugged into the VOLUME jack.

Use a single conductor shielded cable with a standard 1/4" (6.3 mm) tip/sleeve phone plug. Coiled guitar cords are not recommended since they typically degrade the high frequency response more than a straight cord.

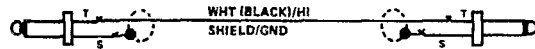

*Standard guitar cord, 20 feet maximum recommended length.*

The low impedance XLR inputs of Yamaha mixers may be used with an adaptor cable or a "direct box," as explained in the technical notes at the end of this section.

## External Foot Controller Jacks

There are 4 phone jacks designed for use with external foot controls. The VOLUME and MODULATION jacks each accept a Yamaha FC-3A foot pedal, which has a tip/ring/sleeve (stereo type) phone plug. The PORTAMENTO and SUSTAIN jacks each accept a Yamaha FC-4 or FC-5 foot switch, which has a tip/sleeve phone plug. None of these jacks needs to be used for normal operation of the DX7, but if the foot controllers are used, be sure you plug in the proper type of controller. The pictorial diagrams on the rear panel should make this clear.

## Breath Controller

The optional Yamaha BC-1 Breath Controller is a pressure transducer that is designed for use with this synthesizer. Its miniature tip/ring/sleeve phone plug

goes into the BREATH CONT. jack on the front of the DX7; DO NOT plug anything else into this jack.

## MIDI Connectors

These multi-pin DIN connectors are for the Musical Instrument Digital Interface system (MIDI), a standard adopted by several leading synthesizer manufacturers. MIDI allows the DX7 to remotely control (or be controlled by) other keyboards, sequencers and computer interfaces. See the "MIDI" section of this manual for additional information.

## AC Power

Plug the DX7 power cord into any 120 volt, 50 or 60 Hz grounded (3-prong) AC receptacle. It draws 40 watts maximum. When using the DX7 with an amplifier or mixer that has an unbalanced input, it is a good idea to plug both units into the same AC receptacle box or the same "leg" of the AC service. This will reduce the chance of hum.

After all connections have been made, turn down the mixer or amplifier volume as a precaution. Then turn ON the POWER switch located at the rear of the instrument (on the right side viewed from the keyboard). The display panel will look like the illustration here for a few seconds, and will then change to display the mode which had been engaged before the DX7 was last turned off.

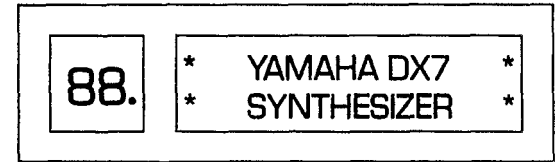

## Installation of Music Rack

The music rack which comes with the DX7 fits into two sockets on the rear panel (see diagram).

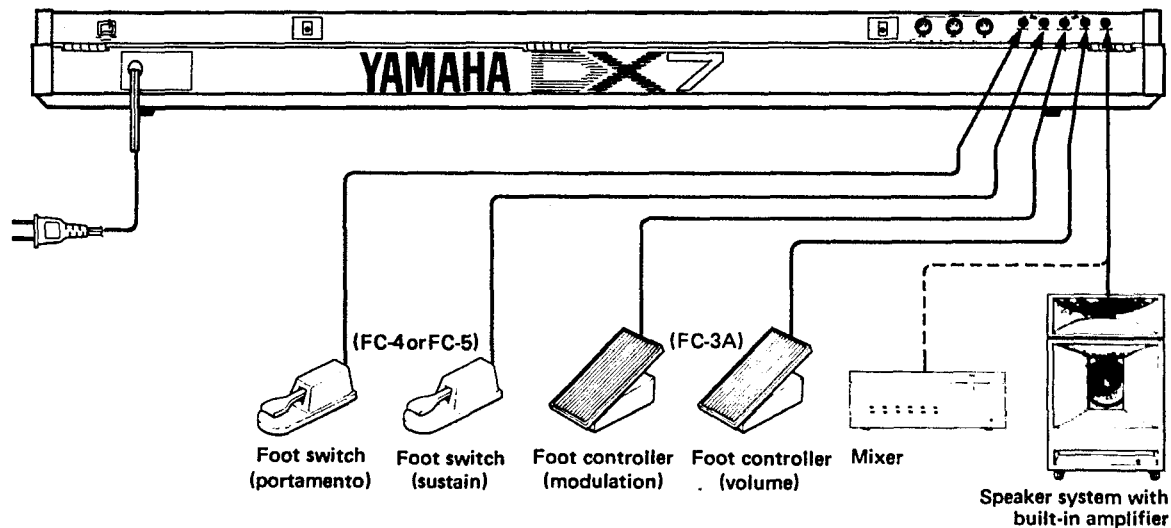
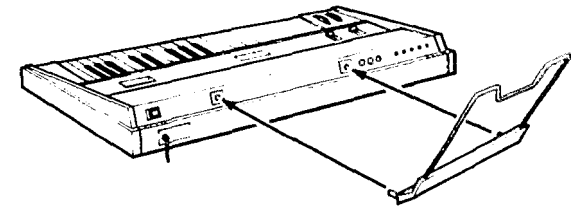

### Additional Technical Installation Notes

When connecting the DX7 to an amplifier or mixer, a maximum unbalanced cable length of 20 feet will reduce susceptibility to hum, noise, and high frequency losses; if a longer cable is needed, utilize a "direct box" which uses a transformer or amplifiers to convert the output to a balanced line, and then run 2-conductor shielded cable with XLR-3 or 1/4" Tip/Ring/Sleeve phone plugs to a balanced input on the mixer or amplifier.

If the cable length is under 20 feet, but the mixer or amplifier input requires an XLR connector, a direct box may not be necessary; a simple adaptor cable will often do the job, so long as complex grounding problems don't cause excessive hum. To adapt the phone jack OUTPUT of the DX7 to an XLR input, first check the manual on the other equipment to see which pin of its XLR is the "hot" or "signal" pin. In Yamaha equipment, pin 2 is "hot." Cut the phone plug off one end of a standard guitar-type cable, and connect the center conductor to XLR's "hot" pin. Then wire the shield to the other two pins of the XLR; if hum is a problem, cut the shield connection to pin 1 of the XLR.

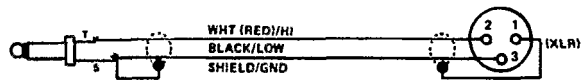

*Phone-to-XLR adaptor cable.*

The nominal output level is -20 dBm (77.5 mV), although the actual level depends on the voice, the VOLUME setting, and how many notes are being played at once. The OUTPUT jack will drive low impedance (600 ohm) or higher impedance inputs. Maximum output may be considerably higher; since power amplifiers' nominal input levels are those levels that drive the amplifier to maximum power, an amplifier rated at 0 dBm or +4 dBm input level may be well matched to the DX7 output. Mixers with adjustable input sensitivity may have to be set anywhere from -20 to +4 dBm nominal, depending on the selected voice, the playing style, and the DX7 VOLUME setting.

As is the case with any electric or electronic instrument, the AC power receptacle should be checked for correct voltage and polarity. To find out what to do about operation with power mains that do not meet these specifications, contact a Yamaha dealer or authorized Yamaha DX service center.

# PLAYING THE FACTORY PRESET VOICES

## Playing the Internal Voices

1. If the DX7 happens to be on, turn it off. Then turn it back on while observing the display window. This will let you see the initial displays we are about to describe. (In the future, you won't have to turn off the instrument just to change modes.) When you first turn on the DX7, the LCD display will briefly show:

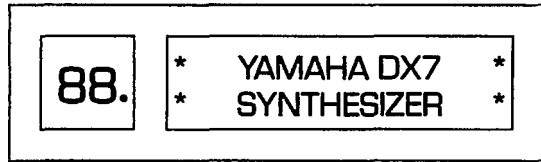

The number 88 may or may not appear in the LED voice number display; in any case, after a few seconds, the display will change. However, we don't know what it will show when it changes.

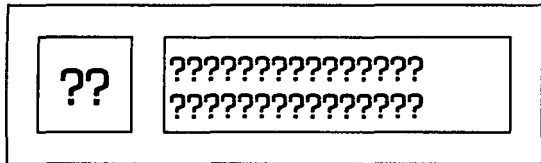

*NOTE: A voice number will be shown in the RED window, but its number will depend on the voice that was last selected before the DX7 was turned off; we have used question marks even though an actual number will appear. Similarly we placed question marks in the LCD display because we don't know what will show in that window... it could be an internal (INT) voice name, a cartridge (CRT) voice name, or a function; again, it depends on that which was last used before power was turned off. In order that you can explore the internal voices and find out for yourself what they are, do the following:*

2. If you are using an amplifier/speaker system with the DX7, make sure that system is turned on and its volume controls are set appropriately. Whether you're using an external amplifier/speaker system, or the DX7 headphone jack and a pair of headphones, be sure to set the DX7 VOLUME control so there is some output; mid scale is a good starting point.

*Set the VOLUME so you'll be able to hear something*

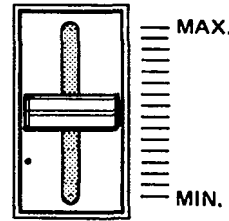

3. Enter the PLAY mode by pressing the [MEMORY SELECT-INTERNAL] button, then select the #1 internal memory by pressing the [1] button.



Press this... Then... Press this

The display will change to show the new voice

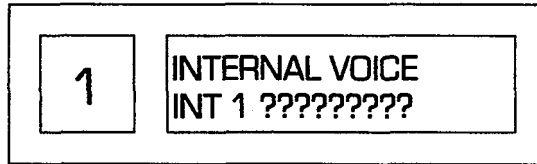

There won't be question marks. However, the 32 internal memories may have been loaded with any of the 4 factory preset banks, something you or another musician left in memory or something the dealer placed there during checkout of your instrument prior to delivery. Therefore, we don't know what voice name will appear. The LCD display "INT 1" is really redundant here; it tells you that internal voice 1 is selected, which you can read from the top line of the LCD window and the red LED voice number display. (Later, when you are editing voices, the "INTERNAL VOICE" and "INT 1" areas will have different labels, and the red LED display will become an important reminder of the voice you have selected.)

4. Play the keyboard, and explore this voice. In fact, explore all the voices in the internal memories. You can do this by simply pressing selector buttons [1] through [32]. You don't have to press [MEMORY SELECT-INTERNAL] each time.

*NOTE Don't worry if you try to play a chord and the keyboard acts monophonically rather than polyphonically. This simply means the synthesizer is in monophonic mode, and the change to polyphonic mode is described in the following section of this manual.*

*AVOID FRUSTRATION Although we encourage you to explore all of the DX7 features on your own, please try not to jump ahead and press buttons other than voice selectors 1 to 32 at this time. This can place the DX7 in a different operating mode so try to resist. There's nothing wrong with pressing any buttons — you can't damage the instrument — but if you do go off on your own, these instructions may no longer make sense. You may think something is wrong with the instrument, and to get back to anything recognizable you will have to start all over again. Bear with these step by step instructions the first few times, and then after you really know what the controls do, you can go ahead and have fun.*

## Playing the Cartridge Voices

1. Locate the cartridge labeled "DX7 VOICE ROM" on the top, with a large numeral "3" on one side of the cartridge. Slide the switch on that cartridge upward (away from the connector) to gain access to the 32 voices in bank A. These are labeled "Master Group".
2. Insert the cartridge into the slot near the right side of the keyboard, orienting it so its switch faces away from the keyboard.
3. Select the cartridge voice called "BRASSHORNS", which is in location #A-5 of the DX7 VOICE ROM #3 cartridge. Do this by pressing the [MEMORY SELECT-CARTRIDGE] button and then the [5] button.

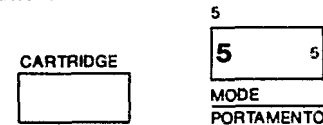

Press this... Then press this

The display will change to show the new voice

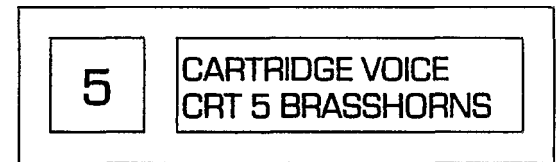

## FUNCTION MODE: SETTING OVERALL PERFORMANCE PARAMETERS

*NOTE Yamaha reserves the right to continue to refine and update factory preset voices. For this reason, some ROMs may have this voice in a different location, or may have a different voice altogether. Refer to the notes which are packaged with the ROMs.*

- Play the keyboard, and explore this voice. Observe the change in the sound when you press the key gently and when you hit it hard (not all voices have this touch sensitivity programmed into them). You'll probably want to play all the voices in Bank A of this ROM cartridge. You can do this by pressing selector buttons [1] through [32]; you *don't* have to press [MEMORY SELECT-CARTRIDGE] each time.

*NOTE At this point, the voice may not sound "fight" or some of the features of the synthesizer may not appear to work. This is likely to be due to the settings of the FUNCTION controls, as explained in the following section. WHAT YOU'VE HEARD SO FAR MAYBE DRAMATICALLY CHANGED BY MOVING JUST A FEW CONTROLS. This is demonstrated in the next section of the manual.*

- If you want to explore the "Keyboard & Plucked Group" voices that are stored in Bank B of this cartridge, slide the switch on the cartridge down to "B" position, and again press the voice selector buttons [1] to [32]. The same procedures apply to the "Orchestral & Percussive Group" voices in Bank A, and the "Complex & Effects Group" voices in Bank B of the DX7 VOICE ROM #2 cartridge.

### IMPORTANT NOTE

In order to provide meaningful examples as we explain the various buttons and functions on the DX7, we will refer to specific pre-programmed voices that are provided in the "MASTER GROUP", which is found in bank A of the DX7 VOICE ROM #3 cartridge that comes with the instrument. (These procedures are virtually the same for the internal voices, but since we don't know what particular voices are loaded in the instrument, we are using a known set of voices for now. Then our examples should match what your instrument actually does.) Some control functions have no effect unless the voice with which they are used is already programmed to be sensitive to the control.

To play the voice we are using in this portion of the manual as an example, you will need to set the DX7 to select the cartridge voice called "ELEC PIANO 1" (Electric Piano 1), which is in location A-8 of the DX7 VOICE ROM #3 cartridge. From the previous instructions we'll assume that cartridge is installed, the [MEMORY SELECT-CARTRIDGE] button has already been pressed and the top line of the LCD display already indicates "CARTRIDGE VOICE" (if not, do so now). Therefore you should only have to press the [8] button.

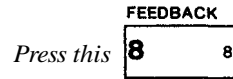

The display will change to show the voice

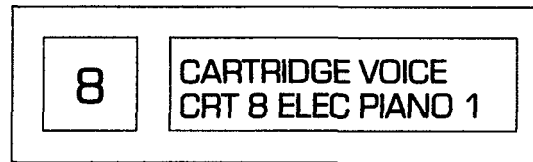

*NOTE There is no "right way" or "wrong way" to approach programming of the DX7, although some methods may be rather inefficient. This chapter is provided to familiarize you with the use of some of the programming functions. If something isn't perfectly clear to you at first, don't spend too much time on it; it will eventually make sense as you play the instrument and become familiar with its basic features and functions. We suggest you re-read these instructions after you've gained a certain degree of confidence with the DX7.*

### [DATA ENTRY]

A slider and two buttons at the left side of the control panel are marked [DATA ENTRY]. This group of controls is used for adjusting the settings of almost all the programmable levels and modes. Moving the slider down and up may turn one item OFF and ON, set another for a level of from 0 to 7, and set still another for a level or rate of from 0 to 99, and so on. For now, just remember that [DATA ENTRY] is an assignable group of controls that you use to change whatever you have selected with other controls on the DX7.

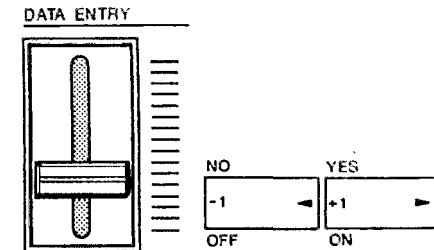

Whatever EDIT mode or FUNCTION mode programming parameter value happens to be displayed may suddenly "jump" to a different value as soon as the [DATA ENTRY] slide control is operated, or it may change gradually, depending on the specific value and the position of the slider. Think of the slider as having a scale (from bottom to top) of 0-3, 0-7, 0-12, 0-99 or OFF-ON, depending on the function. If the slider is positioned at a different point on its relative scale than the value displayed in the LCD window, then as soon as the slider is moved at all, the displayed value will jump to the slider-position value. In most cases, the two buttons next to the slider will increment or decrement the displayed value by 1 unit, with no "jump." The last selected FUNCTION parameter can be adjusted while in the PLAY mode.

### [FUNCTION]

There are 3 main modes of operation: PLAY mode, EDIT mode and FUNCTION mode. The parameters which can be adjusted in FUNCTION mode are those that affect the overall sound, no matter which voice you select (provided, in some cases, that the voice itself is programmed to accept the function control). This includes such parameters as the tuning of the keyboard, whether or not the portamento is active and how it works, and the effects of the modulation wheel, foot control, breath control, and the pressure sensitivity of

the keys (After Touch). Velocity sensitivity is NOT set in this mode; it is programmed into individual voices.

ALL THE PERFORMANCE PARAMETERS AFFECTED BY FUNCTION MODE ARE MARKED IN BROWN on the control panel. The Edit Recall and Voice Initialize functions are also marked in brown, as are the Cartridge Store/Load and Battery Check functions; even though these items do not affect the sound of all the voices, they are accessible from FUNCTION mode.

1. In order to examine and/or change the various performance parameters, you first have to press the brown [FUNCTION] button.

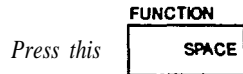

And you will see this

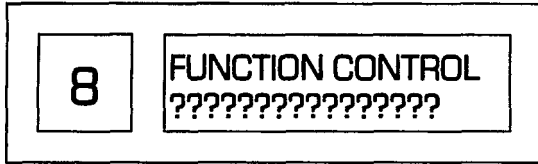

(The message on the second line of the display could be one of many. It doesn't matter now.)

The red LED display will continue to indicate the selected voice number (#8), and you can still play that voice, but the LCD display will change to indicate that the FUNCTION mode has been selected. As with voice selection, the particular FUNCTION that appears in the LCD display will be the last one selected, so we don't know exactly what that is.

2. Press the [MASTER TUNE] button. This sets the [DATA ENTRY] slider so it can adjust the overall pitch of the keyboard.

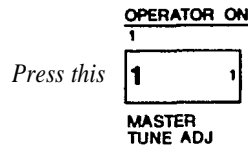

The display will now look like this

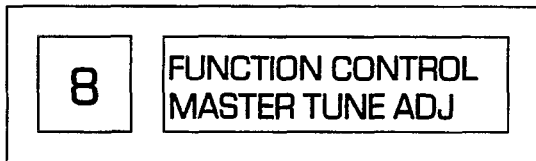

3. While playing a note or chord, move the [DATA ENTRY] slider up and down. The pitch will move with the slider because you have selected MASTER TUNE mode.

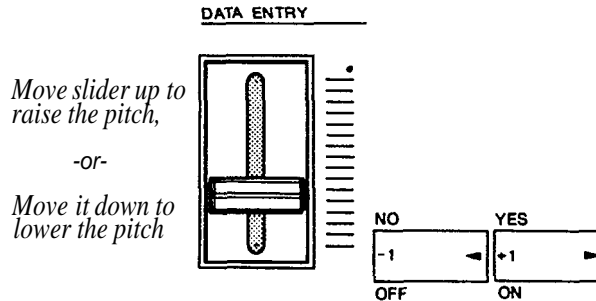

Move slider up to raise the pitch,

-or-

Move it down to lower the pitch

4. The two buttons next to the (DATA ENTRY) slider normally serve as "fine" adjustments to do the same thing the slider does as a "coarse" adjustment. In this particular case, however, the slider by itself is enough to tune the instrument since it is already programmed to have fine resolution in MASTER TUNE mode. Tune the DX7 to A = 440 Hz (slider approximately centered).

*NOTE: This function is primarily for tuning the synthesizer to other instruments. By limiting the adjustment to a narrow range ( $\pm 75$  cents), we make it easier to tune precisely with the slider. However, since each voice can, itself, be programmed to a unique pitch... or can be easily transposed (as explained elsewhere), there is really no limit to the actual pitch you can create when you press a given key*

**POLY/MONO**

The DX7 is a polyphonic instrument capable of playing 16 notes simultaneously. This means that while you are playing additional notes, up to 16 of them can sustain at one time. As soon as all 16 notes have been played, the DX7 will drop the first of the 16 notes when the next one is played. Sometimes, however, you may wish to have the instrument act as a monophonic (single note) synthesizer... for example, when you're playing a lead line. When FUNCTION mode is selected, pressing the [MONO/POLY] button sets the DATA ENTRY controls so you can make the choice.

1. Press the [POLY/MONO] button. This sets the [DATA ENTRY] slider and buttons so they can toggle back

and forth between polyphonic and monophonic modes.

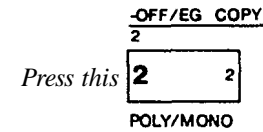

The display will now look like this

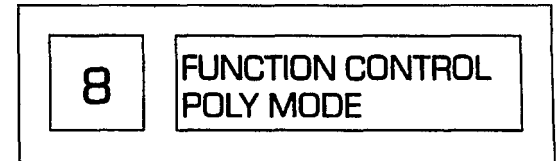

unless MONO mode had last been selected in which case the bottom line will indicate "MONO MODE".

2. If it is not already in MONO mode, set the instrument to that mode by pressing the [>] button (or by pushing the slider to the top) and see how the keyboard reacts. Observe that if you hold down one key then hit a higher or lower note, you will hear the most recent key you press. Thereafter, the keyboard is set correspondingly to high or low note priority until you release all keys. There is no "fixed" low or high note priority.

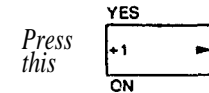

And see this

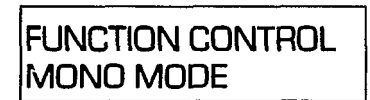

3. Experiment with moving the [DATA ENTRY] slider up and down. Notice the display toggle between "MONO MODE" (slider up) and "POLY MODE" (slider down). Now try pressing the adjacent [<] and [>] buttons. Notice they do the same thing as moving the slider down (<) and up (>). This relationship is true for most programming functions.
4. Set the instrument to POLY mode by pressing the [<] button or by pulling the slider to the bottom. See how the keyboard reacts. Observe that you can play chords, and if you hold one key pressing another

does not cancel the original note. Leave the instrument set to POLY mode for the time being.

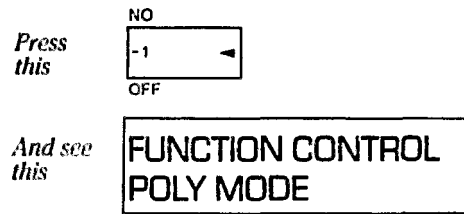

**PITCH BEND RANGE & STEP**

The PITCH bend wheel located at the far left side of the keyboard can be used to "bend" notes or chords, provided the Pitch Bend Range is set to some non-zero value. The wheel is spring-loaded to return to center from either direction.

The maximum pitch bend range is adjustable from 0 (no pitch bend) to a as much as 12 semitones in either direction (plus or minus an octave). Additionally the PITCH wheel can be programmed for a smooth, continuous bend, or the change can occur in "steps" of a size you set (from 0 to 12 semitones). The *RANGE adjustment works only when the step size is set to 0; when discrete steps are selected, the maximum range is 1 octave, with the step size determining the highest and lowest pitch actually available.*

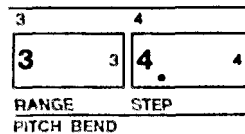

1. Press the [PITCH BEND-STEP] button first. This sets the [DATA ENTRY] slider and buttons so they can adjust the size of the steps that will be produced when you operate the PITCH bend wheel. Try it — move the [DATA ENTRY] slider (or press the adjacent [

Since the RANGE function works only when the step size is zero (continuous glide), move the [DATA ENTRY] slider, or instead press the adjacent [-1] button as many times as may be necessary to obtain a step size of zero.

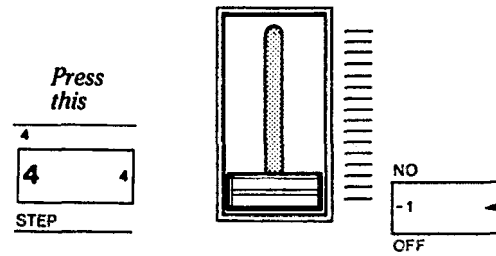

When the DX7 is set for a pitch bend step size of zero, the display should look like this:

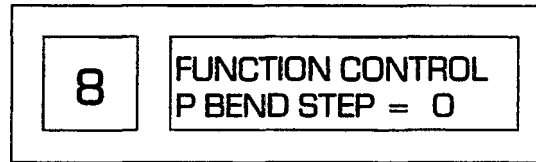

2. Press the [PITCH BEND-RANGE] button and move the [DATA ENTRY] slider up and down to get different range values displayed in the window. Play a note or chord and use the PITCH wheel to try each setting. When you've experimented, leave the system set for a maximum 12 semitone pitch bend range. (As soon as you select a [STEP] size other than zero, the [RANGE] is automatically reset to 12 semitones.)

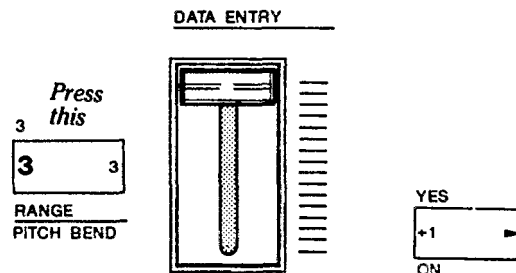

When the DX7 is set for a pitch bend range of plus or minus an octave, the display should look like this:

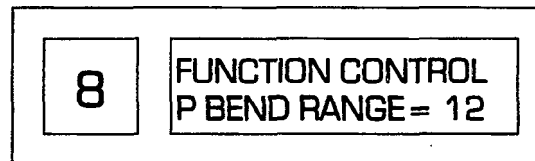

3. Notice that if you hold a key and hold the PITCH wheel at a given position, moving the [DATA ENTRY] slider will not have an effect. You have to release the wheel first and then play to hear the effect of the new pitch bend range setting. (This "set-then-test" rather than "set-while-testing" function characterizes many of the DX7 programming controls.)
4. Go back and experiment with different step sizes by pressing [PITCH BEND-STEP] and moving the slider and/or pressing the [+1] and [-1] buttons. The bend was continuous with the step size at 0. A step size of 1 enables you to hear each semitone as you move the wheel, and, at the other extreme, a step size of 12 means you'll hear the note or chord "jump" a full octave.

Any step size above 0 sets the range to 12, but specific step sizes affects the maximum available range; it may not always be as much as plus or minus an octave. For example, if you choose a step size of 5 steps, and move the PITCH wheel slightly you'll get a jump up or down of 5 semitones. Full deflection of the wheel from its resting position will cause the pitch to jump up or down a total of 10 semitones... and that's it. A range of 6 steps, however, would allow for an octave of pitch "bend" in 2 increments.

**PORTAMENTO FUNCTIONS**

*NOTES*

Several related functions are grouped under the FUNCTION heading "PORTAMENTO." The actual effects obtained will depend upon more than the PORTAMENTO settings.

What you hear will change when the synthesizer is set to POLY or MONO mode. We initially explore the PORTAMENTO and GLISSANDO effects in POLY mode since that is the mode to which we have already set the DX7.

Specific effects also change based on the inherent sustain programmed into a given voice, and whether or not you use the SUSTAIN foot pedal. We recommend that you have the FC-4 or FC-5 foot switch plugged into the rear panel SUSTAIN jack in order to fully benefit from these instructions. If a footswitch is not plugged into the PORTAMENTO jack, then the portamento will be ON.

## PORTAMENTO & GLISSANDO IN POLY MODE

### Sustain: Key Pitch Retain

1. Press [PORTAMENTO TIME] and use the [DATA ENTRY] controls to set a time of 80, as indicated in the LCD window. (If the TIME is set at or near zero, there will be no discernable portamento or glissando effect, regardless of what you do with the other PORTAMENTO functions. Higher values than 80 are OK, but will take more of your time than necessary when exploring these functions.)

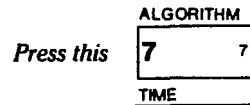

DATA ENTRY

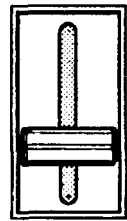

Then adjust this slider or the adjacent buttons

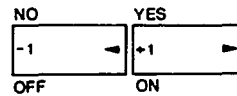

Until the display looks like this

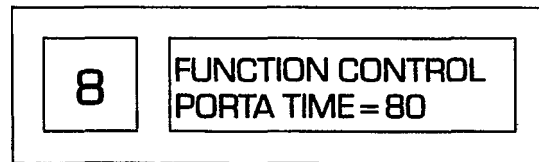

2. Now press [GLISSANDO] to see whether the Glissando is turned on or not; the display will indicate one of two modes, "GLISSANDO=ON" or "GLISSANDO=OFF." For now let's make sure it off, which means the DX7 is in PORTAMENTO rather than GLISSANDO mode.

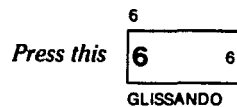

DATA ENTRY



Then, if necessary, move the slider down or press this button so the display indicates "GLISSANDO=OFF"

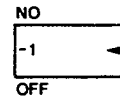

The display should look like this

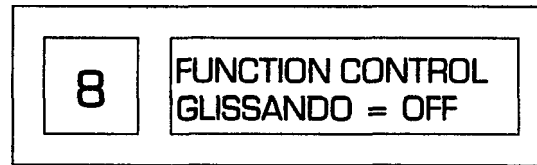

3. Now press [PORTAMENTO-MODE] to see which of two possible modes is engaged; the display will indicate either "SUS-KEY P FOLLOW" or "SUS-KEY P RETAIN." Lets make sure it is set to "SUS-KEY P RETAIN."

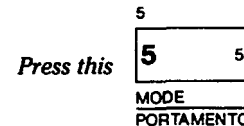

DATA ENTRY

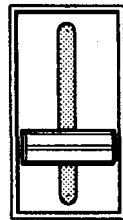

Then, if necessary, move the slider down or press this button so the display indicates "SUS-KEY P RETAIN"

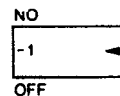

The display should look like this

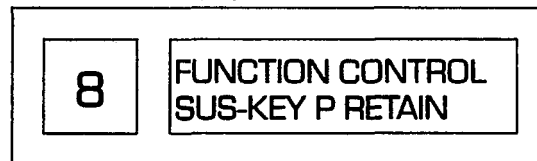

4. Now play several notes, one after the other, while stepping on the SUSTAIN pedal. Play a bass chord, then a high note. Observe that the pitch glides from the previously played note(s) to the next note(s), but the sustain of the earlier notes remains at their original pitch. Experiment with this effect.

### Sustain: Key Pitch Follow

Assuming you have just completed the previous instructions, the DX7 is in "SUSTAIN: KEY PITCH RETAIN" mode, with SUSTAIN mode engaged (i.e., GLISSANDO turned off), and a moderate PORTAMENTO time of 80. Now let's explore "SUSTAIN: KEY PITCH FOLLOW" mode.

1. Since the DX7 is already in PORTAMENTO mode, press the [>] DATA ENTRY button or push up the slider to set the DX7 to SUSTAIN-KEY PITCH FOLLOW mode.

DATA ENTRY

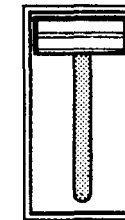

Push up the slider or press this button so the display indicates "SUS-KEY P FOLLOW"

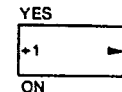

The display should look like this

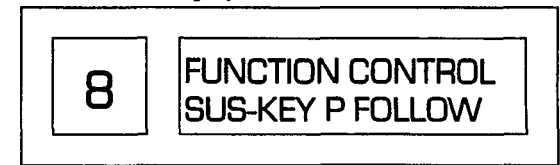

2. Now play several widely spaced notes or chords, one after the other, while stepping on the SUSTAIN pedal. Observe that the pitch again glides from the previously played note(s) to the next note(s), but the sustain of the earlier notes also moves up to the latest note or chord played (FOLLOWS) instead of RETAINING the original pitch.

**Glissando (Key Pitch Retain & Key Pitch Follow)**

Glissando is similar to the Portamento effects you just explored, with this exception; the pitch glide in Portamento is continuous, whereas in Glissando it moves up or down in 1/2 step increments. Glissando works with either the "Follow" or "Retain" functions.

1. Press [PORTAMENTO/GLISSANDO], and then press the DATA ENTRY [ON] button to place the instrument in glissando mode.

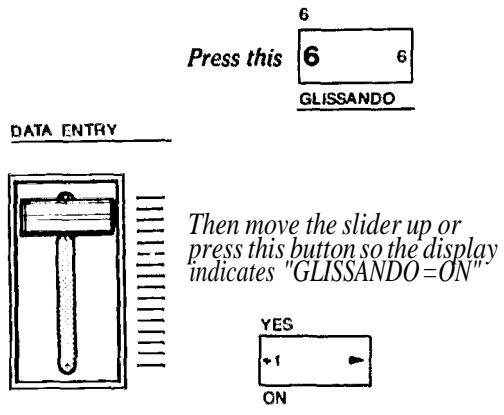

The display should look like this

**FUNCTION CONTROL  
GLISSANDO = ON**

2. Again play several widely spaced notes or chords while stepping on the SUSTAIN pedal. Observe how the pitch moves to the most recent note(s) in 1/2 step increments. The speed can be changed by pressing [PORTAMENTO-TIME] and adjusting [DATA ENTRY].
3. The instrument is still in "FOLLOW" mode, so the glissando effect cancels the sustain of previous notes. Now try the effect in "RETAIN" mode by pressing [PORTAMENTO-MODE] and the DATA ENTRY [<] button.

**PORTAMENTO & GLISSANDO IN MONO MODE**

When the DX7 is placed in MONO mode rather than POLY mode, the available portamento/glissando effects change somewhat. When you press [PORTAMENTO

MODE], you no longer have a choice of "RETAIN" or "FOLLOW" functions; instead, you can choose between "FINGERED PORTA" and "FULL TIME PORTA" (where "PORTA" refers to portamento or glissando); These differences are explained below.

**Fingered Portamento (and Glissando)**

1. It is OK to leave the Portamento Time at 80, but for now, let's turn off glissando by pressing [GLISSANDO] and then the DATA ENTRY [OFF] button.
2. Set the DX7 to MONO mode by pressing [POLY/MONO] and then the DATA ENTRY [>] button.

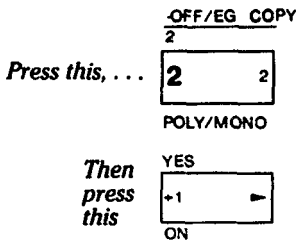

And see this

**FUNCTION CONTROL  
MONO MODE**

3. Select the Fingered Portamento mode by pressing [PORTAMENTO-MODE] and then the DATA ENTRY [<] button.

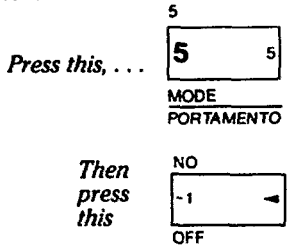

And see this

**FUNCTION CONTROL  
FINGERED PORTA**

4. Observe that if you hold down one key, then press a second key that is a higher or lower note, you will hear the pitch from the original note move to the new pitch. If you then release the first key the pitch stays

at the new one, whereas if you continue holding the first key and release the second key, the pitch glides back to the original.

5. Now play several notes in succession, releasing one before playing the next. Notice that there is no portamento. *THIS EXPLAINS "FINGERED PORTA" MODE: you only get portamento when one key is pressed while another is still being held down.*
6. You can obtain a "Fingered Glissando" effect in much the same way (with stepped pitch shift instead of a continuous glide); just press (GLISSANDO) and then the DATA ENTRY [ON] button.

**Full Time Portamento (and Glissando)**

1. It is OK to leave the [PORTAMENTO TIME] at 80, although interesting effects can be obtained at lower values, too. Leave the keyboard in MONO mode, with glissando turned off.
2. Select the full time portamento mode by pressing [PORTAMENTO-MODE] and then the DATA ENTRY [>] button.

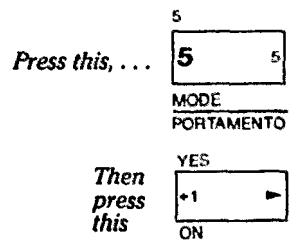

And see this

**FUNCTION CONTROL  
FULL TIME PORTA**

3. The portamento will work the same as in FINGERED PORTA mode if you hold a key and then press a second key. However, if you now play several notes in succession, releasing one before playing the next, you'll find the portamento remains active. *THIS EXPLAINS "FULL TIME PORTA" MODE; you always get portamento, even if one key is released before the next one is pressed down.*

*NOTE If a foot switch is plugged into the Portamento jack, it will have no effect in the FINGERED PORTA mode. In FULL TIME PORTA mode, the foot switch can be used to turn the effect on and off.*



4. You can obtain a "Full Time Glissando" effect in much the same way (with stepped pitch shift instead of a continuous glide); just press [GLISSANDO] and then the DATA ENTRY [ON] button.
5. Enough work — take a fun break! Now that you've been exposed to some of the FUNCTION control features, try using them with other voices. You can select any voice by pressing either [MEMORY SELECT-INTERNAL] or [MEMORY SELECT-CARTRIDGE] and then any voice selector button from 1 to 32. Once you've selected a voice, press [FUNCTION] to experiment with the Master Tuning, Poly/Mono, Pitch Bend and Portamento functions. When you've finished experimenting, select the "E. PIANO 1" voice again.

*NOTE The following modes should be reset as indicated so that the rest of the instructions in this section can be accomplished without confusion from any portamento, glissando, or pitch bend effects. Press [FUNCTION], then:*

- Return to polyphonic mode by pressing [POLY/MONO] and then [ $\leftarrow$ ].
- Turn off glissando mode, if engaged, by pressing [GLISSANDO] and [OFF].
- Set the portamento time to zero by pressing [PORTAMENTO TIME] and pulling the [DATA ENTRY] slider down so the display indicates "PORTATIME=0".
- It doesn't make any difference which portamento mode is set since, with the time at zero, there is no effect.

## MIDI

MIDI is an acronym for Musical Instrument Digital Interface. The MIDI connectors on the back of the DX7 permit 16 channels of digital information to be shared with other synthesizers, sequencers, and computer controllers. MIDI permits two or more synthesizers to be played from one keyboard, as well as remote-controlled voice selection and even remote-controlled voicing within the DX series. Voice selector button [8], the [MIDI] button, actually selects multiple functions in the FUNCTION mode when it is pressed successive times. When the display shows "MIDI CH ?" you use the [ $\leftarrow$ ] and [ $\rightarrow$ ] to select any of the 16 MIDI channels for receiving information: only Channel 1 is needed to remotely program or play multiple synthesizers (the other channels are reserved for sequencers, computer interface and as yet undetermined future uses). Pressing the [MIDI]

button again shows either "SYS INFO AVAIL" or "SYS INFO UNAVAIL", depending on how you press the [YES] and [NO] buttons.

"SYS INFO AVAIL" enables you to program other devices connected by MIDI cable — to send every parameter for one voice or all 32 internal voices from the Master to the Slave, and you can also select and play voices on the Slave(s). To send all 32 voices to another DX7 (or 20 of them to a DX9), once "SYS INFO AVAIL" is displayed, press the MIDI button [8] again and, when the display asks "MIDI TRANSIT?" press the [YES] button (memory protect must be OFF in the other synthesizer). Individual voices or parts of voices can also be transferred. If you set the instrument so it displays "SYS INFO UNAVAIL," then you can change programs (select different voices) and play the Slave from the Master, but you cannot transfer voice parameters from one instrument to the other.

FEEDBACK



## EDIT RECALL

This function is used as an "emergency backup" to recall a voice that was "lost" while it was being edited or created from scratch. Please do not press this button right now; if you already have, just press [NO] or another FUNCTION button, like [BATT CHECK]. This button's operation is described in the "FUNCTION Mode" portion of the "Quick Basic Features" section of this manual. See page 9.

LFO  
WAVE



EDIT RECALL

## VOICE INT (Initialize)

This function is used to create a new voice "from scratch," and pressing it is the first step of an alternative method of entering the EDIT mode. Please do not press this button right now; if you already have, the display shows "VOICE INIT?"; press [NO] or any other FUNCTION button to cancel the mode. This button's operation is described in the "FUNCTION mode" portion of the "Quick Basic Features" section of this manual. See page 9.

SPEED

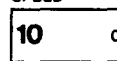

VOICE INIT

## CARTRIDGE FORMAT

Voice selector button [11] serves a special purpose in the FUNCTION mode. Pressing this button selects the cartridge FORM (format) function. *Formatting erases all the voices in a RAM cartridge.* Don't experiment with this feature unless you're willing to lose the voices on the RAM. Instead, read the description in the "FUNCTION mode" portion of the "Quick Basic Features" section of this manual. See page 9.

DELAY

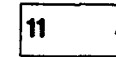

## BATTERY CHECK

The battery backup preserves the internal RAM voice memories when the AC power is turned off. The normal battery voltage ranges from 2.3 to 3.5 volts. If the battery voltage is too low, the synthesizer will operate normally but any voices in the internal memories may be lost or altered when power is turned off. Therefore, it is advisable to check the battery voltage prior to turning off the instrument and, if it is low, be sure the internal voices are saved on a cartridge. (Refer to page 49 for instructions on storing your voices in the RAM cartridges.)

Press the [BATTERY CHECK] button and examine the voltage. If it is below 2.2 volts, the battery must be replaced; if it is over 3.6 volts, something may be wrong with the DX7.

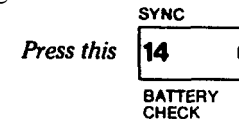

And see this

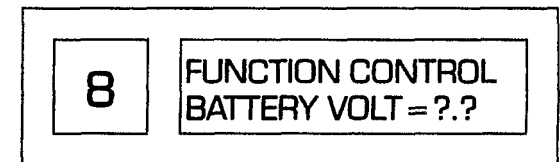

The voltage should be between 2.3 and 3.5

**CAUTION** The battery is a long-life Lithium type, and when it is exhausted (below 2.2 volts) it must be replaced by your Yamaha dealer. Be sure you save any internal voice on

*a RAM cartridge before submitting the instrument for a new battery or repair. See page 49 for Cartridge Save and Load descriptions and directions. Please do not try to change the battery yourself; expensive damage that is not covered by your Warranty may result.*

**MODULATION WHEEL  
FOOT CONTROL  
BREATH CONTROL  
AFTER TOUCH**

OSCILLATOR			
MODL/ SYNC	FREQUENCY COARSE	FREQUENCY FINE	DETUNE
17 G	18 H	19 I	20 J
RANGE	PITCH	AMPLITUDE	EG BIAS
MODULATION WHEEL			

EG		KEYBOARD LEVEL SCALING	
RATE	LEVEL	BREAK POINT	CURVE
21 K	22 L	23 M	24 N
RANGE	PITCH	AMPLITUDE	EG BIAS
FOOT CONTROL			

KEYBOARD RATE SCALING		OPERATOR	
DEPTH	KEYBOARD RATE SCALING	OUTPUT LEVEL	KEY VELOCITY SENSITIVITY
25 O	26 P	27 Q	28 R
RANGE	PITCH	AMPLITUDE	EG BIAS
BREATH CONTROL			

PITCH F.G.		KEY TRANSPOSE		VOICE NAME	
RATE	LEVEL	KEY TRANSPOSE	VOICE NAME	RANGE	PITCH
29 S	30 T	31 U	32 V		
AFTER TOUCH		AMPLITUDE	EG BIAS		

When we arrange these four groups of FUNCTION controls above one another on this page (for the Modulation Wheel, Foot Control, Breath Control and After Touch), you can see the groups are essentially identical.

There are three main components of a voice to which LFO modulation can be applied: to the PITCH, to the AMPLITUDE, or to the EG (envelope generator) BIAS.

(Actually each operator or "sub-component" of a voice may or may not be internally programmed to be sensitive to these modulation sources.) The fourth button, RANGE, lets you set the maximum amount of modulation that can be applied to each of the adjacent three voice components.

The only difference between the four groups of four FUNCTION controls is the means you use to control the LFO modulation. It can be introduced:

- A) when you move the modulation wheel at the left of the keyboard,
- B) when you tilt an FC-3A foot controller plugged into the MODULATION jack,
- C) when you blow into the BC-1 breath controller plugged into the BREATH CONT jack, or
- D) when you press hard on a key (or keys) to activate the after touch sensors within the keyboard.

Because the four groups of modulation controls all operate similarly we will concentrate primarily on just one modulation source: the MODULATION WHEEL.

**First, make sure all modulation is OFF**

*NOTE While you may not be using a given source of modulation, it can still affect the voice if its FUNCTION control parameters are inappropriately set. SOME SETTINGS COULD RESULT IN LITTLE OR NO AUDIBLE OUTPUT FROM THE SYNTHESIZER.*

*Therefore, to simplify the operation as we go through the following explanations, we first instruct you to turn off all the modulation sources except the MODULATION WHEEL. Later when you actually play the instrument, you can turn on the modulation as you wish.*

1. If the instrument is not still in FUNCTION mode (upper line of the LCD display showing "FUNCTION CONTROL"), press the [FUNCTION] button. Then press [MODULATION WHEEL-PITCH] and see whether the modulation is on.

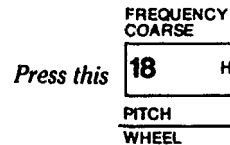

(The ??? will either be "OFF" or "ON")

2. For now, the object is to turn off all modulation. Therefore, if the display shows "WHEEL PITCH=ON", use [DATA ENTRY] to turn it off.

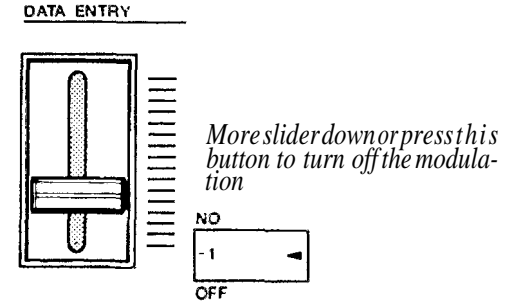

And see this



3. Repeat steps 1 and 2 above, but instead of pressing [MODULATION WHEEL PITCH], press [MODULATION WHEEL-AMPLITUDE] and then [MODULATION WHEEL-EG BIAS]. In each instance, use [DATA ENTRY] as required to turn OFF the modulation.

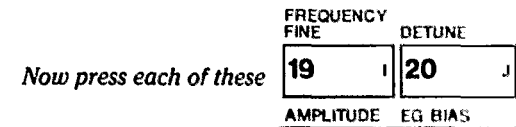

And press this if necessary to ensure all the modulation sources are turned off

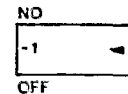

4. Now repeat steps 1 through 3 above for the Pitch, Amplitude and EG Bias functions of the FOOT CONTROL, BREATH CONTROL, and AFTER TOUCH groups; in each case, make sure the LCD display indicates the function is OFF or else use (DATA ENTRY) to turn it off.

*NOTE It is not necessary to press the [RANGE] buttons to set the range for any of these modulation sources because the range has no effect when the modulation is turned off.*

5. Play the keyboard and then move the MODULATION WHEEL toward "MAX". Notice it does not change the sound; that's because you just turned OFF the Wheel's effect.

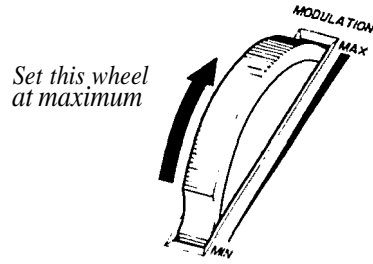

*NOTE You will now be asked to turn on the MODULATION WHEEL effects and see how they can be used to alter the sound of different voices.*

**Selectively turn ON and try the modulation**

1. Press [MODULATION WHEEL-PITCH] and then press the DATA ENTRY [ON] button to activate the pitch modulation effect.

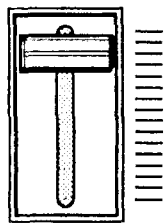

*Then move slider up or press this button to turn on the modulation*

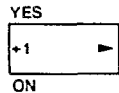

*And see this*



2. Play the keyboard and operate the MODULATION WHEEL.

AT THIS POINT YOU MAY OR MAY NOT HEAR THE PITCH CHANGE IN A VIBRATO-LIKE FASHION. THERE REMAIN SEVERAL VARIABLES WHICH WE HAVE NOT YET DISCUSSED. The amount of pitch

modulation achieved with the wheel will depend not only on the setting of the wheel itself, but also on the set Range, and on the Pitch Modulation Sensitivity of individual voices.

3. Set the MODULATION Wheel at maximum (notch in the wheel toward the back of the instrument). Then press [MODULATION WHEEL-RANGE] and use the [DATA ENTRY] slider to set different values from 0 (no modulation) to 99 (maximum modulation) while playing the keyboard. IF YOU DON'T HEAR THE MODULATION, BE SURE YOU'RE HOLDING DOWN THE KEYS FOR AT LEAST A FEW SECONDS.

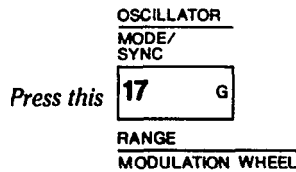

*And set this wheel to take advantage of the maximum set modulation*

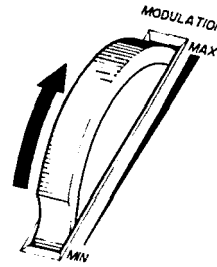

*Then move this slider up to achieve the maximum possible range of modulation*

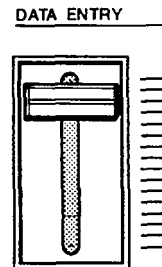

*And see this*



**IMPORTANT NOTE** At this point it is still possible that you won't hear any pitch modulation, even when the wheel is at maximum and the [MODULATION WHEEL-RANGE] is set to 99. This is because the voice itself must first have been programmed to be sensitive to pitch modulation.

4. If you don't hear pitch modulation with the "WHEEL PITCH = ON", the Wheel at MAX, and the "WHEEL RANGE = 99", leave these controls set, and *try other voices*. Other voices may be programmed to be sensitive to pitch modulation.

From this point, you can access other voices by pressing [MEMORY SELECT-INTERNAL] or [MEMORY SELECT-CARTRIDGE]. Then press each voice selector button, [1] through [32], and move the MODULATION WHEEL back and forth to test these voices. When you find a voice that sounds interesting with the pitch modulation, again press the [FUNCTION] button and try moving the [DATA ENTRY] slider to change the modulation RANGE so you can hear how the wheel works at other than maximum available range.

5. Now that you've explored the Modulation Wheel PITCH modulation, try applying AMPLITUDE modulation.

To work without confusing two types of modulation, you'll want to turn ON only one effect at a time. Therefore first turn OFF Pitch modulation by pressing [MODULATION WHEEL-PITCH] and then DATA ENTRY [OFF]. Then turn ON Amplitude modulation by pressing [MODULATION WHEEL-AMPLITUDE] and DATA ENTRY [ON].

*NOTE Applying AMPLITUDE modulation makes individual operators (voice sub-components) louder and softer, which can affect the volume or the tone or both, depending on the particular voice's internal structure. Once again, the voice must be programmed to be sensitive to the type of modulation. The voice we have been using as an example, "E.PIANO 1" is sensitive to pitch modulation, but not to amplitude modulation, so the wheel will not have any effect on the voice with only amplitude modulation turned on. Try the other voices to find one which is sensitive to amplitude modulation; a saxophone voice would be a likely choice.*

6. In a similar fashion to step 5 above, turn OFF the [MODULATION WHEEL-AMPLITUDE] and turn ON the [MODULATION WHEEL- EG BIAS]. The EG bias does not utilize LFO modulation, but instead it varies the amplitude of any envelopes whose Modulation Sensitivity is programmed to a value greater than zero. As a result, you can use the MODULATION Wheel (or any modulation controller such as the

# HOW THE DX7 CREATES SOUNDS

Breath Controller or Foot Controller) to turn notes up and down within the existing envelopes, provided you are also playing the notes on the keyboard. The more EG bias, the less amplitude is present when you play a note; the level increases when you add EG bias by advancing the Wheel.

- When you've experimented with [MODULATION WHEEL-EG BIAS], turn it OFF, and try each of the 3 types of modulation with the other sources (Foot Control, Breath control and After Touch). Each of the above sources of modulation can be programmed to function differently, so this is not necessarily a redundant system. For example, you might use the after touch to add pitch modulation, the modulation wheel to add amplitude modulation, and the breath controller to alter EG bias (blowing notes, provided you first hold down the key(s) for a given voice.
- After you've explored all the modulation functions, we recommend that you go through them and set them in a way that will be useful as you work through other sections of this manual. Therefore, please set the modulation as follows:

CONTROLLER	FUNCTION			
	RANGE	PITCH	AMPLITUDE	EG BIAS
MODULATION WHEEL	50	ON	OFF	OFF
FOOT CONTROL	51)	ON	OFF	OFF
BREATH CONTROL	50	ON	OFF	OFF
AFTER TOUCH	50	ON	OFF	OFF

*(These settings are not ideal for all voices. If, for instance, you're playing the voice called "SAX - BCI", you will want to turn ON the Breath Controller EG bias, and perhaps set Us range to 99.)*

## Operators

The Yamaha DX Series FM digital synthesizers use pure tones (sine waves) that interact to create all the overtones needed for any voice. Each sine wave oscillator has its own envelope generator. The combination of the two is called an "operator."

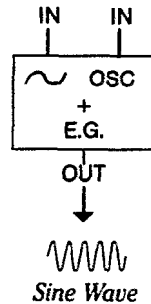

*The primary functional circuit in the DX7 is comprised of the digital SINE WAVE OSCILLATOR plus a digital ENVELOPE GENERATOR with multiple inputs and just one output. This is called an OPERATOR.*

If you could look inside an operator (which is just a digital circuit), you might see a block structure that looks like this:

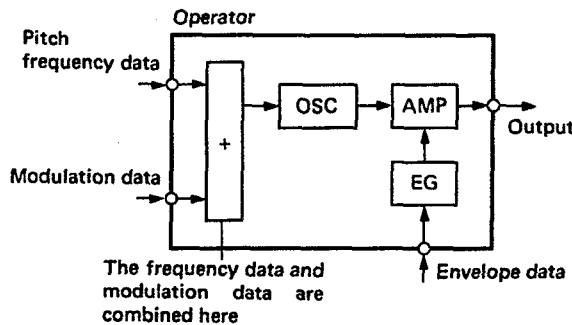

## Carriers, Modulators and FM

The DX7 has 6 operators. When the output of one operator is connected to the input of another, modulation occurs. Harmonics are generated — up to a whole spectrum of frequencies that are the equivalent of a triangle wave or a sawtooth or a square wave, etc. — all from a pair of sine waves. Additionally, operator's sine wave outputs can be mixed together. The two processes, mixing and modulating (whereby the sine waves interact and produce complex sounds), are called FM synthesis.

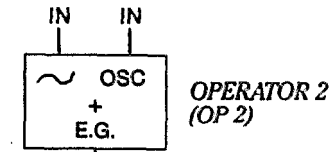

*This operator is the "Modulator" (see next page)*

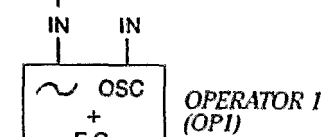

*This operator is the "Carrier" (see next page)*

to audio output

*When the output of one OPERATOR is "patched" to the input of another Operator, the result is a complex waveform. This is the essence of FM SYNTHESIS.*

## FM TONE GENERATION

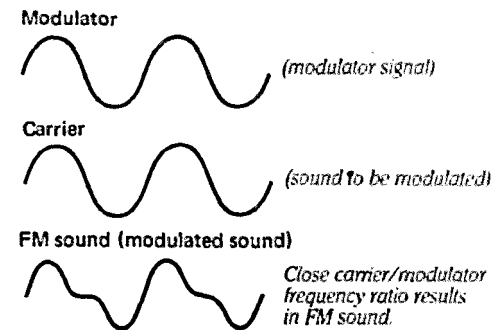

## Algorithms

Different arrangements of operators are known as "algorithms." An algorithm is something like a "patch" on a modular synthesizer; it defines the way the operators are interconnected, only instead of using patch cords, the DX synthesizers digitally switch the operators to make up the various algorithms. The DX7 lets you select among 32 different algorithms. Referring to the diagrams on the top panel of the synthesizer, the small boxes numbered 1-6 are the operators, and each "map" of operators (numbered 1-32) is an algorithm:

### ALGORITHM #1

Algorithm 1 has 2 carriers and 4 modulators

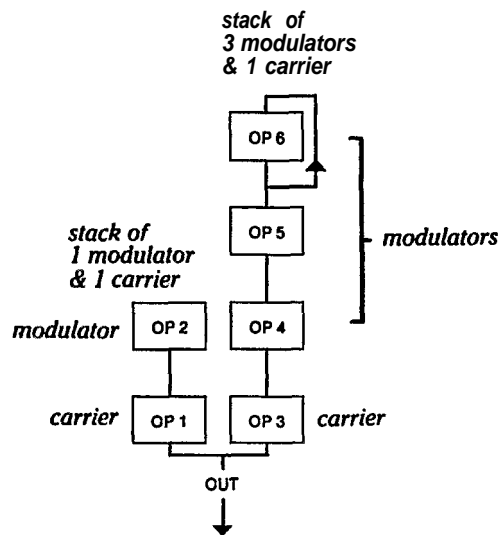

A given arrangement of OPERATORS is called an ALGORITHM. The available Algorithms are numbered. Illustrated here is Algorithm #1, which happens to have 2 parallel STACKS, one with 2 operators, and the other with 4 operators.

### The relationship between algorithms and the sound

By changing the relative frequencies of each operator, you can change not only the fundamental pitch of the note, but also the frequencies present in the note's harmonic structure. Thus, the timbre of the voice can be precisely controlled. In addition, because each operator has its own envelope, the harmonic structure of a note

can be programmed to change over time, just as a plucked string changes its overtones as the note decays.

Depending on the selected algorithm, operators can be stacked up vertically ("series connected"), arranged side by side ("parallel connected") or both. In the vertical arrangement, when the output of one operator is connected to the input of the next, the result is modulation — the essence of FM synthesis. By convention, we call the operator at the bottom of a vertical stack the "carrier", and any operators that are above and which feed its input are known as "modulators." By increasing the output level of the modulators (going into a given carrier, you increase the number of harmonics present, extending the bandwidth of the voice (making it more "brilliant").

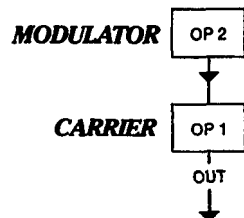

The bottom operator of a stack is called a CARRIER. Any operators which are connected to the carrier's inputs are called MODULATORS. YOU CANT HEAR A MODULATOR DIRECTLY, but you hear its effect by listening to the carrier's altered (modulated) output. A given operator can be either a carrier or a modulator: the only difference is how it is "connected" in a given algorithm.

Most algorithms have multiple carriers and modulators. In one algorithm a given operator may be a carrier, while in the next algorithm it may be a modulator — the only difference is how it is connected. In algorithm #5, for example, there are 3 vertical stacks connected in parallel, and each stack has a single modulator connected to a single carrier. Thus algorithm 5 has an equal number of carriers and modulators (3 of each). In contrast, all 6 operators in algorithm #32 are carriers... there are no modulators, while in algorithm #16 there are 5 modulators and just 1 carrier.

As you move from algorithm #32 to #1, there is a greater potential for increased harmonic complexity due to the structure of the algorithm. However, the algorithm alone does not determine the sound. The actual nature

of the sound you achieve is highly dependent upon the frequencies and levels you program into the operators (modulators and carriers). The 32 algorithms available in the DX7 were selected because they offer a broad spectrum of useful programming possibilities.

### ALGORITHM #5

Algorithm #5 has 3 carriers and 3 modulators

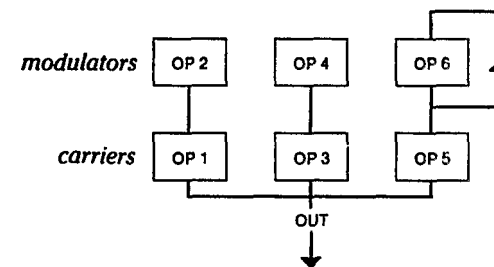

### ALGORITHM #16

Algorithm #16 has 1 carrier and 5 modulators

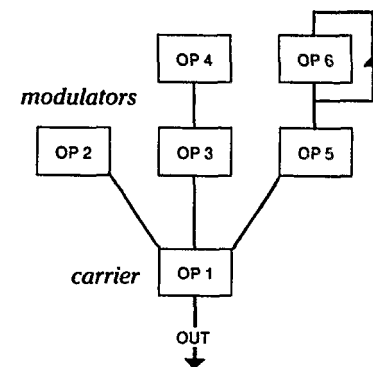

### ALGORITHM #32

Algorithm #32 has 6 carriers and no modulators

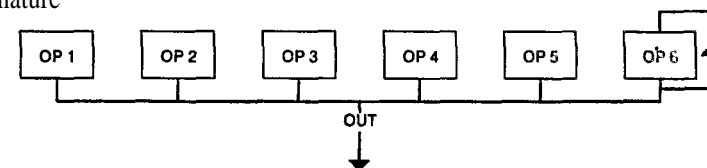

The results of using different frequency ratios, as well as different algorithms, are shown graphically in the accompanying illustration. In the left column, you see the resulting waveforms created by 1:1,2:1 and 3:1 frequency ratios when a modulator is stacked atop a carrier — for example, operators 1 and 2 in Algorithm 5 or 16. In the right column you see the resulting waveforms from these same 3 frequency ratios when the two operators are side-by-side, both serving as carriers so there is no frequency modulation, but instead there is additive synthesis.

Still more variations can be achieved by changing the

relative output levels between operators; the greater the level of the modulator, the more harmonics are present.

**Feedback is available in every algorithm**

Notice that every algorithm includes one FEEDBACK path. The feedback is usually "wrapped around" a single operator, with a few exceptions noted below. The feedback returns a portion of the operators output back to an additional input on the same operator (except in algorithms #4 & #6, where the feedback is returned to the top modulator on the "stack". In effect, the operator is modulating itself when feedback is used. While the

feedback paths are part of every algorithm, feedback is not used in every voice; an editing function permits the amount of feedback to be set to any of 8 values from none (0) to a maximum (7).

Often, the only difference between two algorithms is the location of the feedback loop. This is true with algorithms #3 and #4, and with algorithms #5 and #6, as illustrated. If you were to switch between either of the two algorithms in a pair with the feedback level at 0, there would be no difference in the sound, whereas with the feedback at a higher setting, the sound could differ significantly.

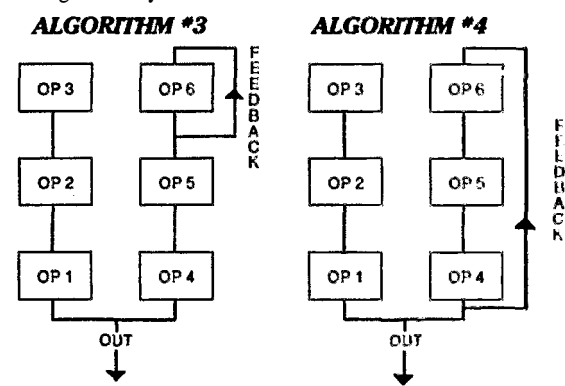
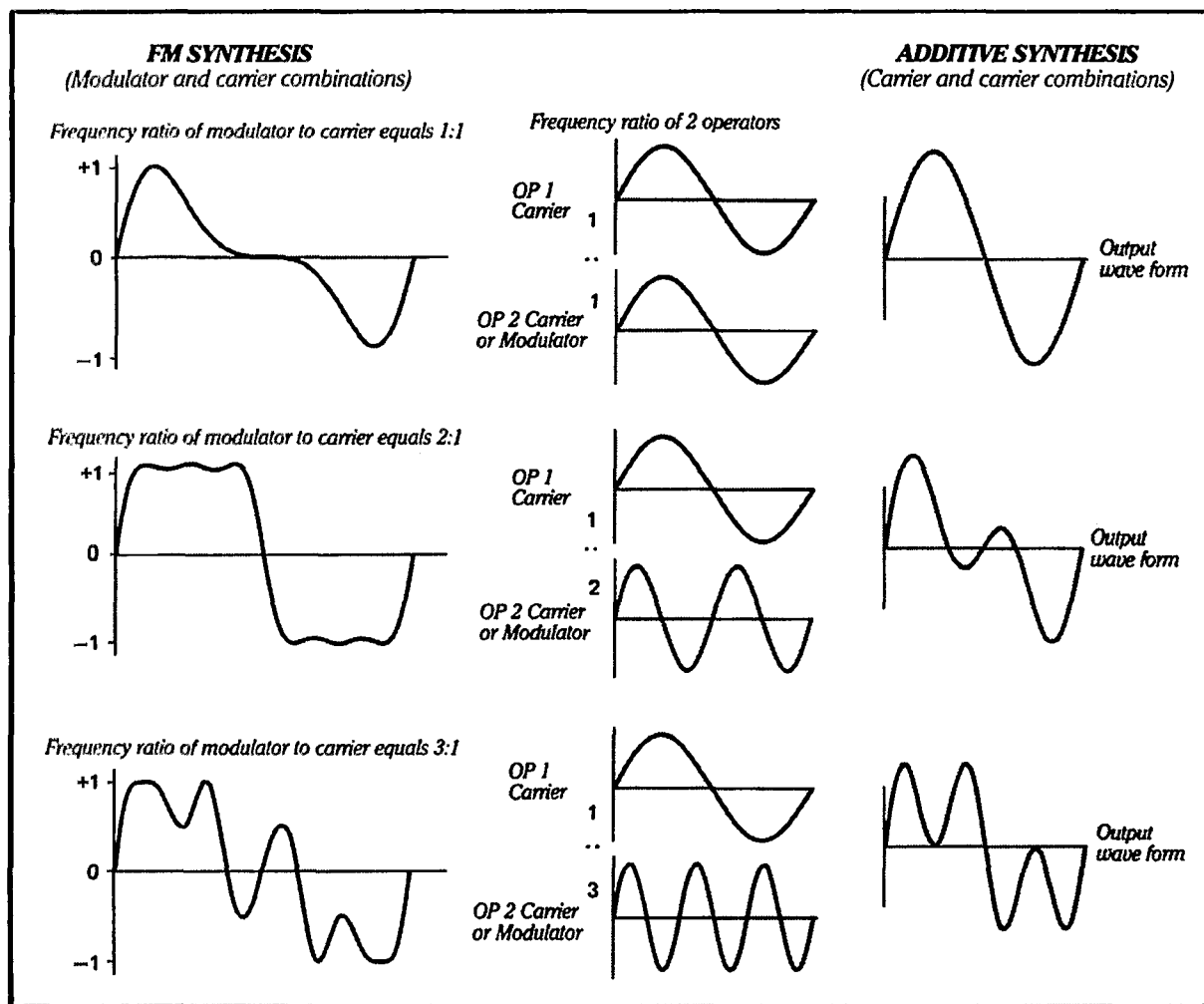

If FEEDBACK is at 0, these two algorithms become identical

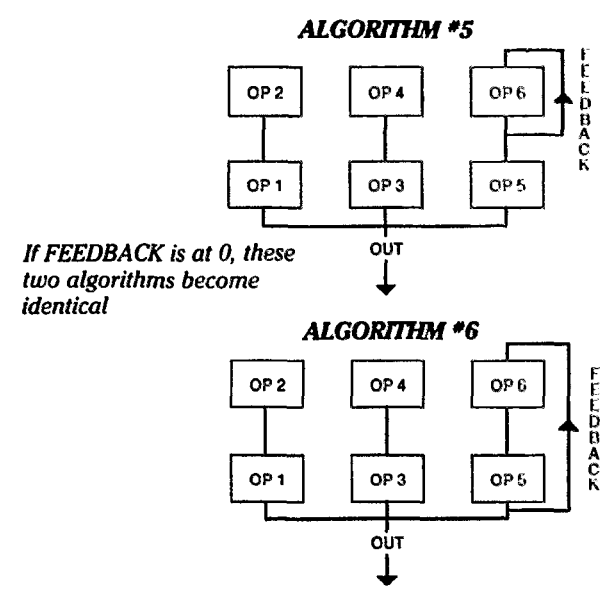

If FEEDBACK is at 0, these two algorithms become identical

## Envelopes and Envelope Generators

Consider what happens when you play a note. The volume goes up to some value, then eventually falls to nothing, with some sort of reasonably well defined pattern that is characteristic of the particular instrument. For example, a low note on a pipe organ starts slowly when you press a key due to the time the column of air takes to build up in the long pipe, and the note takes a while to die away as the column of air collapses in the pipe. In contrast, a note played on a wood block starts quickly as the mallet strikes the block, and dies quickly as the block stops resonating. The overall pattern of the volume when you play a note — how loud the note becomes at any instant, and how long it takes to change in level — is known as the "volume envelope." Organs and wood blocks have very different envelopes. With some unusual "synthesizer" voices, a note may not end at zero volume, so the next note won't start at zero volume. In some cases, notes can start at maximum, then go to zero when you press a key then come back to maximum level when you release the key; These are exceptions to the rule, and such notes still have envelopes, even if they are inverted.

Similarly, changes in timbre occur from the onset of a note to the time it dies away; these changes can also be defined by an envelope.

In the DX7, each of the 6 operators can be programmed with its own envelope. Generally speaking, if an operator acts as a *carrier* in a given algorithm, its envelope controls the *volume* of the note. If an algorithm acts as a *modulator*, its envelope controls the *timbre*. (This is a useful conceptual model, although somewhat of an over simplification.)

Illustrated here is a copy of the envelope diagram near the upper right corner of the synthesizer front panel. We have a few additional notes of explanation. The illustration is an aid to visualizing the DX7 envelope settings as you program or edit a voice. There are actually trillions of possible envelopes you can define with these EGs.

Each envelope generator in the DX7 permits you to set 4 different LEVELs and to set 4 specific RATEs at which the envelope moves from each level to the next. We use the term "level" rather than "volume" or "tonal value" because the envelope of the operator you're adjusting could affect the volume or timbre depending on the operator's location within the algorithm.

LEVEL 1 (L1) is the level to which the operator begins moving as soon as you press down the key. The operator may reach L1 almost instantaneously, or it may take

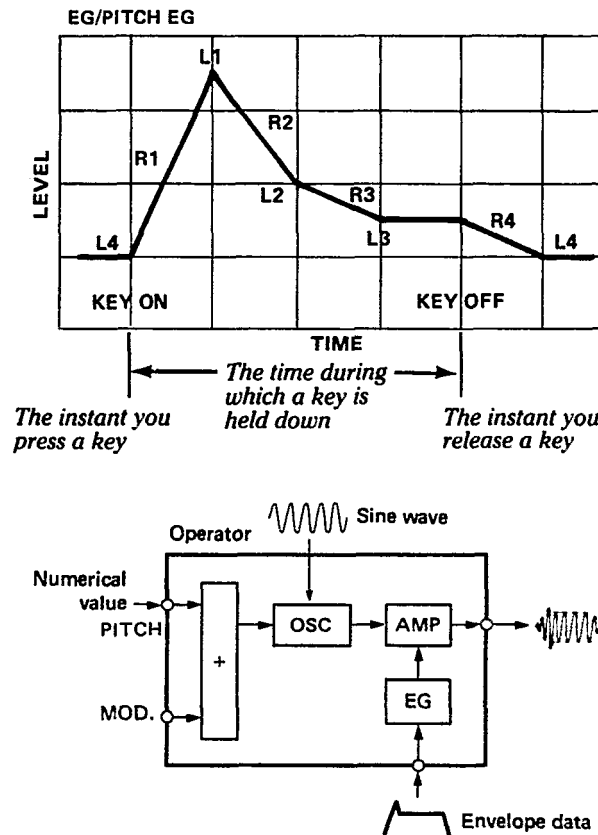

over a half a minute to reach LEVEL 1, depending on the setting of RATE 1 (R1).

*NOTE If you are familiar with analog synthesizers that have Attack-Decay-Sustain-Release envelope generators (ADSR EGs), you may recognize the line defined by R1 and L1 as the "attack" portion of the envelope. There are parallels between a conventional ADSR EGs and the DX7's EGs. However the DX7 envelopes are much more flexible than ADSR types because the DX7 offers 8 precisely programmable parameters (R1, L1, R2, L2, R3, L3, R4, L4) instead of 4 (A-D-S-R). It's not really important for you to understand ADSR envelopes when you're programming the DX7, but if you already do and are curious about the comparison, see the envelope discussion in the Advanced Programming Notes section of this manual.*

When the operator reaches LEVEL 1, it doesn't stay there. Instead it immediately begins moving toward the next level in the envelope, LEVEL 2, and it moves to LEVEL 2 at RATE 2 (R2).

The change from LEVEL 1 to LEVEL 2 can be an increase in level, or a decrease in level, depending on the values you have chosen for these points in the envelope. If, for example, you set LEVEL 1 at the mid point, and LEVEL 2 at maximum, when you play a note, the level of the operator will increase to LEVEL 1 and continue increasing to LEVEL 2. If RATE 1 and RATE 2 are similar, you won't hear two distinct envelope segments. Instead there will be one smoothly increasing sound. Suppose, however, that RATE 1 and RATE 2 are quite different — say RATE 1 is slow and RATE 2 is fast. In that case, you'll hear a distinct "knee" as the sound slowly reaches LEVEL 1 and then jumps to LEVEL 2 at the faster rate.

If LEVEL 2 is lower than LEVEL 1, then the sound will begin decreasing in level as soon as it reaches LEVEL 1, falling to LEVEL 2 at RATE 2. If LEVEL 1 and LEVEL 2 are both set to the same level (other than zero), RATE 2 has no meaning since the sound is already at LEVEL 2 the instant it reaches LEVEL 1; therefore set it to 99. In any case, the sound continues to move on to LEVEL 3.

The sound moves from LEVEL 2 to LEVEL 3 (which may be higher, lower or the same as LEVEL 2); the transition occurs at RATE 3. You may see the similarity between the second and third segments of the DX7 envelope illustrated (LEVEL 1 to LEVEL 2 and LEVEL 2 to LEVEL 3) and the decay portion of a standard ADSR. If LEVEL 1 is the highest level in the envelope, LEVEL 2 is lower, and LEVEL 3 is still lower, you have a 2-stage decay to LEVEL 3. If, on the other hand, LEVEL 3 is set higher than LEVEL 2, then only the LEVEL 1 to LEVEL 2 segment is a decay, and the LEVEL 2 to LEVEL 3 segment becomes a secondary attack (at RATE 3) to the higher level.

LEVEL 3 is different than the first two because when it is reached, the sound does not automatically move toward the next level. Instead, the sound remains at LEVEL 3 for as long as you hold down the key.. or if a sustain pedal is used, for as long as you step on the pedal. LEVEL 3 thus corresponds to the sustain level in a conventional ADSR envelope.

When you stop pressing on a key (or lift your foot from the sustain pedal), the sound immediately begins moving toward LEVEL 4 at RATE 4. It makes no differ-

# PROGRAMMING VOICES: A TUTORIAL

ence whether the envelope had reached LEVEL 3 and was sustaining, had just reached LEVEL 2, or had not yet reached LEVEL 1. Whatever the level when you release the key, the sound immediately moves toward LEVEL 4 at RATE 4. At the slowest setting for RATE 4, the sound can linger for so long that you think the note is stuck (up to 3 minutes). Typically LEVEL 4 is set at zero (minimum or "off") so that the note eventually turns off. RATE 4 is analogous to the release time in a standard ADSR.

A major advantage of the DX7 envelope is that each of the 8 parameters can be set to any of 100 values, providing precision and repeatability. The maximum value of each LEVEL setting is 99, with a minimum value of zero (off). Similarly, the maximum rate is also 99 (fastest change in level). Mathematically, this works out to provide something over 1,000,000,000,000,000 different envelopes (that's right, 15 zeroes!).

*NOTE: If you program a carrier envelope so LEVEL 4 is greater than 0, the sound will not die. If you program RATE 4 at or near 0, the sound will seem to last "forever" Even if you then reset LEVEL 4 to 0 and RATE 1 to 99, the sound will continue until you play 16 notes, the 16th note cancels the last "lingering" note that was programmed with the previous settings.*

## Two basic approaches to creating your own sounds on the DX7.

There are two basic approaches to programming the DX7. First, you can run through all the available preset voices, choose one that is close to the sound you want, and then edit that voice to create the sound you want. Second, you can "initialize" the editing buffer of the DX7 and create a voice "from scratch," one that does not rely at all upon any previously created voice.

The first method, editing a preset voice, is generally a much more efficient approach, provided the sound you want is close to something that already exists. (We don't mean to say that you can't edit an existing voice into something radically different, but the knowledge and effort required to do that in a predictable fashion are formidable.) If you are looking for a unique voice that is totally unlike any preset, it is probably best to start "from scratch." The decision about which approach to use will become easier as you gain experience with the DX7.

Initially we urge you to read this section and follow instructions carefully as we give you a "guided tour" of the DX7 and show you how to program a voice "from scratch." This may seem more difficult, but it is actually a much better way for you to learn how each of the editing parameters (functions) really works. In the beginning, it may seem almost overwhelming due to the unfamiliar terminology and technology. However, as you become familiar with the instrument and gain a working knowledge of envelopes, frequency ratios, keyboard scaling, and so forth, you'll find creating a voice "from scratch" will become much easier, and editing an existing voice (a preset or one of your own prior creations) will become a fast, relatively simple process.

## Programming a voice "from scratch"

In order to begin programming a voice "from scratch," you'll want to have a clear memory location so that when you've completed working on the voice, you can save it. Actually, any of the DX7 internal memories can be used. Nothing is erased while you are creating a voice, but when you're done and you store the new voice in one of the memories, whatever voice had been in that memory will be erased.

*CAUTION If you are using the synthesizer after someone else has been programming voices, make sure those voices have first been stored on a RAM cartridge before proceeding. Otherwise you might accidentally "erase" or change someone else's efforts.*

In this section of the manual, we present information in an order which should make it possible for you to achieve immediate, audible and satisfying results as you learn to program a voice. To aid in organization of the information, we have used subheadings that often use the name of the button, or that describe the use of several buttons which, together, achieve the programming function being discussed. Many of these subheads include their own step-by-step instructions. We intentionally restart with Step 1 for each subhead so that you can later review a single subhead and follow the steps for programming that particular parameter. Once you have become familiar with the DX7, there is no "rule" that you have to follow this order. For now, however, please read and follow these instructions as presented.

*NOTE If you do jump ahead and "get lost" or should you accidentally program one parameter when you thought you were working on something else, an "emergency bail out" is always available: return to the [VOICE INIT] function presented here at the beginning of this section. Turning power off and on will NOT reset your voice.*

## VOICE INITIALIZATION

When you want to program a voice "from scratch," you do it by initializing a voice. That is, regardless of which voice you are currently playing, you reset all its parameters to a starting point which is about the simplest setting that will still produce a sound. This could take many minutes of button pushing if you had to manually check each programmable item. To save time, you can instead use the [VOICE INIT] function. Although you gain access to "Voice Initialize" from the FUNCTION mode, the actual voice is not programmed with the DX7 in FUNCTION mode. As soon as you have performed the steps below to initialize the voice, the DX7 is automatically placed in the EDIT mode, and then the programming begins.

1. To gain access to the "Voice Initialize" function, press [FUNCTION], and then [VOICE INIT], and answer the displayed prompts.

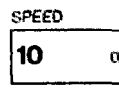
Press This 

and see This

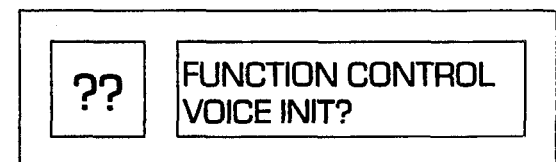



- Assuming you want to initialize the voice edit memory (buffer), answer affirmative by pressing [YES]. (If you changed your mind and don't want to initialize a voice, press [NO]; the display won't change, but the voice will not be initialized and you can select any other function you wish.)

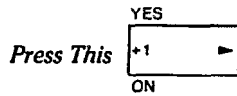

and see This

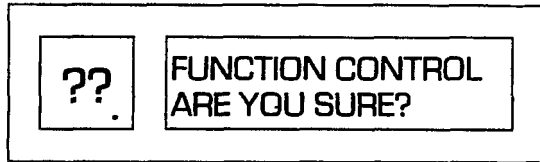

- The DX7 gives you one last opportunity to avoid wiping out any voice which you might have been creating by asking "are you sure you want to initialize the voice editing memory?" In this case you are sure, so answer [YES] again. (If you answer [NO], the display won't change, but the voice will not be initialized and you can select any other function you wish.)



And see This

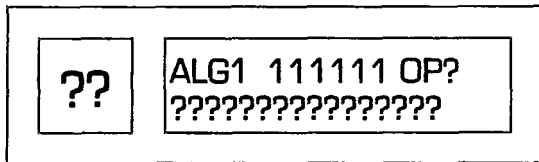

- The memory number in the LED display will be whatever had been last selected, but this has no effect here. Also, the particular operator displayed at the top right, and the editing parameter displayed on the bottom line may vary because the DX7 will show the last used functions or settings. However, it will always initialize to algorithm 1 with all 6 operators enabled (turned on).

### What is initialization?

What have you just done? You have created a "blank" in a special memory called the editing buffer. That buffer memory normally contains the same cartridge or internal memory voice you have selected to PLAY or EDIT. However, once you have "initialized" the editing buffer, it no longer contains the same information. Instead, it contains a special "initialized" voice. That voice is nothing more than a sine wave (a pure tone) which is either on or off.

Remember there are 6 operators. Again, you can think of these as 6 individually pre-settable sine wave oscillators each with its own envelope generator that defines how the operator level changes when you play a note. In the "initialized" voice, all the operator's EG are set to produce an envelope with a "square" shape. That is, when you press a key to play a note, the operator (the sine wave carrier in this case) is on, and when you release the key and the operator is immediately off. Try playing a few notes and hear for yourself.

All operators' output levels are set at 0 except operator 1, which is set at maximum output level (99). In this case, algorithm 1 is automatically selected by the initialization. This algorithm has 2 carriers and 4 modulators: operator 1 is a carrier (at the bottom of one stack). Because operator 1's output level is fully on, you can hear the sine wave it produces. You hear only a pure tone because the other operator's levels are at 0, effectively turning them off even though the operators are "available" because their envelopes are "on". Thus there is nothing to modulate operator 1, nothing to produce the harmonics which might create various timbres.

The pitch of each operator is set to frequency ratio mode at 1.00, so when you play a "C" you hear a corresponding pitch, as explained in one of the following subsections. There is no transposition, keyboard scaling, detuning of the operators, feedback, etc. In other words, all "enhancements" are turned off.

### How to Interpret the display

Now let's "decode" the display so you can understand the useful programming information being presented.

*This is the ALGORITHM number, from 1 to 32. Since you just used VOICE INIT, the display shows that algorithm \*1 has been selected.*

*The red LEDs show the last voice number which had been selected, although this is not what you'll hear now.*

*These digits represent 6 operators. A "1" means the operator is turned on, and a "0" is OFF. All 6 operators are ON here (you can't see yet that operator 2, 3, 4, 5 & 6 output levels are zero.)*

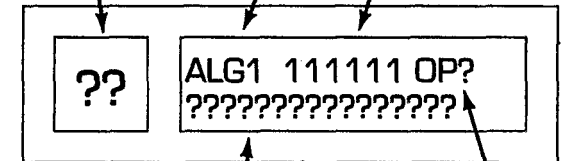

*This shows which parameter is ready to be adjusted with the [DATA ENTRY] controls, and also the current value of that parameter.*

*If this displays "OP\*" it is showing which of the 6 operators will be affected by moving the [DATA ENTRY] controls. If no OP\* is displayed, the parameter shown on the bottom line will affect the voice as a whole and not the individual operators.*

### Looking at the initial EG settings

Since the envelope is one of the primary factors that you use to distinguish different sounds, we'll begin programming with the EG (envelope generator) parameters.

- Press the [EG LEVEL] button, and observe the display. You can now examine and/or change one level at a time in the envelope for whichever operator is the "current" operator. **DO NOT PRESS ANY OTHER BUTTONS OR MOVE ANYTHING UNTIL YOU FOLLOW THE NEXT STEP.**

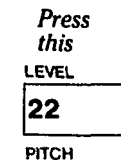

And see this

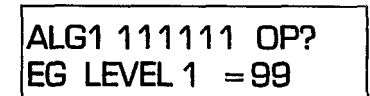

The "current" operator is that one whose parameters are being displayed, and which is ready to be reprogrammed. You can see which one is current (OP1 through OP6) by looking at the upper right hand corner of the LCD display A "?" is illustrated here because we don't know which operator is current (that is not reset by the VOICE INIT function).

2. Press [OPERATOR SELECT] as many times as necessary until the upper right corner of the display shows OP1; if OP is already displayed, you can skip this step.

Press this as required 

Until you see this

```
ALG1 111111 OP1
EG LEVEL 1 =99
```

*NOTE At this point, operator 1, a carrier, is the only operator contributing to the sound because the output levels of operators 2 through 6 were set at zero when you initialized the voice. If you were to play the keyboard with the display showing "OP2" or any other operator you would be hearing only operator 1. If you were to then go ahead and adjust the envelope of an operator other than OP1, you would not hear anything change because only operator 1 is contributing to the sound in the DX7's current status. This step, selecting the "current operator" to be OP1, is necessary so that you will hear the results of the adjustments we ask you to make in subsequent steps.*

3. Lets just look at the 4 levels for this envelope without changing them. The display should already show you that Level 1 is set at 99 (the maximum), as illustrated above. Press [EG LEVEL] 3 additional times, examining the display each time you press the button. Notice that Level 1, Level 2, and Level 3 are all set at 99, but Level 4 is at zero. Normally Level 4 will be set to zero because if it is at a non-zero point the sound will not fall to silence when you release the key (A Level 4 value higher than zero is something like latching the Voltage Controlled Amplifier (VCA) open in a conventional synthesizer.)

In the previous step you saw this

```
ALG1 111111 OP1
EG LEVEL 1 =99
```

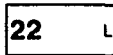
Now press this 3 times  LEVEL 22 PITCH

And watch the display

```
ALG1 111111 OP1
EG LEVELS =99
```

```
ALG1 111111 OP1
EG LEVELS =99
```

```
ALG1 111111 OP1
EG LEVEL 4 = 0
```

4. Lets look at the 4 envelope rates. Press the [EG RATE] button, and the display will now show you Rate 1. Press it 3 additional times to see the remaining 3 rates. Both EG Rate and EG Level work like this, in a continuous cycle through the 4 available points.

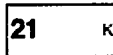
Press this 4 times  EG RATE 21

And watch the display

```
ALG1 111111 OP1
EG RATE 1 =99
```

```
ALG1 111111 OP1
EG RATE 2 =99
```

```
ALG1 111111 OP1
EG RATE 3 =99
```

```
ALG1 111111 OP1
EG RATE 4 =99
```

This envelope, with all maximum levels (except Level 4) and maximum rates defines a "square" envelope that turns on to maximum level the instant you press a key and turns off completely the instant you release the key. If you could see the envelope, it would look like this:

*This is what the "initialized" envelope would look like if you could see it. You can hear it, though.*

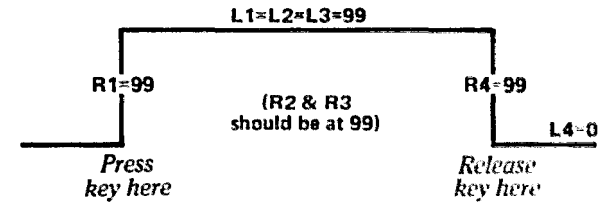

Actually, since L1 and L2 and L3 are the same, R2 and R3 should be set to 99 here to avoid anomalies. This rate does not affect the "square" envelope; because the level does not have to change in this part of the envelope, the rate of change is inconsequential. R1 (where the sound first builds to L1) and R4 (where the sound falls to L4) do have an effect, as we are about to demonstrate.

### Experimenting with the EG

Now lets alter the initial envelope to cause the volume to gradually work up to the maximum (the L1/L2/L3 level), and then gradually reduce to zero (the L4 level)

1. Press EG RATE as many times as required so the display shows Rate 1 (it should be just once if you followed the previous instructions to the letter.) Then move the [DATA ENTRY] slider until the rate changes from 99 to 25, stopping several times to play the same note so you can hear the changes that recur at slower and slower rates.

You may find it easier to press the [<] and/or [>] buttons to precisely set the rate after using the [DATA ENTRY] slider to get close to 25. When you're done experimenting with Rate 1, leave it set at 25.

*NOTE The slower the rate, the longer it takes for the note to build to the maximum level. You can experiment with rates below 25, but you'll have to wait a long time for each note to develop. When Rate 1 is 0 and Level 1 is 99, the sound will take about 40 seconds to reach maximum intensity;*

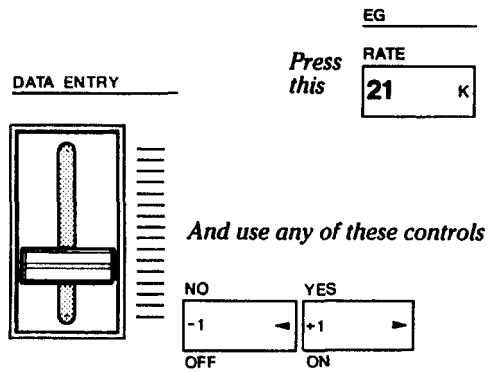

So the display changes from this

ALG1 111111 OP1  
EG RATE 1 =99

To this

ALG1 111111 OP1  
EG RATE 1 =25

With all levels at the maximum of 99 (except Level 4, which is at 0) and with Rate 1 at 25 instead of the 99 to which the other rates are set, the note builds up slowly when you press a key and turns off the instant you release the key. If you could see the envelope, it would look something like this:

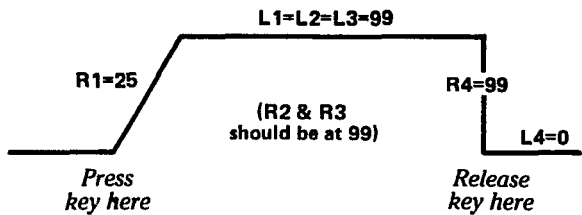

- To change the envelope so the sound gradually falls to silence when you release the key you must lower Rate 4. Press [EG RATE] 3 times so that Rate 4 appears in the display and then use [DATA ENTRY] to change the rate from 99 to 25.

The display should change from this

ALG1 111111 OP1  
EG RATE 4 =99

To this

ALG1 111111 OP1  
EG RATE 4 =25

- Press a key, wait for the note to build to maximum volume, release the key and observe how long the sound lingers. At the slowest rate (0), it takes about 3 minutes for the sound to decrease to complete silence. (You'll need to push the DX7 [VOLUME] slider up and/or turn up the volume of the amplifier in order to hear the last portion of-a long release time.)

With all maximum levels at 99 (except Level 4), Rate 1 at 25 and Rate 4 at 25, the note builds up slowly when you press a key and turns off even more slowly when you release the key. This points out an interesting fact about the DX7 envelope rates. Given any setting (25 in this case), the actual rate of change in level will be faster when the level is increasing, and slower when the level is decreasing. In other words, the *actual rate* is dependent on the *relative levels*.

If you could see the envelope, it would look something like this:

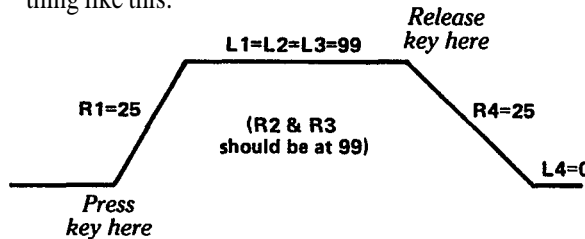

- To explore the middle of the envelope, press [EG LEVEL] until Level 3 is displayed, then adjust [DATA ENTRY] to obtain a Level 3 value of 80. When you now play a note, observe that it builds to a maximum value (L1 and L2=99), then instantly drops to a lower value (L3=80), where it will remain as long as you hold down the key.

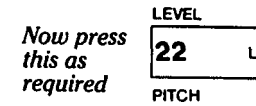

To again see this display

ALG1 111111 OP1  
EG LEVEL 3 =99

DATA ENTRY

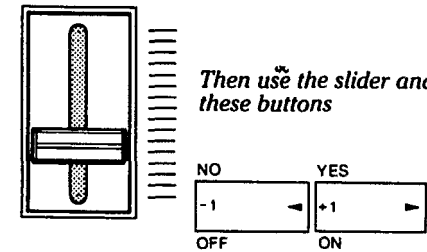

To set this

ALG1 111111 OP1  
EG LEVEL 3 =80

If you could see the resulting envelope, it would look something like this:

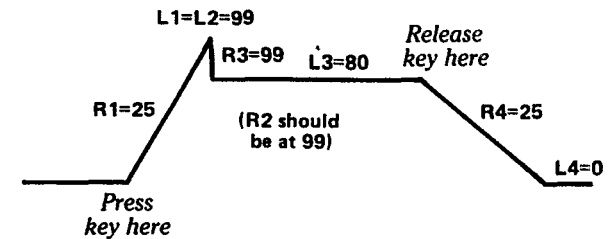

- The drop to Level 3 from the peak at Level 1 (which is the same as Level 2 right now), is very abrupt due to the fast setting of Rate 3. To slow it, press [EG

RATE] as required so you can use [DATA ENTRY] to adjust Rate 3 to a value of 50.

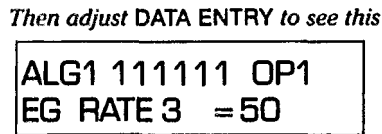
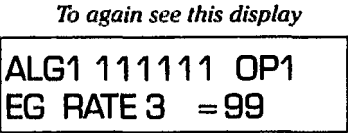
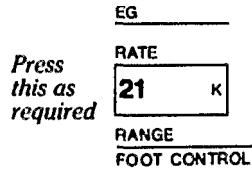

When you play a note, observe how the sound builds to a maximum, then falls to the sustain level at a moderate rate and stays there until you release the key, after which the sound slowly fades. If you could see this new envelope, it would look something like this:

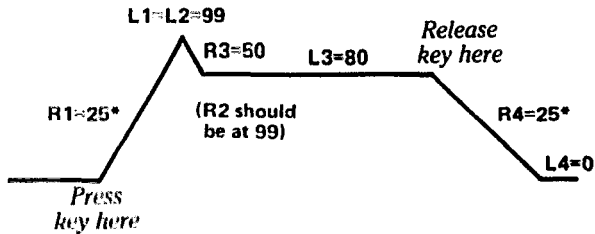

*\*The DX7 envelope rates are internally programmed so that each segment of the envelope behaves similarly. A level of 99, whether it is LEVEL 1, 2, 3 or 4, is always the same. However, as mentioned in the preceding text, when a given rate is used for moving from a lower to a higher level, that rate will be faster than if the envelope is moving from a higher to a lower level. This is done because naturally occurring "attack" times are typically faster than "decay" or "release" times. If all rates were scaled identically you might have to work with the highest numbers for attacks and the lowest numbers for decay or release. Instead, the DX7's "smart" programming lets you maintain a full 100 step resolution within the range you need it. This explains why even though Rate 1 and Rate 4 are both 25 in this case. Rate 1 is faster; it is an upward moving rate.*

*NOTE If you are familiar with ADSR envelope generators, you'll probably see the similarity between this envelope and the typical ADSR envelope. However, we have not yet "used" Level 2, and it can significantly alter the situation, as you'll now learn.*

- Press [EG LEVEL] until LEVEL 2 appears in the display then adjust [DATA ENTRY] for a value of 45. Then press [EG RATE] until RATE 2 appears in the display and adjust [DATA ENTRY] for a value of 50. Play a note and hold the key down for a full minute, then release the note.

When you play the note, observe how the sound builds to a maximum, then falls to almost nothing, then builds to the intermediate sustain level and stays there until you release the key after which the sound slowly fades. This "double" note is made possible by the 4-segment envelope which, if it were visible, would look something like this:

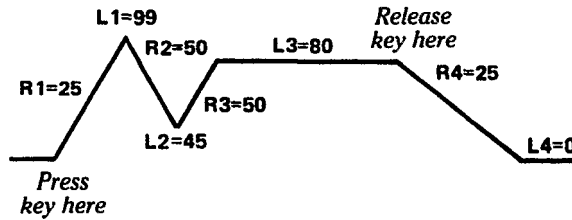

- At this point, you're ready to see one more "fine point" about how the envelope functions. We showed you how Rate 4 adjusts the release of the note as it fades from Level 3 (the sustain level) to Level 4 (the final level) which was set at zero. In fact, Rate 4 sets the release time from whatever level the envelope has achieved at the instant you release the key

This may seem a subtle distinction, but you can hear it by experimenting with the envelope you have just created.

- Hold down the key until the note is well into Level 3 (the sustain level). Then release the key, and listen to the length of time it takes for the sound to decay. Play several more notes, and compare that time to the rather short time it takes for the sound to fall from the initial peak at Level 1 to the low point at Level 2. The difference is because Rate 2 is 50, which is considerably faster than Rate 4, which is 25.
- Now play a note and let go of the key just as the sound reaches the first peak at Level 1. Notice how

long it takes for the sound to die away. Even though Rate 2 and Level 2 are the next segment programmed in the envelope, the sound is not moving toward Level 2. Instead, because you released the key the sound moves from Level 1 directly toward Level 4. That's why Rate 4 (the slower rate) applies.

Remember, what you hear is coming from the same EG settings you had established in Step 6 above. If you could see what happens when you "prematurely" let go of the key, the envelope might look like this.

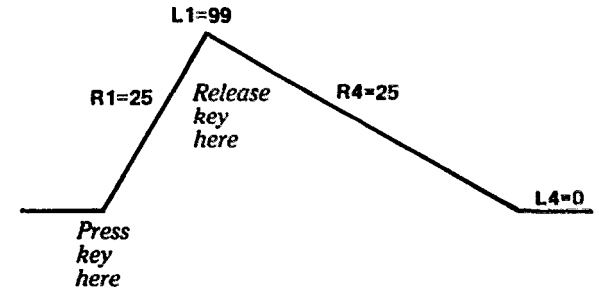

### Learning to change the operator FREQUENCY settings

The frequency of the sine wave produced by each operator can be set so it follows the keyboard. This characteristic is set with the [OSCILLATOR-MODE/SYNC] button, and is called "Frequency Ratio" mode because the frequency produced when you play a key is not necessarily tuned to the pitch of that key; it can be multiplied by almost any number you wish by using the [OSCILLATOR-FREQUENCY COARSE] and [OSCILLATOR-FREQUENCY FINE] adjustments to reprogram the operator. For most voices, the DX7 is set to this ratio mode. (The Voice Initialize function also sets the DX7 to ratio mode.)

The frequency does not have to follow the keyboard, however. Instead, it can be set to a single frequency that does not change regardless of which key you play. The "REFS WHISTL" voice of the "Master Group" on the #3 DX7 VOICE ROM uses this "Fixed Frequency" mode.

While you can adjust the frequency characteristics of operator 1 (fixed/ratio mode and actual frequency) using the envelope you just created, we recommend changing the envelope. The sustain level (Level 3) is now at 80, and if you hold down a key to experiment with the frequency settings, you will not hear it at full volume.

Instead of taking the time to reprogram the envelope, we ask you to again use the Voice Initialize feature... it saves time.

- To gain access to the "Voice Initialize" function, press [FUNCTION], and then [VOICE INIT], and answer the displayed prompts.

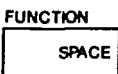
Press this 

Then, if the display does not show "VOICE INIT?", press this

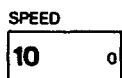
  
VOICE INIT

Either way, you should see

FUNCTION CONTROL  
VOICE INIT?

- Then press [YES] twice to initialize the edit memory (buffer).

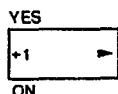
Press this 

And see this

FUNCTION CONTROL  
ARE YOU SURE?

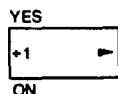
Press this again 

And see this

ALG 1 111111 OP1  
EG RATE 2 = 99

The display shows "EG RATE 2 = 99" for two reasons. First, the programming parameter displayed is whatever parameter you had last adjusted. In this case, going back to Step 6 of the previous instructions, you had set Rate 2 at 50, so "RATE 2" is displayed. The value, however, is not 50, but is 99, since, as you

know, the "initialized" envelope has all rates at 99. Play a note and you'll hear the DX7 is back to the "square" envelope.

- Now press [OSCILLATOR-FREQUENCY COARSE] and operate the [DATA ENTRY] slider and/or buttons while playing a note. Watch the display as you listen to the pitch change.

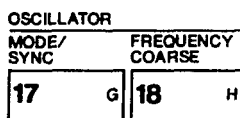
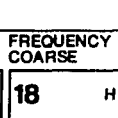
Press this   
  
RANGE PITCH  
MODULATION WHEEL

DATA ENTRY

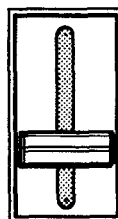

Then use the slider and/or these buttons while continuing to play Middle C

NO YES  
-1 +1  
OFF ON

ALG1 111111 OP1  
F COARSE = 1.00

And watch this \*

ALG1 111111 OP1  
F COARSE = 0.50

Minimum

ALG1 111111 OP1  
F COARSE = 31.00

Maximum

**CAUTION** Don't turn up the volume too high or hold a note very long at the higher frequency ratios or you can easily damage the high frequency driver (tweeter) in your speaker system. There's nothing "wrong" with the synthesizer for "letting you" program such high frequencies. The very high frequencies are useful at low levels as part of a voice, or for modulating with other frequencies in order to produce lower frequencies that are clearly audible. Unless you're programming dog whistles or ultrasonic alarm simulations, you won't ever use a ratio near 31.00 as a fundamental pitch for a carrier.

**NOTE** The pitches you hear as you move the [DATA ENTRY] slider constitute the Harmonic Series of the note you are playing. When the display indicates "F COARSE = 1.00" the "1.00" part is the frequency ratio. The "FCOARSE" part merely tells you that the adjustments you make will be coarse. With the exception of the "0.50" ratio, all COARSE adjustments are integer multiples of the fundamental frequency of the note. That is, "1.00" is the fundamental, "2.00" is 2 times the fundamental frequency and so forth. If you play a middle C, "1.00" is 262 Hz, "0.50" is 131 Hz (262 x 0.5), "2.00" is 524 Hz (2 x 262), and "31.00" is 8,122 Hz (31 x 262). The reason we suggest playing Middle C is that if you play notes at the higher end of the keyboard, by the time you increase to a ratio of 31.00, you will not be able to hear the pitch because it will be above the range of human hearing. Speaker performance is also a factor at these very high frequencies. If you play the A which is normally 440 Hz when the ratio is "1.00" but change the ratio to "31.00", the actual frequency is 13,640 Hz. That is near or beyond the point where many speaker systems "roll off," so even if your ears are good, you may have difficulty hearing it. Play an A one octave lower and the frequency is cut in half, so you'll have no trouble hearing this same 31.00 ratio.

- Adjust [DATA ENTRY] so the ratio is 1.00 again.
- Now press [OSCILLATOR-FREQUENCY FINE] and operate the [DATA ENTRY] slider and/or buttons while playing a note. Watch the display as you listen to the pitch change.

Press this **19**

FREQUENCY FINE  
AMPLITUDE

DATA ENTRY

Then slowly move this slider up and down fully, or use these buttons while continuing to play a note

NO YES  
-1 +1  
OFF ON

ALG1 111111 OP1  
F FINE = 1.00

ALG1 111111 OP1  
F FINE = 1.99

This starting Coarse frequency, in Fine mode, can be raised to this maximum

6. Slide [DATA ENTRY] all the way down so the frequency returns to 1.00, and then press [OSCILLATOR-FREQUENCY COARSE] and use DATA ENTRY [+1] to set the frequency ratio to 2.00.

DATA ENTRY

Slowly move this slider down fully

To again obtain a 1.00 ratio

ALG1 111111 OP1  
F FINE = 1.00

Then press this,

FREQUENCY COARSE  
18 H  
PITCH

To see this

Then press this

YES  
+1  
ON

ALG1 111111 OP1  
F COARSE = 2.00

7. Press [OSCILLATOR-FREQUENCY FINE] again, and slowly move the (DATA ENTRY) slider all the way up. The increments you get with the Fine adjustment will depend on the beginning Coarse setting. The pitch change will seem continuous when the Fine adjustment is selected and you move the [DATA ENTRY] slider, rather than discretely stepped, as it does with the Coarse setting.

DATA ENTRY

Press this **19**

FREQUENCY FINE  
AMPLITUDE

Then slowly move this slider up

ALG1 111111 OP1  
F FINE = 2.00

This starting Coarse frequency, in Fine mode, can be raised to this maximum

ALG1 111111 OP1  
F FINE = 3.98

If the ratio does not quite reach 3.98 when you push the slider up, press the increment button [>] once or more.

YES  
+1  
ON

Notice the maximum increase available with the Fine frequency adjustment is always a little less than twice the beginning Coarse frequency. The "Fine" control multiplies the "Coarse" value by up to 1.99. For example, if you start at a ratio of 1.00, the Fine adjustment will go only as high as 1.99 (just under twice 1.00). Start at 2.00, and the Fine adjustment will go only as high as 3.98. Start at 3.00, and the Fine adjustment will go only as high as 5.94. Start at 31.00, and Fine will take you up to 61.69. Thus you can use a combination of Coarse and Fine adjustments to achieve anywhere from 1/2 the "normal" keyboard pitch to nearly 62 times that frequency — which is

too high to be audible on all but the lowest notes of the keyboard.

8. Slowly bring the [DATA ENTRY] slider all the way down so the pitch returns to a ratio of 2.00. Then press [OSCILLATOR-FREQUENCY COARSE] and then the [-1] DATA ENTRY button to reset the ratio to 1.00. (This should now be identical to the "starting" initialized voice.)

The display should now look like this

ALG1 111111 OP1  
F COARSE = 1.00

### How to create Frequency Modulations getting acquainted with the OPERATOR SELECT, OUTPUT LEVEL and ON - OFF edit featurec

Up to now you have manipulated only OPERATOR 1 which, in ALGORITHM 1, happens to be a carrier. We'll now leave Operator 1 set at the "square" envelope at a frequency ratio of 1.00 (as initialized), and begin exploring what happens when Operator 2 is used to modulate Operator 1. For review, we again point out the Operator On/Off display (which you are about to use) and illustrate Algorithm 1, but with additional information you may now begin to understand.

NOTE If you're "lost" or if it has been a while since you read and followed the instructions in the previous sections, you can start "from scratch" here by pressing [FUNCTION], then [VOICE INIT], then answering [YES] [YES]. The DX7 will now be set as we assume it is for the following instructions. The display however, may not match: if a different editing parameter is shown, press [OSCILLATOR-FREQUENCY COARSE]. Now your display should match the following illustration.

ALG1 111111 OP1  
F COARSE = 1.00

Remember the display of 6 1's tell you the corresponding 6 operators are turned ON at this point in the programming process. The On/Off "switches" are shown in the following algorithm diagram.

ALGORITHM #1

These bracketed numbers show you where the on/off switching is done in the algorithm. Operators can be disabled (turned Off) using the [OPERATOR ON/OFF] buttons, but they remain Off only while programming. Stored voices have all operators On. The reason you have heard only Operator 1 in the "initialized" voice even though all Operators are On, is that all output levels are set to 0, except Operator 1, whose output level is at 99.

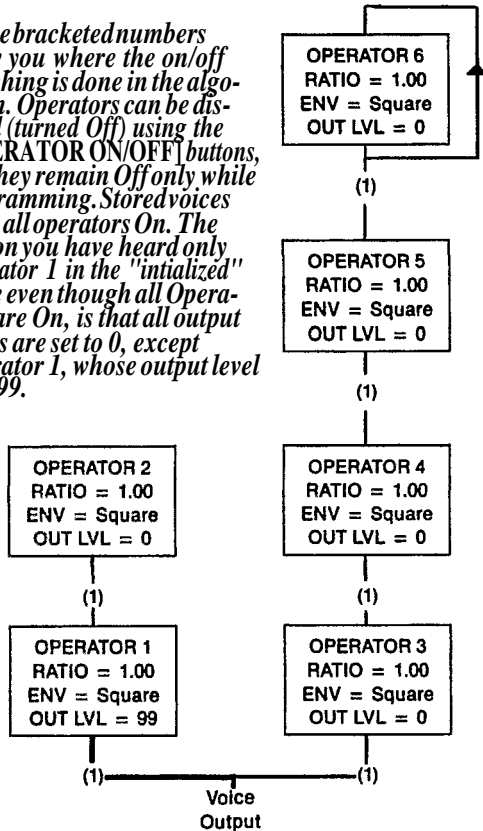

The heavy line shows which operators contribute to the sound: Operator 1 alone in this case

1. Press [OPERATOR SELECT] to change the operator which is set as the "current" operator. The current operator is the one whose parameters are displayed, and which you can program with the DATA ENTRY controls. Even when several operators are turned ON and are contributing to the sound, only one at a time can be adjusted or examined by selecting it as the current operator.

Each time you press the [OPERATOR SELECT] button, the current operator increments by one, and then jumps from 6 to 1 and continues.

Press this at least 6 times

OPERATOR SELECT

Z

ALG1 111111 OP3  
F COARSE = 1.00

And watch the current operator change: 1-2-3-4-5-6-1-2-3 etc.

Leave the display showing OP3.

Since you're only going to be working with operators 1 and 2 at first, this can be annoying if you have to move from operator 2 to operator 1; it requires that you cycle through 3, 4, 5 and 6 to get back to 1. In subsequent steps we show you how to speed the process of selecting the current operator.

2. Since you will not yet be using operators 3, 4, 5 or 6, you can turn them OFF by pressing the corresponding [OPERATOR ON/OFF] buttons once. You won't hear any change in the sound as you play because those operators are not contributing to the sound (their output levels are set to zero).

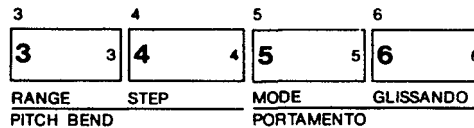

Press each of these buttons once and watch the display change

As soon as you turn off OP3, it cannot be adjusted

So the current OP# automatically goes to the next operator which is On

ALG1 110111 OP4  
F COARSE = 1.00

When you then turn off OP4, it cannot be adjusted

So the current OP# goes to the next operator which is turned On

ALG1 110011 OP5  
F COARSE = 1.00

The same thing happens when you turn off OP5

This moves to the next operator

ALG1 110001 OP6  
F COARSE = 1.00

The same thing happens when you turn off OP6

This moves to the next operator

ALG1 110000 OP1  
F COARSE = 1.00

As you can see, the DX7 automatically performs the OPERATOR SELECT function if you turn OFF an operator that is set as the current operator.

3. Now press [OPERATOR SELECT] several times and observe that the display only moves between OP1 and OP2. Leave it set to OP2.

Press this a few times

OPERATOR SELECT

Z

You can select 1 or 2 only

ALG1 110000 OP2  
F COARSE = 1.00

Leave the display showing OP2.

4. In the last 3 steps you have pressed a lot of buttons, but if you bothered to play any notes, you will have noticed that the sound did not change. In order to modulate operator 1 and create harmonics, you have to bring up the output level of operator 2.

Press [OPERATOR-OUTPUT LEVEL] and then move the [DATA ENTRY] slider up to increase the level from 0 to 99. Play the note repeatedly as you increase the settings. You probably won't hear much until the level is up near 50.

Press this button (Don't confuse it with [EG LEVEL], button 22)

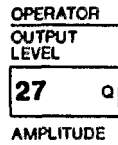

And see this



DATA ENTRY

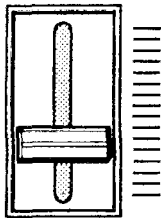

Then move this slider upward slowly

And repeatedly play notes until the display shows maximum output level

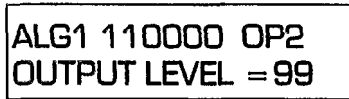

If you are familiar with analog synthesizers, you may see a parallel between this sound and that of a saw-tooth wave which is going through a filter that has a lot of resonance. In fact you are frequency modulating one sine wave with another sine wave; both are set to the same frequency and the same level. There are no filters involved.

Just to review the changes you have made, notice that the right hand stack (Operators 3 to 6) are turned off, while Operator 2's output level is now increased to 99.

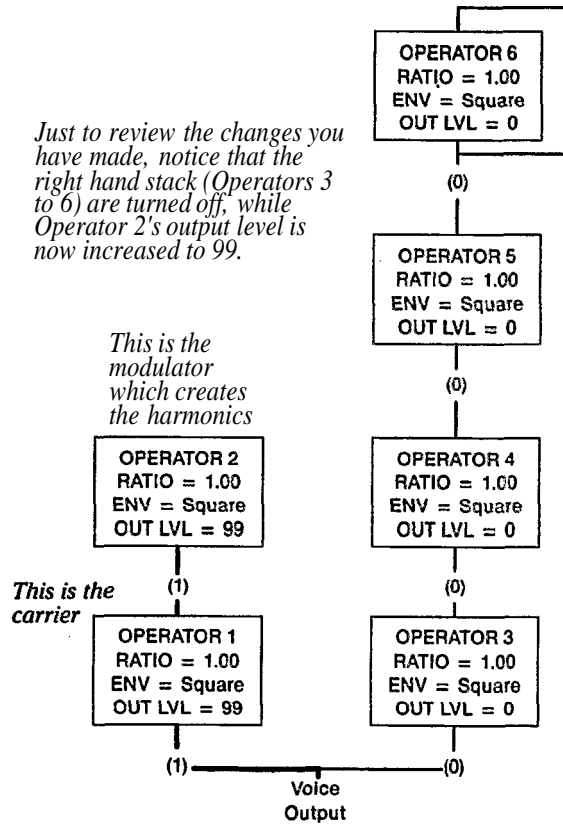

This is the modulator which creates the harmonics

This is the carrier

5. Press the [OSCILLATOR-FREQUENCY COARSE] button and play a note while slowly adjusting [DATA ENTRY]. In fact play several notes at each frequency setting, and observe the sound.

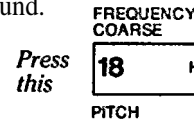

DATA ENTRY

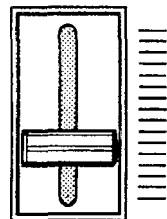

Then move this slider down and gradually raise it or use the [-1] and [+1] buttons while playing

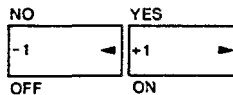

Only the frequency should change in the display

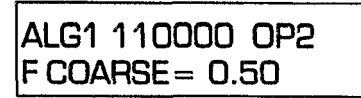

From a minimum of 0.50 to a maximum of 31.00. Listen to each ratio.

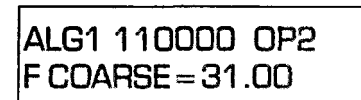

You are changing the entire harmonic structure of the sound by changing the frequency of the modulator. However, because the modulator output level is at maximum, the bandwidth of the harmonics is great (there are a lot of very high frequencies caused by a lot of modulation). Musically, most of these sounds are "extreme". You can achieve rather different sounding results by simply reducing the amount of modulation, as demonstrated in the next step.

6. Press [OPERATOR-OUTPUT LEVEL] and then move the [DATA ENTRY] slider down to decrease the level from 99 to 69. Then press [OSCILLATOR-FREQUENCY COARSE] and again try playing notes as you adjust the modulator frequency.

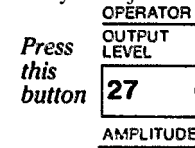

Press this button Make sure OP2 is current

And see this

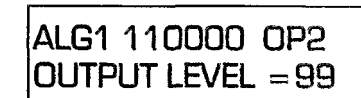

Then move this slider down slowly or press the [-1] button

DATA ENTRY

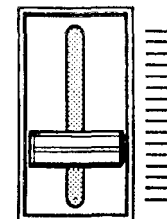

Until the display shows this output level

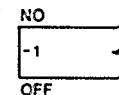
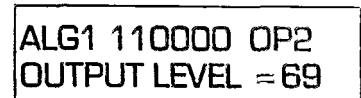



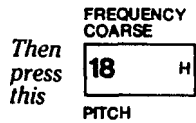

And again adjust [DATA ENTRY] to hear the results of different frequency ratios as you play

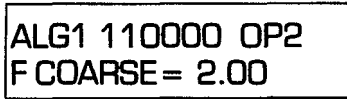

Leave Operator 2 set to a frequency ratio of 2.00

The sound you now hear will be similar to that of a square wave in a conventional synthesizer. In this case, it is created by sine wave modulation of the carrier by another sine wave at twice the frequency, and at a somewhat lower level than the carrier.

This is the modulator which creates the harmonics

This is the carrier

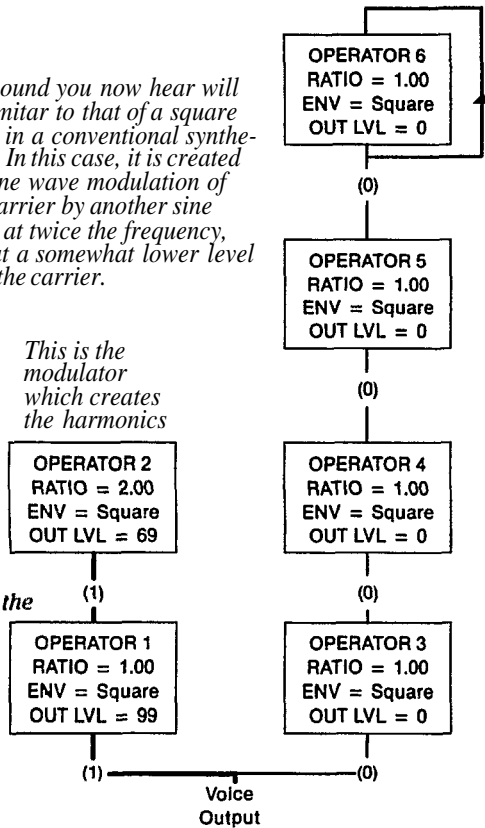

- To compare what the sound is like with and without modulation, you *don't* have to turn down the output level of operator 2; you can simply turn it off. Press [OPERATOR ON/OFF 2] to turn off the modulator, play a few notes, then press the button again to turn the modulation back on.

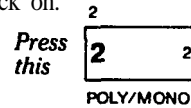

And see the display change from this

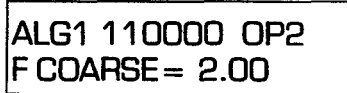

To this

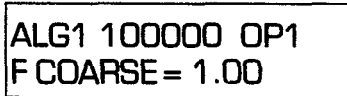

Note that the current operator has automatically switched to OP1; remember it can only be set to an operator that is on.

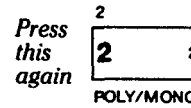

And see the display change to this

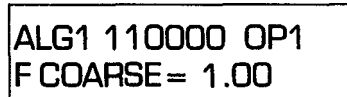

Note the current operator stays at OP1. If you again want to adjust any parameters for Operator 2, you will have to press the [OPERATOR SELECT] button.

- Now let's see what happens when we leave the modulator (Operator 2) set at a frequency ratio of 2.00, and change the frequency ratio of the carrier (Operator 1). Since the current operator automatically switched to OP1 when you turned off OP 2 above, you can just press the [OSCILLATOR-FREQUENCY COARSE] button and play a note while slowly adjusting [DATA ENTRY].

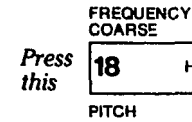

Then move [DATA ENTRY] while playing a note (or several)

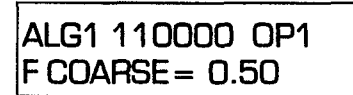

Listen and watch the display as the ratio changes from a minimum of 0.50 to a maximum of 31.00

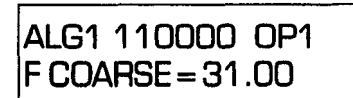

In this case, the effect you get as you move [DATA ENTRY] is similar to sweeping a high pass filter in an analog synthesizer. You're not moving a filter, of course, but instead you are controlling the entire harmonic structure of the note by changing the carrier frequency relative to a particular modulator frequency.

In this case you are leaving the modulator set as is

And varying the carrier frequency ratio.

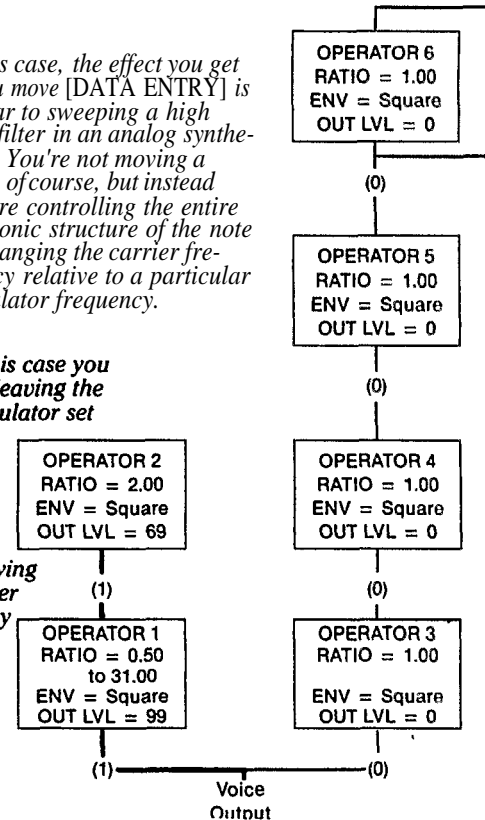

9. To compare what the sound is like with and without the carrier, you don't have to turn down the output level of operator 1; you can simply turn it off. Press [OPERATOR ON/OFF 1] to turn off the carrier, and try to play few notes. (Don't adjust anything else right now.)

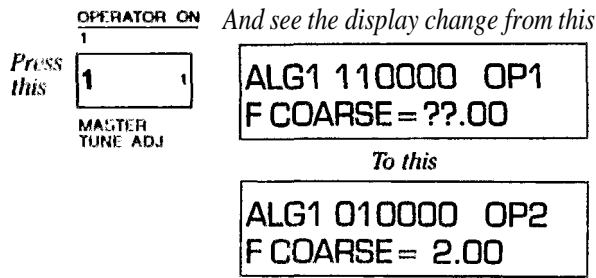

*NOTHING HAPPENS! NO SOUND! That's because you just turned off the carrier, and you cannot hear a modulator (Operator 2) directly; you can only here its effect on a carrier. With the carrier shut off, there is no sound.*

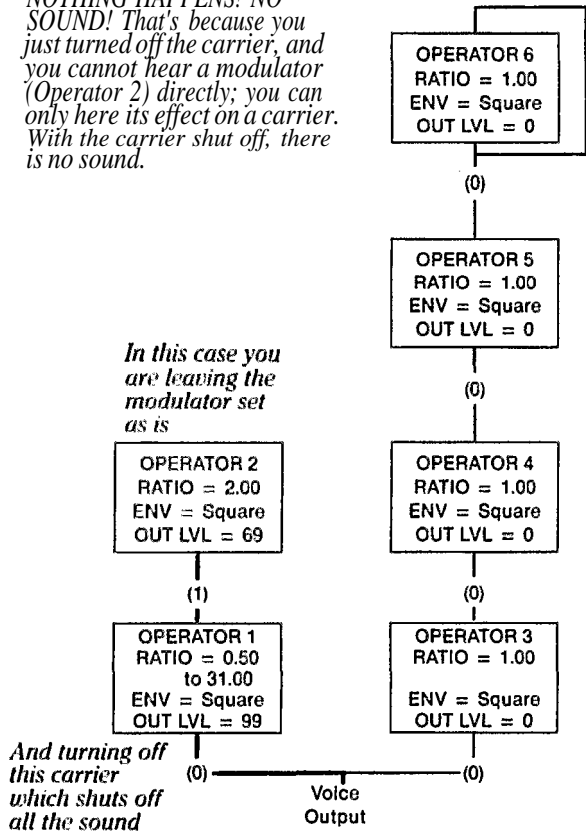

10. Press [OPERATOR ON/OFF 1] again to turn on operator 1 and restore the sound.
- In the previous Step, the reason we asked you not to adjust anything is that the current operator changed to operator 2, and if you were to try pressing edit buttons and moving the slider you would be reprogramming the modulator without realizing it. You would not hear what you were doing.
11. Now press [OPERATOR SELECT] to set operator 1 as the current operator (the one to be adjusted), and adjust its frequency to be 0.50 using the [OSCILLATOR- FREQUENCY COARSE] parameter.

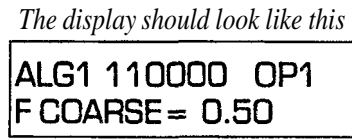

12. To make the sound more interesting, you'll want to change the envelopes of the two operators. Beginning with the current operator (1), change its initial attack rate (Rate 1) and its release rate (Rate 4) using the [EG RATE] button.

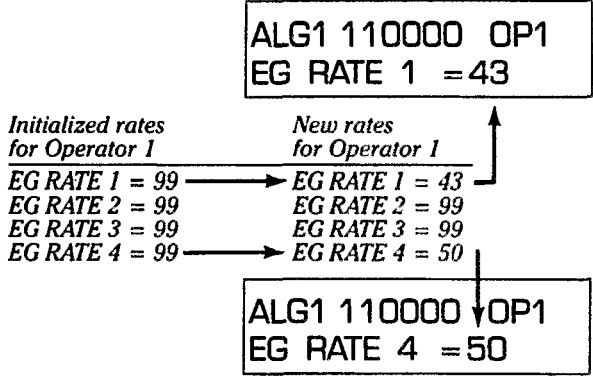

Play a few notes and see how the sound is somewhat more clarinet-like. The square envelope of the modulator causes the note to become "pure" when you release the key We'll correct that situation next. (There is no need to change the EG levels for now.)

<i>Initialized levels for Operator 1</i>	<i>Operator 1 levels remain unchanged</i>
EG LEVEL 1 = 99	EG LEVEL 1 = 99
EG LEVEL 2 = 99	EG LEVEL 2 = 99
EG LEVEL 3 = 99	EG LEVEL 3 = 99
EG LEVEL 4 = 0	EG LEVEL 4 = 0

13. Now change the envelope of operator 2 the same way so that the modulator has the same envelope as the carrier. This is not necessarily desirable in all voicing. In fact the modulators usually have different envelopes. However, right now we want to show you something.

You could press [OPERATOR SELECT], then press the [EG LEVEL] button and adjust the [DATA ENTRY] slider all over again, but there's an easier way. Use the [EG COPY] function by holding down the [STORE] button and then pressing the [EG COPY 2] button. (The 6 Operator ON/OFF buttons are also EG COPY buttons that you use to designate which operator will receive the envelope which is being copied.)

EG COPY copies the entire envelope of the current operator (the one displayed in the corner of the window) into whatever other operator or operators you specify. BE SURE YOU START WITH OP1 in the upper right corner of the display.

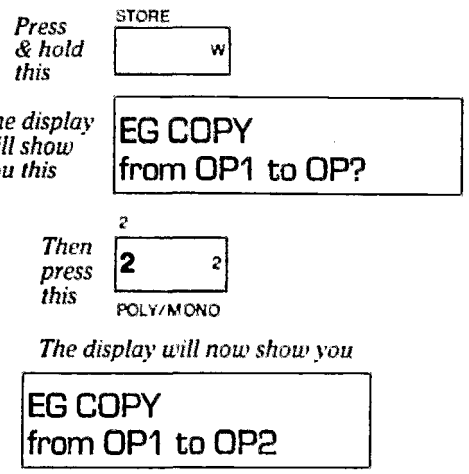

That's it, let go of both buttons. You have just transferred 4 levels and 4 rates from operator 1 to operator 2. Play a few notes. Now the timbre doesn't go "pure" as soon as you release the key

*NOTE* There are still many more editing functions to explore, and we'll use the settings you've just created as a point of departure for the additional functions. If you are ready to go on, please continue, if you want to take a break and relax or have some fun with the

preset voices, you can do so without "losing" this voice. There are two approaches to this.

(A) You can store this voice in its current state on a RAM cartridge by following the instructions on page 49, or...

(B) You can press the [MEMORY SELECT-INTERNAL] or [MEMORY SELECT-CARTRIDGE] button and then play any preset voices you like. Later, even if you've turned power off and then on again, you can return to this voice by doing the following; press [FUNCTION], the [EDIT RECALL], then [YES] [YES].

**Additional editing features: ALGORITHM SELECT, KEYBOARD RATE SCALING, and KEYBOARD LEVEL SCALING**

At this point you have programmed Operators 1 and 2, which serve respectively as a carrier and modulator (as arranged in Algorithm 1), so the frequency modulation creates a woodwind-like character. You have also modified the initialized "square" envelopes to more closely resemble a woodwind instrument. We have not yet created a particularly realistic or even pleasing voice, but that's not the object for now. We are more concerned with showing you how the DX7 may be programmed. Some of the settings we suggest are calculated to most clearly present concepts to you, not to produce the "best" voice. This will continue to be the case as we go on to show you a number of ways to refine the voice.

We ask that you continue to use the settings we recommend. Otherwise, future instructions may not make any sense — sometimes a slight difference in one setting will cause another setting to have no effect or far too much effect. After you've learned how the instrument works, you'll be able to program voices that are pleasing to you.

*NOTE These instructions assume you have followed the instructions in the previous section, and that the DX7 is in the EDIT mode. Before you go on, the display should appear as shown here, and Operators 1 and 2 should be programmed as indicated in the chart.*

*If Operators 3 through 6 are ON (display 111111), turn them off for now (display 110000)*

**ALG1 110000 OP1  
EG RATE 4 = 50**

*Operator 1 should be the current operator, as shown here*

*This parameter doesn't matter for now because you're about to select another one anyway*

This chart represents what you have programmed so far:

EDIT mode PARAMETER	OPERATOR	
	1	2
OUTPUT LEVEL	99	69
FREQUENCY RATIO	0.50	2.00
EG RATE 1	43	43
EG RATE 2	99	99
EG RATE 3	99	99
EG RATE 4	50	50
EG LEVEL 1	99	99
EG LEVEL 2	99	99
EG LEVEL 3	99	99
EG LEVEL 4	0	0

- The difference between algorithms is the difference in the way operators are arranged. Let's try switching the two operators that are turned on and see what happens to the sound. Press the [ALGORITHM] button and then press the DATA ENTRY [+1] button repeatedly to step through algorithms 1 through 32 (or move the slider up slowly). Play a few notes each time you press [>] so you can hear how each algorithm affects the sound.

Press this    
ALGORITHM  
TIME

**ALG1 110000  
ALGORITHM SELECT**

Then press this

**ALG32 110000  
ALGORITHM SELECT**

*To move from algorithm 1 through algorithm 32. Be sure to play and listen to each one.*

Surprised? You can get JUST TWO sounds from the 32 algorithms! This is predictable if you look at the algorithm diagrams; in all cases, operator 2 either feeds into operator 1 (is modulating it) or is adjacent to it (so the sine waves add instead of causing FM synthesis).

In these fragments of several algorithms, operator 2 is always modulating operator 1. This is characteristic of Algorithms 1-19 and 28:

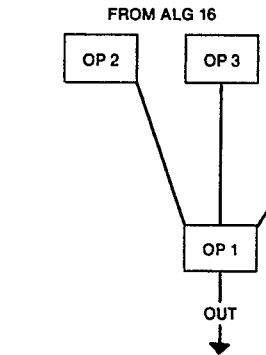
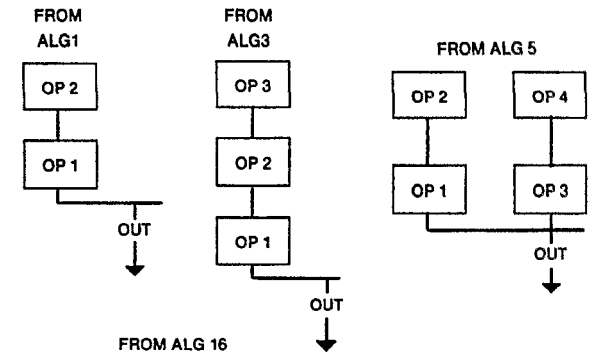

In these fragments of two algorithms, operators 1 and 2 are always adding together. This is characteristic of algorithms 20-27 and 29-32:

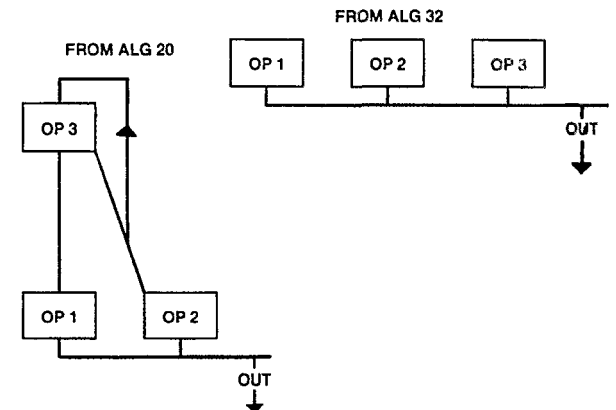

When you later try switching algorithms after adding FEEDBACK and activating the other 4 operators, you'll hear much more variation.

2. Pull down the [DATA ENTRY] slider and/or use the [-1] button until you've selected algorithm 1 again.

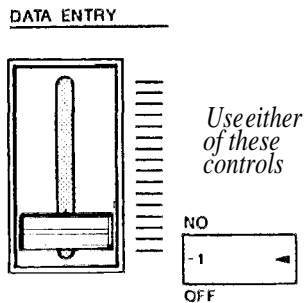

Use either of these controls

To return to algorithm 1

**ALG1 110000  
ALGORITHM SELECT**

3. If you play the lowest note on the keyboard, then the highest, you can hear the same attack and release time. In a natural, acoustic instrument the times would tend to be faster as you move up the scale. This is because a vibrating reed or string, or a resonating column of air can be excited more quickly and will stop moving more rapidly when the string, pipe, etc. is shorter.

You can achieve this effect by scaling the envelope rates across the keyboard to any of 8 values (from 0 to 7), as illustrated.

**KEYBOARD RATE SCALING**

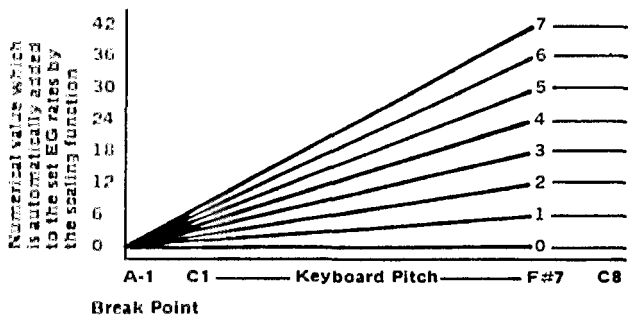

Alternately play very low and then very high notes and listen to the envelope attack and release rates. Then press the [KEYBOARD RATE SCALING] button, and, for the most noticeable effect, push the [DATA ENTRY] slider all the way up so you get a maximum rate scaling value of 7. Then play the same notes again and listen to the rates. The low notes will not change much, but the highest notes will have significantly shorter times. The scaling is not continuously changing with each note, but instead changes the rates for each group of 3 keys on the keyboard. When you've tried the maximum, reset the scaling to a value of 4.

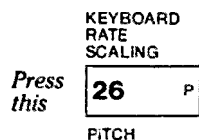

And push up [DATA ENTRY]; leave it set like this

**ALG1 110000 OP1  
RATE SCALING = 4**

4. Much like the envelope rates can be varied across the keyboard, so, too, can the operator output levels. By using the multiple functions of the 3 KEYBOARD LEVEL SCALING buttons, you can obtain 99 [DEPTH] settings on either side of a [BREAK POINT] that you select, and you can also choose any of 4 [CURVE] settings on each side of that break point. You can do this for each of the 6 operators. These selections are diagrammed at the upper right corner of the synthesizer.

These 3 buttons provide access So all the level scaling parameters

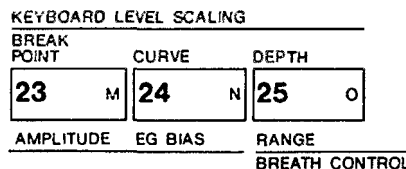

**KEYBOARD LEVEL SCALING**

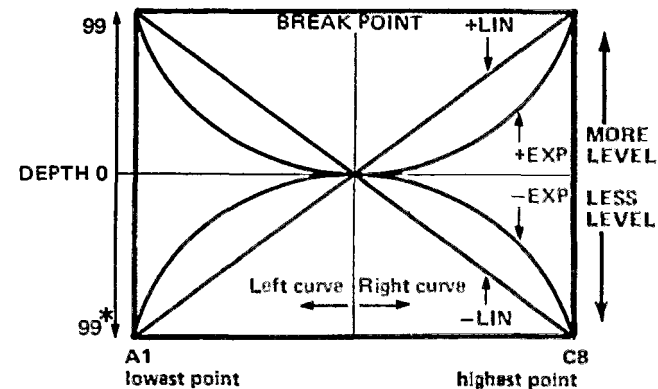

\*With a (-) linear curve set to a depth of 99, the attenuation is 22 dB per octave.

5. If necessary, reset the current operator to operator 1 by pressing (OPERATOR SELECT).

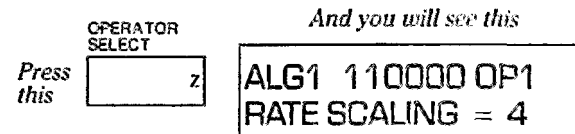

And you will see this

The DX7 is still in rate scaling mode from the previous step.

6. In order to show you an extreme setting, we will "split the keyboard" so that this woodwind-like voice component appears on the upper portion of the keyboard only (When we program operators 3 through 6, we'll scale them so they work primarily on the lower portion of the keyboard.)

Press [BREAK POINT] and then move the [DATA ENTRY] controls as required to obtain a break point of E4.

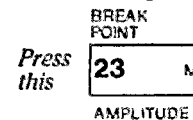

And adjust the [DATA ENTRY] controls to see this

**ALG1 110000 OP1  
BREAK POINT = E 4**

In this case scaling operator 2 is not necessary so you can omit the process of setting its break point (which would be done by pressing [OPERATOR SELECT] and adjusting the value as desired).

Now play some scales and notice that the sound is still reasonably uniform across the keyboard. That's because, while we have selected a break point for the carrier, we have not yet assigned any depth to the curves on either side of the break point.

- Basically there are two types of level scaling curves, LINEAR and EXPONENTIAL. Linear curves seem to cause a more rapid boost or cut and are useful for exaggerated scaling effects, such as keyboard splitting. Exponential curves are similar to the inherent logarithmic sensitivity of our ears and therefore seem more "natural". These curves are useful for simulating the natural changes in level that occur across the range of an acoustic instrument. Of course, the depth and break point make a big difference, as does the operator to which the scaling is applied (modulator or carrier).

Press [CURVE] and observe the display. It will either show the curve set for the left or the right side of the break point. If necessary press the button a second time to ensure that the LEFT curve is displayed. Then adjust [DATA ENTRY], if necessary, to select a "-LIN" curve.

Press this once or twice

CURVE	24	N
EG BIAS		

And adjust the [DATA ENTRY] controls to see this

ALG1 110000 OP1
L KEY SCALE = -LIN

- Set the depth of the left curve (the slope at which the sound will roll off below the break point). Do so by pressing [DEPTH] and observing the display which will either indicate the LEFT or RIGHT depth; if necessary press the button a second time to ensure that the LEFT depth setting is displayed. Then push up [DATA ENTRY] to obtain a maximum depth setting of 99.

Then press this to see the RIGHT depth

DEPTH	25	O
RANGE BREATH CON		

And adjust the [DATA ENTRY] controls to see this

ALG1 110000 OP1
R SCALE DEPTH = 80

Press this once or twice

DEPTH	25	O
RANGE		

And adjust the [DATA ENTRY] controls to see this

ALG1 110000 OP1
L SCALE DEPTH = 99

Now play some scales and notice how the sound "goes away" as you move down the keyboard. While the break point is set at E4, you probably won't hear the sound getting quieter until you get to C4. By the time you reach middle C, however, the level is down about 22 dB. That's about 1/14 as loud. As you move down the keyboard, the sound disappears. This is an extreme example of level scaling, and a useful one as you will hear. Lets leave the lower portion of the keyboard "rolled off" for now.

- As you play the highest notes on the keyboard, you may find the sound to be unnaturally loud. In order to scale this portion of the sound, you can set the right curve and depth as follows:

Press the [CURVE] button to see what curve is set for the right side, and adjust [DATA ENTRY], if necessary to obtain a (-) exponential curve. Then press [DEPTH] once or twice to see the RIGHT scaling value and adjust [DATA ENTRY] to get a value of 80.

Press this to see the RIGHT scale

And adjust the [DATA ENTRY] controls to see this

CURVE	24	N
EG BIAS		

ALG1 110000 OP1
R KEY SCALE = -EXP

Now play up the scale from E4 and hear how you have removed just a bit of volume from the highest notes.

*NOTE In the examples just given, the keyboard level scaling may seem to have an effect mostly at the higher number values, but that's because you were adjusting a carrier. Modulator levels tend to be more critical, and you'll hear a greater difference in some voices than others, depending on the algorithm, the particular location of the modulator within the "stack", and the actual output level setting of the operator. Remember, also, that if you are "boosting" the level with a positive (+) linear or exponential curve, you have to begin with an Operator Output Level that is less than 99; the lower the Operator Output Level setting, the more range available for Keyboard Level Scaling boost.*

- Press [OPERATOR SELECT], then use the KEYBOARD LEVEL SCALING buttons and [DATA ENTRY] to set operator 2 to a [BREAK POINT] of E4 with a "LIN" left [CURVE] and a left [DEPTH] of 99.

### LFO Modulation: The relationship between the "LFO" settings and the "MOD SENSITIVITY" settings, and how to program these

The LFO section enables you to set the waveform [WAVE] and frequency [SPEED] of a sub-audible oscillator. The LFO section has a button [PMD] that permits you to preset the voice so a portion of that modulation is applied to change the pitch of the voice (for anything from vibrato-like effects to exaggerated, continuous pitch bending). Simultaneously or instead, the same LFO wave can be assigned to modulate the amplitude (level) of each operator by using the [AMD] button. Amplitude modulation can produce tremolo when applied to a carrier, or "wah-wah" effects when applied to a modulator — among other effects.

LFO		SPEED		DELAY		PMD		AMD		SYNC	
WAVE											
9	9	10	0	11	A	12	B	13	C	14	D
EDIT RECALL VOICE INIT											BATTERY CHECK

A critical concept to grasp is that the modulation you select with these LFO buttons does not go directly to the operators. It does not necessarily do what you've set it to do unless you "open the gates" for the amplitude and/or pitch modulation output of the LFO to get to the operators.- These "gates" are the Modulation Sensitivity adjust-

LFO SECTION BLOCK DIAGRAM

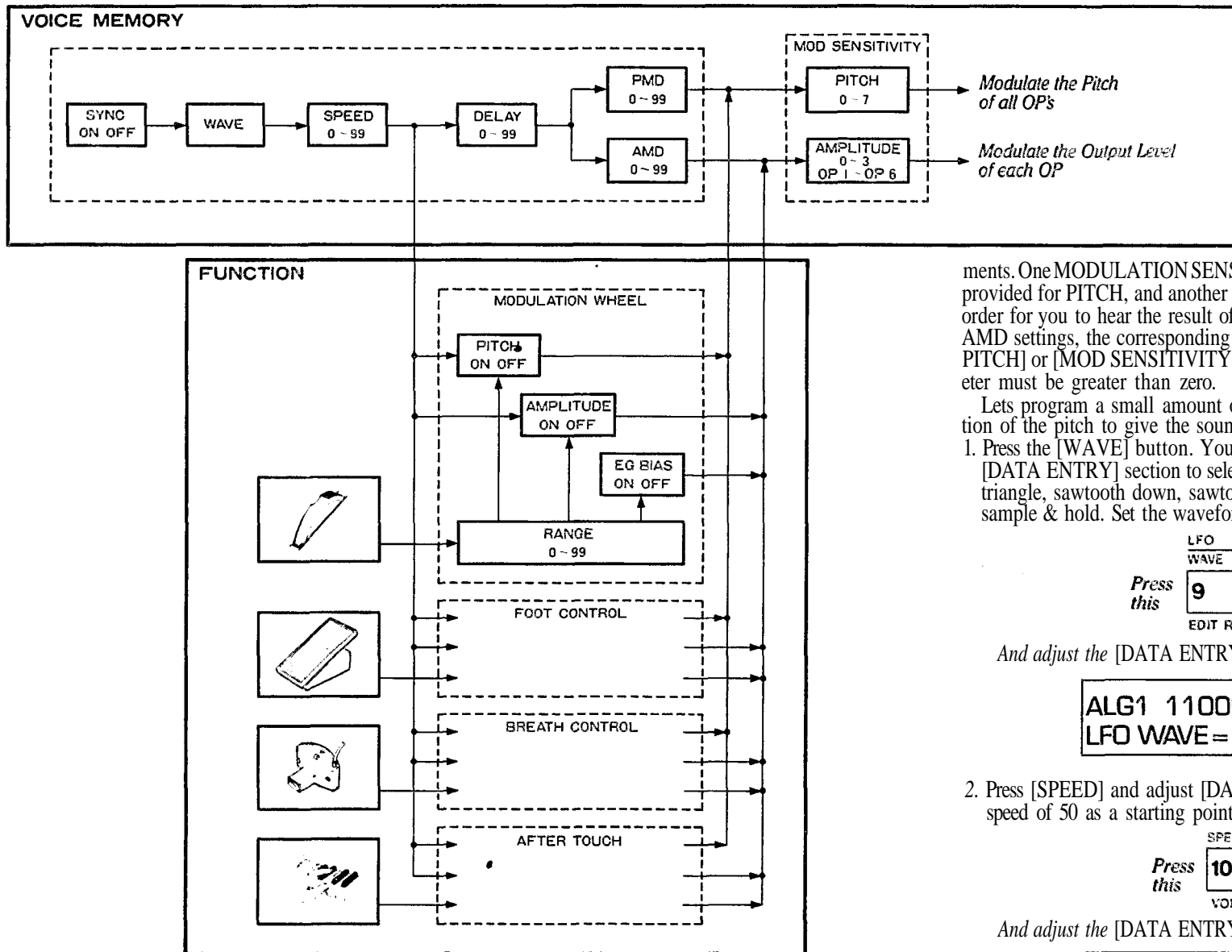

ments. One MODULATION SENSITIVITY control is provided for PITCH, and another for AMPLITUDE. In order for you to hear the result of any LFO PMD or AMD settings, the corresponding [MOD SENSITIVITY-PITCH] or [MOD SENSITIVITY-AMPLITUDE] parameter must be greater than zero.

Lets program a small amount of sine wave modulation of the pitch to give the sound some "character"  
 1. Press the [WAVE] button. You can now use the [DATA ENTRY] section to select any of 6 waveforms. triangle, sawtooth down, sawtooth up, square, sine, or sample & hold. Set the waveform to SINE.

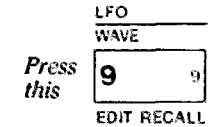

And adjust the [DATA ENTRY] controls to see this

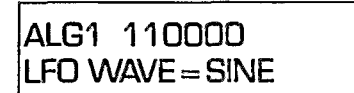

2. Press [SPEED] and adjust [DATA ENTRY] for a speed of 50 as a starting point.

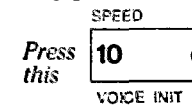

And adjust the [DATA ENTRY] controls to see this

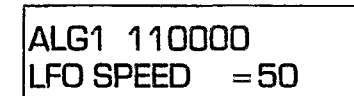

3. Press [PMD] (Pitch Modulation Depth), and adjust [DATA ENTRY] for a value of 50, again, just to begin. Now play a few notes. You probably won't hear any change from when you started... even with [PMD] set at the maximum of 99! That's because while the LFO is now generating a reasonably fast (SPEED = 50) waveform (SINE) at a high intensity (DEPTH = 50) for use by the pitch modulation circuitry the "gate" is still closed to the frequency shifting inputs of the operators.

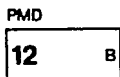
Press this 

And adjust the [DATA ENTRY] controls to see this

ALG1 110000  
LFO PM DEPTH = 50

4. Press [MOD SENSITIVITY PITCH], and now slowly raise the PMod Sensitivity value using the [DATA ENTRY] controls as you play a note. As the sensitivity value ranges from 0 (none or "closed gate") to 7 (maximum), the sound can quickly become weird. Leave the [MOD SENSITIVITY- PITCH] set at the lowest value that still gives you a noticeable effect, which is a value of about 2.

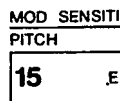
Press this   
SAVE  
CARTRIDGE

Try all values of [DATA ENTRY] while playing, then set at 2

ALG1 110000  
P MOD SENS. = 2

5. This is probably giving you far *too much pitch modulation*, but if you reduce the sensitivity further, there may not be enough sensitivity for modulation from other controls (like the after touch, breath controller, etc.). Therefore, leave the sensitivity set at 2, and instead lower the Pitch Modulation Depth in the LFO section. Press [PMD] and then adjust the value to 15.

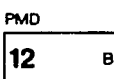
Press this 

And adjust the [DATA ENTRY] controls to see this

ALG1 110000  
LFO PM DEPTH = 15

6. This is an improvement, assuming you're attempting to program a clarinet-like voice (we are for now), but the modulation is still much *too fast* to be natural. Press [SPEED] and then adjust the LFO speed to a more natural-sounding frequency... a value of 27 should be about right. Play a few notes and see how it sounds.

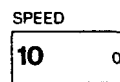
Press this   
VOICE INIT

And adjust the [DATA ENTRY] controls to see this

ALG1 110000  
LFO SPEED = 27

7. You have now set the LFO section to automatically add a small amount of vibrato to the voice, simulating the natural vibrato in a reed instrument. However, the effect is there all the time, whereas in a "real" instrument the vibrato might begin a short time after the note first becomes audible. This delayed onset of LFO modulation is available in the DX7 by using the LFO [DELAY] button; press it and set the delay value to 75 with the [DATA ENTRY] controls. Now play, a few notes and listen after you press a key to the elapsed time before the vibrato commences. This is probably a bit *too much delay* so readjust it to a value of 55 for now.

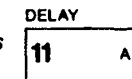
Press this 

And adjust the [DATA ENTRY] controls to see this

ALG1 110000  
LFO DELAY = 55

8. There are several additional, related controls we have not yet explored: [SYNC] and [AMD] in the LFO section, and [MOD SENSITIVITY-AMPLITUDE]. Lets begin with the [SYNC] function.

[SYNC] lets you use [DATA ENTRY] to turn LFO Key Synchronization ON or OFF. When Sync is ON, the LFO wave form starts at the beginning of its cycle each time you play a note. When Sync is OFF the LFO just keeps running, and each note you play "catches" the modulating waveform wherever it happens to be in its cycle. This effect is difficult to hear at the moderate LFO speed and depth you have programmed, so let's temporarily increase the depth and slow down the speed.

*NOTE* By now you should know how to set [SPEED], [DELAY], [PMD] and [MOD SENSITIVITY-PITCH] so TEMPORARILY change these values. Set a Speed of 3, a Delay of 0, a Depth of 99 and a Pitch Mod Sensitivity of 7. This "swooping" may sound strange, but bear with us.

Temporarily reset these values as shown

ALG1 110000  
LFO SPEED = 3

ALG1 110000  
LFO DELAY = 0

ALG1 110000  
LFO PM DEPTH = 99

ALG1 110000  
P MOD SENS. = 7

9. Press the LFO [SYNC] button and observe the display. The Sync should be ON. Play a note and hold the key down long enough to hear the modulation "swing" as the LFO waveform repeats. Then play the same note several times, holding the key down for a very brief time, and hear how each note starts changing pitch from the same initial frequency.

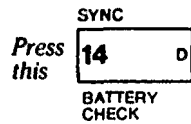

The display should look like this. Play several brief notes

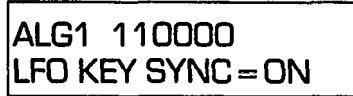

- Now use [DATA ENTRY] to turn the sync OFF. Again, play the same brief note several times, and listen to the pitch each time. You'll hear the initial pitch of each note change slightly as the randomly timed notes interact with the regularly oscillating LFO. With less exaggerated settings, leaving the LFO Sync OFF will cause minor changes from note to note that result in a more natural simulation of an acoustic instrument.

Then adjust [DATA ENTRY] so the display looks like this, and again play several brief notes

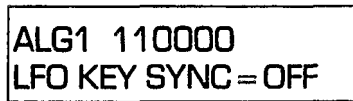

The two amplitude modulation functions, LFO [AMD] and [MOD SENSITIVITY-AMPLITUDE], work similarly to the pitch modulation depth and sensitivity, except that the amplitude sensitivity can be programmed separately for each operator. The SAX-BC1 voice in the Master Group is a good example of the use of LFO amplitude modulation, where the breath controller can be used to change the level of several operators.

To see how the amplitude modulation works, let's turn off the pitch modulation temporarily and turn on the amplitude modulation.

- Turn LFO Sync ON again by pressing [SYNC] and the [ON] button. Then set the pitch modulation depth at 0 by pressing [PMD] and pulling down the [DATA ENTRY] slider.
- Press [AMD] and bring the amplitude modulation depth up to a high value (from 50 to 99), and play a note on the upper section of the keyboard. (Remember that the Keyboard Level Scaling has "rolled off" this sound on the lower part of the keyboard). Notice there is no amplitude modulation yet. You need to

"open the gate" for each operator that you want the modulation to affect.

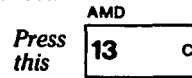

And adjust the [DATA ENTRY] controls to see this



- Press [MOD SENSITIVITY-AMPLITUDE] and then press [OPERATOR SELECT] to set Operator 2 as the current operator. Then use [DATA ENTRY] to bring up the sensitivity to a maximum of 3. Play a note, and listen to the timbre change. This modulation will be very pronounced, so you'll probably want to lower the sensitivity to about 1. The timbre changes because the LFO is modulating the modulator which produces the harmonics.

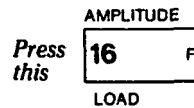

And the display should look like this

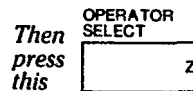
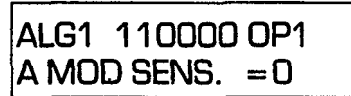

to select OP2, and adjust [DATA ENTRY] to 3 first, then to 1

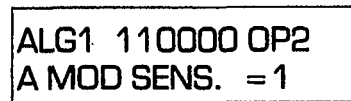

Now let's see what happens when you modulate the carrier's level.

- Press [OPERATOR SELECT] as needed to select operator 1, and then adjust its amplitude sensitivity to the maximum (3). Play a note in the upper part of the keyboard, and hear the wide deviations in volume. The wide deviations in volume occur because the LFO is being applied to change the output level

of the carrier through which all the sound in the stack must travel. Now reduce the sensitivity to 1.

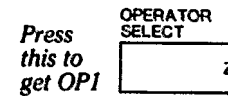

and adjust [DATA ENTRY] to maximum (3) then (1)

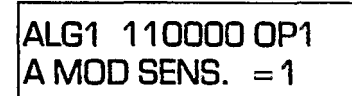

- The amount of amplitude modulation is probably still much too high, but we may want some amplitude modulation SENSITIVITY for use by an external modulation source (like the wheel or breath controller). Therefore, leave the sensitivity settings alone. Instead, press [AMD] and use [DATA ENTRY] to bring the amplitude modulation depth down to about 10 (very little depth compared to the maximum of 99).

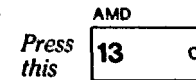

And adjust the [DATA ENTRY] controls to see this

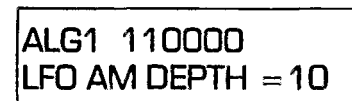

- Add some pitch modulation depth (it should be at zero) to obtain a pleasing frequency variation for some interest. Press [PMD] and set it to 15. Then press [DELAY] and set it to 55, press [SYNC] and turn off the key sync, and press [SPEED] and reset it to 27.

Now reset all these parameters for a more natural sound

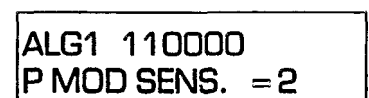
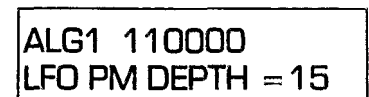
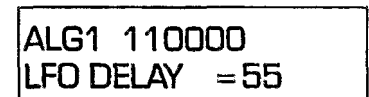
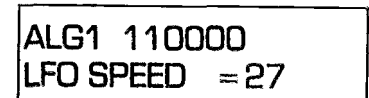



## Programming the remaining 4 operator\*

So far we have used just 2 of the 6 available operators within the algorithm to create the voice you are hearing. The remaining 4 operators can be used to add to the voice and richen it. However, for the purpose of demonstration, we'll show you how to program a completely different sound with them. Then, by using Keyboard Level Scaling, you can roll off this second voice in the upper part of the keyboard so you end up with a split keyboard.

*NOTE In this part of the manual, we'll assume you are beginning to gain some familiarity with the DX7, so we won't use quite as many illustrations, nor will we always instruct you to use [DATA ENTRY] to alter a value if it should be obvious that that's how the value is changed. If we say "adjust the frequency ratio to 3.00" we'll assume that you know how to push the slider or use the [-1] and [+1] buttons.*

This segment of the voice will become a piano-like sound. Remember that this is not supposed to be a "great" sound, just one for learning. In fact, we're eager for you to experiment with the voice after you create it so you can make improvements.

1. Press [OSCILLATOR-FREQUENCY COARSE].  
Turn ON operators 3, 4, 5 and 6, then turn OFF operators 1 and 2 by pressing the corresponding [OPERATOR ON-OFF] buttons.

*The display will show*

```
ALG1 001111 OP3
F COARSE = 1.00
```

Note that the current operator automatically changes to operator 3 (OP3) when you turn off the first two operators.

2. Change the frequency of operator 3 to a ratio of 2.00. Then press [OPERATOR SELECT] and adjust the frequency of each remaining operator as follows:

OPERATOR	FREQUENCY
3	2.00
4	2.00
5	12.00
6	4.00

3. You won't hear anything yet because those operator output levels are still set at the initialized value (zero). Reset the levels as indicated below; first press [OPERATOR OUTPUT LEVEL], and adjust the level of the current operator. Then press [OPERATOR SELECT], and set the output level for the next operator, and so forth.

OPERATOR	OUTPUT LEVEL
3	93
4	93
5	70
6	75

Play a few notes and listen to the sound. The "square" envelopes can be altered, making a major improvement toward obtaining a sound like an electronic piano.

4. If necessary, press [OPERATOR SELECT] until operator 3 is current. Then press [EG RATE] and adjust [DATA ENTRY] for each of the 4 rates, setting them as shown in the following chart. Then press [EG LEVEL] and set the 4 levels for operator 3, also according to the chart.

### OPERATOR 3 EG SETTINGS

RATE 1 = 95	LEVEL 1 = 99
RATE 2 = 20	LEVEL 2 = 95
RATE 3 = 20	LEVEL 3 = 0
RATE 4 = 50	LEVEL 4 = 0

Play a few notes and observe how the sound now resembles a hammer strike. This effect occurs because you have a fast rate to maximum level (R1,L1) for the "hammer strike", followed by a slow fall to an intermediate decay level (R2,L2), which has the effect of "widening" the hammer strike and making less of a "click". There is no sustain level (L3=0) because a piano string will not sustain indefinitely. However, it will continue vibrating for a long time if you do not release the key so a very slow rate is set for the fall to Level 3 (Rate 3=20). If you release the piano key shortly after striking the note, the sound will fall rather quickly to zero due to the damper. For this reason, Rate 4 is set to a moderately fast rate of 50. Level 4 is, of course, zero so that the sound will eventually fall to silence.

5. You want to have a similar envelope for operator 4, although a few of the rates can be changed so that the harmonic structure changes at a different rate than the overall volume.

You could press [OPERATOR SELECT] to set operator 4 as the current operator, then press [EG RATE] and [EG LEVEL] 4 times each while using [DATA ENTRY] to set the desired values. There is an easier method, as you may recall; use the "EG COPY" function.

To copy the envelope FROM operator 3 to operator 4, first make sure that operator 3 is still set as the current operator. Then press the [STORE] button and hold it down while pressing the [4] button. This copies all rates and levels from operator 3 to operator 4.

There is one change to be made for operator 4 in that Rate 2 must be set at 29 instead of 20, where it had been for operator 3. Press [OPERATOR SELECT] to set operator 4 as current. Then press [EG RATE] until rate 2 appears in the display and adjust it with the DATA ENTRY [+1] button. The envelopes for operators 3 and 4 now complement one another. The settings are shown below for operator 4:

### OPERATOR 4 EG SETTINGS

RATE 1 = 95	LEVEL 1 = 99
RATE 2 = 29	LEVEL 2 = 95
RATE 3 = 20	LEVEL 3 = 0
RATE 4 = 50	LEVEL 4 = 0

6. The envelope for operator 6 will be set identically to that of operator 4. Since OP4 is still set as the current operator, just press and hold [STORE] and then press [6] to copy the envelope from OP4 to OP6.
7. Similarly the envelope from operator 3 can be copied to operator 5. Do so by pressing [OPERATOR SELECT] until OP3 is current. Then press down the [STORE] button and hold it while pressing [5] to copy the envelope to OP5.
8. Play a few notes, and observe how the sound has improved, with much more of an electric piano feel to it. The "piano" sound now appears across the entire keyboard. Let's see what happens when the "clarinet" sound is again introduced.
9. Press the [OPERATOR ON-OFF] buttons [1] and [2] to turn on the clarinet-like sound. Now play from the bottom of the keyboard to the top. Notice how there is only piano sound on the bottom, and how the clarinet enters in the top half of the keyboard due to the previous keyboard level scaling of operators 1 and 2.

In this case, we do not want these two segments of the voice (OP1-OP2 and OP3-OP6) to combine; we want a "split" keyboard instead. (With another voice, you might want the two voice segments to play together, complementing one another.) Since we don't want the piano mixed with the clarinet, let's use the keyboard level scaling feature to "roll off" the piano (OP3-OP6).

10. If necessary press [OPERATOR SELECT] to set operator 3 as current. Then press [BREAK POINT] and use [DATA ENTRY] to set the break point as shown below. Next press [OPERATOR SELECT] to set operator 4 as current, and set its break point as indicated in the chart. Operators 5 and 6 will not need any level scaling because their effects will be adequately contoured by operator 4 (through which both must travel).

<u>OPERATOR</u>	<u>BREAKPOINT</u>
3	A2
4	C3
5	(Doesn't matter)
6	(Doesn't matter)

11. Now that the break points are set, you'll need to establish the curves for each of these operators. Press [CURVE] and use [DATA ENTRY] to set operator 4 to a negative linear curve on the right side of the break point. Remember you may have to press [CURVE] *once or twice* to see the "R CURVE = ?" display
12. Set operator 3 as the current operator, and then use [DATA ENTRY] to set it to a -LIN Right curve.
13. Now set the depth of the right curves for operator 3 by pressing [DEPTH] once, to see the "R DEPTH = ?" display and adjusting [DATA ENTRY] to a value of 99 (maximum roll off). Press [OPERATOR SELECT] to set operator 4 as current, and set its depth to 99 also.

You can now play the keyboard and observe how the sound changes from the piano-like voice on the bottom to the clarinet-like voice at the top. It's all one voice, but the component "stacks" of carriers and modulators are uniquely programmed and scaled to produce two distinct sounds.

14. To obtain a slightly altered harmonic structure, you may want to shift the pitch just a little bit for operator 4, the primary modulator in the piano portion of the voice. You can do this by pressing [DETUNE]

and adjusting [DATA ENTRY] to suit your taste while playing the piano-like sound on the lower portion of the keyboard. We recommend starting with a Detune value of +3 for OP4.

15. The entire keyboard can be transposed if you like. Press the [KEY TRANSPOSE] button and then press the key which you want middle C to become. Now play and see what happens. If you want to transpose again, press [KEY TRANSPOSE] again and press the new "middle C" key This transposes both portions of the voice.

Suppose, however, that you just want to transpose the piano portion of the voice. To do this, you do not use the transpose feature. Instead, you change the frequency ratios of the operators in that part of the voice (operators 3, 4, 5 & 6).

16. Press [OPERATOR SELECT] as many times as needed to set operator 3 as current. Then press [OSCILLATOR FREQUENCY COARSE] and you'll see the ratio is now set at 2.00. To transpose an octave, double this ratio to 4.00. At this point, the voice will seem to "change" because the modulator frequencies have not yet been transposed, so the modulation will, in fact, be producing a different effect.
17. To "correct" and completely transpose the piano-like sound, double the frequency ratio of each of operators 4, 5 and 6 by pressing [OPERATOR SELECT] and adjusting [DATA ENTRY]. Operator 4 increases from 2.00 to 4.00, operator 5 from 12.00 to 24.00, and operator 6 from 4.00 to 8.00. Now play across the keyboard and listen to what has happened... two lead voices!

### Programming velocity sensitivity

The output level of each operator can be programmed to increase based on how rapidly a key is pressed down. This is accomplished with the [KEY VELOCITY SENSITIVITY] button. Since the maximum output level of any operator is always 99, if an operator is already set to 99, it might seem that no further output can be achieved using the velocity sensitivity. To get around this problem, the DX7 is designed so that the nominal operator output level decreases as you program the operator for more key velocity sensitivity. If an operator is programmed for maximum key velocity sensitivity (7), and you play a note very slowly, that operator will have a very low output level; play the same note quickly, and the output level will increase substantially

To illustrate this feature, lets program the piano-like portion of the voice to get louder and more brilliant when you press the keys faster. We'll do something similar with the clarinet-like portion of the voice. (We'd say "play harder," which is what we mean, but we don't want to confuse this parameter with the After Touch modulation that depends on the pressure you apply after the key "bottoms out.")

1. Press [KEY VELOCITY SENSITIVITY] and then press [OPERATOR SELECT] as required to set operator 1 as the current operator.

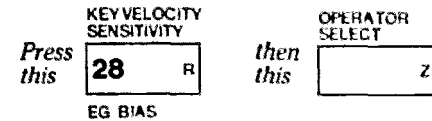

and use [DATA ENTRY] to set OPI like this

```
ALG1 111111 OP1
KEY VELOCITY = 3
```

2. Then press [OPERATOR SELECT] and use [DATA ENTRY] to set each of the other operators' for key velocity sensitivities as shown in the accompanying chart.

<u>KEY VELOCITY SENSITIVITY</u>	
<u>OPERATOR</u>	<u>VALUE</u>
1	3
2	0
3	2
4	7
5	7
6	7

3. The resulting voice will change as you press keys faster. If you experiment with different velocity sensitivity values, you may find that no combination is "ideal." It may be necessary to go back and change the operator output level settings,

### Naming and storing the newly created voice

1. Now that you've created the voice, perhaps you'd like to give it a name all of your own. Press [VOICE NAME] and you'll see a blinking cursor (a box) appear at the starting position of the 10 available character spaces for the name. To actually enter a name,

press and hold down the [CHARACTER] button, then press individual buttons which correspond to the letters, numbers, or punctuation you wish to use.

You can determine which buttons produce which alphanumeric characters by looking at the small dark brown "reversed" type in the right corner of each button. If you want to correct a character, continue holding [CHARACTER] and use the DATA ENTRY [<] or [>] buttons to move the cursor to the position you want to change. Then re-enter the new character (or press [SPACE] to leave a blank space).

2. Now that the voice is reasonably complete, you may wish to store it on a RAM cartridge, or to store it in an internal memory. If you're going to use the RAM cartridge, make sure its On-Off slide switch is set to OFF so that the memory is not protected. You will then have to turn off the software memory protection in the DX7 for the cartridge or internal memories by pressing the corresponding [MEMORY PROTECT] button and then pressing the [OFF] DATA ENTRY button. The memory is now ready to accept the voice.
3. Press the [MEMORY SELECT-INTERNAL] or [MEMORY SELECT-CARTRIDGE] button, depending on where you want to store the voice, then press and hold down the [STORE] button. While holding [STORE], press the voice selector button corresponding to the specific location (1-32) in which you want to place the voice.

That's it. The voice is now stored.

*NOTE* If you accidentally press a voice selector button without holding down the [STORE] button, you will lose the voice you have just created and will, instead, hear the newly selected internal or cartridge voice. *HAVE NO FEAR*, you can recover the "lost" voice by using the following "EDIT RECALL" procedure:

### **Edit Recall "Emergency Voice Recovery" Instructions**

- a) Press the [FUNCTION] button to place the DX7 in FUNCTION mode.
- b) Press the [EDIT RECALL] button, then press the [DATA ENTRY] [YES] button to answer the two prompts "edit recall?" and "are you sure?".
- c) You have now recovered the "lost" voice; repeat step 3 to store the voice.

4. The voice is stored, but it is also still in the edit/play buffer memory where you can continue to experiment with it. For example, press [EDIT/COMPARE] to return to the editing mode, and then try adjusting some parameters. One change we recommend is to try the different algorithms. Press [ALGORITHM SELECT] and then change from algorithm #1 to #9. Notice the improvement in the piano portion of the voice (at least we think it's an improvement), and the change in the clarinet side of the voice.

Try all the algorithms to hear the differences they make in the sound. You may want to experiment with different EG settings, keyboard rate scaling, and so forth. If you stumble across something you want to keep, rename it and store it in another memory location.

5. When you're done with your editing session, press whichever [MEMORY PROTECT] button you had originally pressed to turn off the protection (cartridge or internal), and use the [DATA ENTRY-ON] button to restore protection so you or someone else cannot accidentally erase any voices. If the RAM cartridge is where you saved the voice, also remember to turn on its hardware memory protect switch once again.

That covers just about all the basic programming functions of the DX7. If you've mastered this information, you're ready to create any voice you wish. It may take a bit of practice, but soon the instrument can become an "intuitive" extension of your creative mind.

*Hint* If you're playing on stage, either presets or voices you've programmed on RAM, you may want to ID these voices by applying a length of white masking tape (appropriate width) to the front panel and writing the voice names next to the voice selector buttons.

Any of the preset voices can be edited to change them slightly, or totally. In fact, the term "primary voice" might be better than "preset voice," since these voices are not permanent like the presets of most other synthesizers. In fact, all DX7 presets are completely programmable. So, too, are any voices you may have created from scratch or copied from another DX synthesizer.

A special EDIT mode is provided for editing the voices, preset or personally programmed. We'll provide a brief example of editing a preset voice, and you'll see that the process is almost identical to that of programming from scratch, as previously detailed.

1. Select the Electric Piano 1 voice from the Master Group of the DX7 voice ROM cartridge. Play the voice. Lets suppose you want to change the timbre of the sound so it becomes more penetrating... but not alter any of the envelopes, fundamental pitches, modulation, or touch sensitivity.

*The display should look like this*

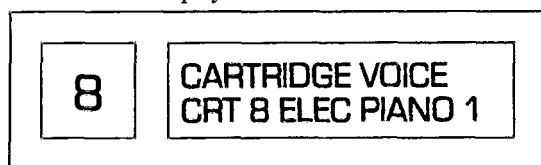

2. Press the [EDIT/COMPARE] button, and notice that the display changes to show the last programming function which had been used. If you've been going straight through the manual, that function would be "algorithm select," though it is not important really

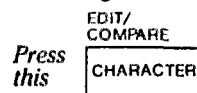

*And see this*

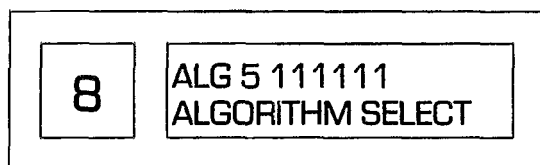

3. From the diagram for algorithm 5 (which the display tells us is the algorithm of this voice), we see that operator 2 is the modulator of one stack, and therefore increasing its output level may "brighten" the voice. We won't know for sure until we try it. Press

[OPERATOR OUTPUT LEVEL] and then press [OPERATOR SELECT] until operator 2 is set as the current operator.

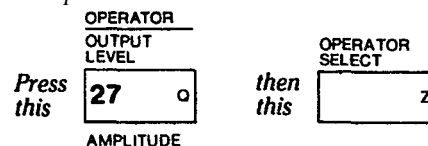

*to see this*

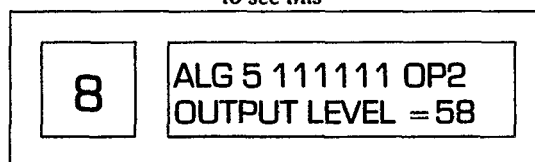

So far, the only clue you have that you are in the Edit mode is that the LCD display shows editing functions such as "Algorithm Select" and "Output Level." You are about to see that another aspect of the display can show you whether anything has yet been changed. (So far, you have not actually changed the voice.)

4. Play a few notes, varying the velocity with which you press the keys. Then move the [DATA ENTRY] slider to change the output level of operator 2 to 90. Notice that the instant you change this parameter, a decimal point appears to the right of the voice number in the LED display. This decimal is your clue that the voice is no longer the same as the preset. Play a few notes and hear for yourself.

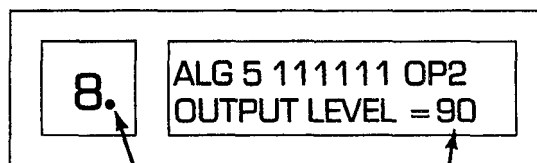

*Notice this decimal point appears*

*when the output level changes*

5. If you want to compare the newly edited sound to the original sound, you can press the [EDIT/COMPARE] button once. Notice the decimal point in the LED voice number display disappears, and the number itself begins to flash. While the number is flashing, you can play the original, unedited voice. Press [EDIT/COMPARE] again and the edited voice reappears, decimal point and all.

You can see that this is exactly the same way you use the controls to create a voice "from scratch" using the [VOICE INIT] function. In fact, [VOICE INIT] really does nothing more than to set all parameters to a default value, and then places the DX7 in the EDIT mode. If you want to change any other parameters, just press the appropriate selector button(s) and use [DATA ENTRY] or any other buttons required to program the new values. We strongly recommend that you rename an edited voice by using the [VOICE NAME] function.

6. If you wish to save the edited voice, you have several choices. If you have edited a preset ROM voice, you cannot save that voice on a ROM... ROMs are Read Only Memories. You can, however, save the edited preset on a RAM (Random Access Memory) cartridge or in an internal memory within the DX7. If the "original" voice you edited was selected from a RAM or an internal memory, you can over-store the edited voice in the same place, or in a different memory location so you retain the original and edited versions. The method of storing the edited voice is identical to that for storing a voice you created "from scratch"; we repeat this below for convenience.
7. You can store the edited voice on a RAM cartridge, or store it in an internal memory. If you're going to use the RAM cartridge, make sure its On-Off slide switch is set to OFF so that the memory is not protected. You will then have to turn off the software memory protection in the DX7 for the cartridge or internal memories by pressing the corresponding [MEMORY PROTECT] button and then pressing the [OFF] DATA ENTRY button. The memory is now ready to accept the voice.
8. Press the [MEMORY SELECT-INTERNAL] or [MEMORY SELECT-CARTRIDGE] button, depending on where you want to store the voice, then press and hold down the [STORE] button. While holding [STORE], press the voice selector button corresponding to the specific location (1-32) in which you want to place the voice. If this is the same location where the original voice was located, the edited voice will erase (and replace) the original. The moment you store the voice, the decimal point in the LED voice number window disappears, and you are out of the EDIT mode.

**Analyzing and keeping a record of voices**

You can use the EDIT mode to examine all the parameters of each preset... or of any voice. You don't have to change anything, but the envelope or frequency ratios or touch sensitivity of a voice may be useful to you in creating a new voice. In the event a voice is accidentally erased, the written record can be used to guide you in reprogramming the voice. We recommend using the handy form provided on the inside of the back cover of this manual (unrestricted permission is hereby granted for you to reproduce as many of the DX7 Voice Data List

forms as you wish). The accompanying form has been filled out as you might do it to describe the voice created in the Tutorial section of this manual.

In fact, we recommend using the EDIT mode to analyze and record the parameters of several preset voices strictly as a learning tool for you. Play the voices, look at the way the voice is programmed, and try to understand how the settings affect the sound and touch of the voice.

Here's a hint on how to make useful edits on complex voices without excessive analysis or trial-and-error. Select a voice such as a flute, french horn, piano, etc. Then press [EDIT/COMPARE], and press [OSCILLA-

TOR FREQUENCY-COARSE]. Finally press [OPERATOR SELECT] repeatedly and examine the frequency ratios for the 6 operators. With most voices, you'll see a lot of 1.00 and 2.00 ratios, but mixed in with these there may be one ratio which is unusual, a fine-tuned ratio like 1.53, or a very high ratio like 24.00. If you then adjust the [OUTPUT LEVEL] of that "unusual" operator's frequency ratio, or change its frequency ratio with coarse or fine control, you can make interesting and useful changes to the character of the sound.



DX7 VOICE DATA LIST

DATE/PRESET No. : 9/25

VOICE NAME : LEARNING

PROGRAMMER : GARY

9	5	SINE	27	55	15	0	OFF	2	0	OP 6					
									0	5					
									0	4					
									0	3					
									9	2					
									3	1					
ALGO-RITHM	FEED-BACK	WAVE	SPEED	DELAY	PMD	AMD	SYNC	PITCH	AMPLITUDE						
LFO							MOD. SENSITIVITY								
1	2	3	4	5	6	7	8	9	10	11	12	13	14	15	16

POLY/MONO	PITCH BEND		PORTAMENTO		
	RANGE	STEP	MODE	GLISS-ANDO	TIME
	POLY	12	0	RETAIN	OFF

OP	6	R	B.	00	0	95	29	20	59	95	0	0	—	—	—	0	0	0	75	7											
	5	R	24.	00	0	95	20	20	99	95	0	0	—	—	—	0	0	0	70	7											
	4	R ON	4.	00	+3	95	29	20	99	95	0	0	C3	-	LIN	0	99	0	93	7											
	3	R ON	4.	00	0	95	20	20	99	95	0	0	A2	-	LIN-LIN	4	99	0	93	2											
	2	R	2.	00	0	43	99	99	50	99	99	0	E4	-	LIN	—	99	0	69	0								50	50	C3	LEARNING
	1	R	0.	50	0	43	99	99	50	99	99	0	E4	-	LIN-EX	99	80	4	99	3											
MODE/SYNC	FREQ. COARSE	FREQ. FINE	DETUNE	OSCILLATOR				EG				BREAK POINT	KEYBOARD LEVEL SCALING				K. BOARD RATE	OUTPUT LEVEL	VELOC. SENS.	PITCH EG				KEY TRANSPOSE	VOICE NAME						
				1	2	3	4	1	2	3	4		L	R	L	R				1	2	3	4								
MODULATION WHEEL				FOOT CONTROL				BREATH CONTROL				AFTER TOUCH																			
RANGE	PITCH	AMPLITUDE	EG BIAS	RANGE	PITCH	AMPLITUDE	EG BIAS	RANGE	PITCH	AMPLITUDE	EG BIAS	RANGE	PITCH	AMPLITUDE	EG BIAS	RANGE	PITCH	AMPLITUDE	EG BIAS												
50	ON	OFF	OFF	50	ON	OFF	OFF	50	ON	OFF	OFF	50	ON	OFF	OFF	50	ON	OFF	OFF												

## THE INTERNAL AND CARTRIDGE MEMORIES

We have already described how to play voices that are stored in the internal memories or cartridge memories. As part of the tutorial, we have also described how to store a single voice. The following instructions provide additional detail on the use of these memories for storing and rearranging voices. To remain consistent with the panel labels on the DX7, we use the term "Store" to describe the process of placing the currently selected voice (the one which is being played or edited) into any location (1-32) in the internal or cartridge memories. We use the term "Save" to describe the process of simultaneously placing all 32 internal memory voices into the correspondingly numbered cartridge memories. We use the term "Load" to describe the process of transferring the 32 voices from one bank of a ROM cartridge, or from a RAM cartridge, into the 32 internal memories.

### Memory Protect

When you store a voice (or voices) into an internal or cartridge memory, whatever voice had been in that memory location is automatically erased... just like recording new material over an old tape (although recording tape is not involved). To help you avoid the frustration and inconvenience of accidentally erasing any voices, the DX7 is equipped with several types of Memory Protection. The [MEMORY PROTECT] buttons provide independent "software" protection for the internal and cartridge memories. In addition, the RAM cartridges themselves have "hardware" memory protect switches. You can always "read" or "load" a voice from a memory regardless of memory protect status. However, you cannot store a voice in any internal memory (or load the RAM voices into the internal memories) unless the internal memory protect is first disabled (turned OFF). Similarly, you cannot store a voice in any internal memory (or save the 32 internal voices to RAM cartridge) unless the cartridge's hardware memory protect switch is OFF and the DX7's software memory protect-cartridge feature is also OFF.

The following instructions describe the procedure for turning the memory protect off; they also instruct you to turn ON the memory protect as soon as the voice(s) have been stored. It is a good idea to always turn ON the memory protect unless you specifically need to store a voice. This habit may someday avoid accidental erasure of your voices.

### Storing individual voices to RAM cartridge

1. First make sure the Memory Protect switch on the RAM cartridge is turned OFF (switch positioned away from the connector).
2. Whether you have been playing an internal voice, editing a voice, or creating one from scratch in the VOICE INIT mode, turn off the software memory protect. Press [MEMORY PROTECT-CARTRIDGE], and the display will indicate "MEMORY PROTECT CARTRIDGE ???". If "???" is "OFF", the software protection is already off and you can go directly to Step 3. If the "???" is "ON", then press the [OFF] button.
3. Press the [MEMORY SELECT-CARTRIDGE] button, and then press the [STORE] button and hold it down while pressing the voice selector button (1-32) which corresponds to the RAM cartridge memory in which you wish to store the voice. The LCD display will briefly indicate "Under Writing", and will then return to the voice name and number, indicating the voice has been stored.

*NOTE: If you attempt this step with either the software or hardware cartridge memory protection ON, the display will indicate "MEMORY PROTECTED" as soon as you press [STORE]. If, when you release [STORE], the voice name reappears, then the software memory protect is ON; perform Step 2 as above, then Step 3 again. If, when you release [STORE], the "MEMORY PROTECTED" message remains displayed, the hardware protect is ON; perform Step 1, then Step 3 again.*

4. Once the voice is stored, press [MEMORY PROTECT-CARTRIDGE] and [YES] to reactivate the software memory protection, and then reset the switch on the RAM cartridge to reactivate its hardware memory protection.

### Saving all 32 internal memory voices to RAM cartridge

1. First make sure the Memory Protect switch on the cartridge is turned OFF (switch positioned away from the connector). Then turn off the software memory protect by pressing [MEMORY PROTECT-CARTRIDGE] followed by [OFF].
2. Press [FUNCTION] to place the DX7 in FUNCTION mode, and then press [SAVE]. When the display asks "SAVE MEMORY ALL OF MEMORY?", press [YES] (unless you change your mind, in which case you should press [NO] and go on to whatever function

you wish).

3. Because you are about to erase whatever voices are in the RAM cartridge, the DX7 gives you one more opportunity to change your mind by asking "SAVE MEMORY, ARE YOU SURE?" If you indeed want to save the 32 internal voices in the RAM cartridge, press [YES] this second time (if not, press [NO]).
4. The display will indicate "SAVE MEMORY, UNDER WRITING!" for about 20 seconds as the voices are being written (saved) onto the cartridge. The display will then indicate "SAVE MEMORY COMPLETED", at which point you can select whatever mode you wish.
5. Once the 32 voices are saved, press [MEMORY PROTECT-CARTRIDGE] and [YES] to reactivate the software memory protection, and then reset the switch on the RAM cartridge to reactivate its hardware memory protection.

### Loading all 32 ROM or RAM cartridge voices to internal memory

1. First turn off the internal memory protect. Press [MEMORY PROTECT-INTERNAL], and the display will indicate "MEMORY PROTECT INTERNAL ???". If "???" is "OFF", the internal memory protection is already off and you can go directly to Step 2. If the "???" is "ON", then press the [OFF] button.
2. Press [FUNCTION] to place the DX7 in FUNCTION mode, and then press [LOAD]. When the display asks "LOAD MEMORY ALL OF MEMORY?", press [YES] (unless you change your mind, in which case you should press [NO] and go on to whatever function you wish). Because you are about to erase whatever 32 voices are in the internal memory, the DX7 gives you one more opportunity to change your mind by asking "LOAD MEMORY, ARE YOU SURE?" If you indeed want to load the 32 RAM voices into the internal memory press [YES] this second time (if not, press [NO]). After a second or so, the message "LOAD MEMORY COMPLETED" appears, telling you the voices are loaded.
3. Once the 32 voices are loaded, press [MEMORY PROTECT-INTERNAL] and [YES] to reactivate the internal memory protection.

### Transferring a single voice from one location to another in the RAM cartridge or internal memory

You may wish to rearrange the voices so they fall in a particular order as, for example, when you are going to

play a live performance and you want memories 1-32 to contain the voices you plan to play in numerical order. This can be done either in the internal memory or in the RAM cartridge memory. Its best to have at least 1 "blank" or unwanted voice which you can erase when doing this. If you need all 32 voices, but simply in a different order, make a copy of them (either by saving from internal to RAM cartridge, or loading from RAM cartridge to internal, as appropriate).

1. Determine whether you want to work with the RAM cartridge or internal memory and turn off the corresponding software memory protection by pressing [MEMORY PROTECT-INTERNAL] or [MEMORY PROTECT-CARTRIDGE] and then pressing [OFF]. If you're working with the RAM cartridge, also be sure its hardware memory protect switch is OFF.
2. Select a voice you wish to move by pressing [MEMORY SELECT-INTERNAL] or [MEMORY SELECT-CARTRIDGE], and then the appropriate voice selector button, from [1] to [32].
- 3a. Assuming you want to move the voice into a different position within the same memory area (internal or RAM cartridge) from which you selected it, press and hold [STORE]. Then press the voice selector button corresponding to the memory location into which you wish to move the voice. THIS NEW LOCATION SHOULD BE BLANK, OR ONE YOU DONT MIND ERASING, UNLESS YOU HAVE ALREADY MADE A COPY OF ALL 32 VOICES AS DESCRIBED PREVIOUSLY.

The voice has now been stored in the new location. (It still exists in its original location.) Now you can release the [STORE] button, press the voice selector of the next voice you want to move, and then press [STORE] and the voice selector of the memory in which you wish to store this voice.

- 3b. If you want to move the voice into the same or a different position within the other memory area (i.e., from RAM cartridge memory 6 to internal memory 2), the procedure is similar. You have already pressed [MEMORY SELECT-CARTRIDGE] and [6] to select RAM cartridge voice number 6. To assign this to internal memory 2, press [MEMORY SELECT-INTERNAL], then press and hold [STORE] while you press voice selector [2]. (If you want to move from an internal location to a RAM cartridge location, substitute the opposite [MEMORY SELECT] buttons for those in this example.)

To move the next voice from a RAM cartridge to an internal location, repeat Step 2 and Step 3b.

4. The process can be continued, selecting a voice and moving it to a new location. As you can see, its like one of the puzzles where you have 15 numbered squares and 1 blank space, and you have to rearrange the squares in numerical order — you always have to use at least one memory location as the "blank" square so you can shuttle the others around. That's why we suggest making a copy of all 32 voices if you plan to move them around within the internal or cartridge memory. Once you've done most of the rearranging, you can go to the copied voices and transfer the "erased" voices back where you want them using the procedure in Step 3b above.
5. As always, when you have completed the operation, turn the memory protection back ON.

*NOTE: If a "FORMAT CONFLICT" "ID CONFLICT" or "READ PROTECT" message is displayed during a STORE or SAVE operation using a RAM cartridge, it means the cartridge must be formatted. For details, please refer to the CARTRIDGE FORMATTING section on page 9.*

## ADVANCED PROGRAMMING NOTES

### Playing style and programming of dynamic control

By now you should be familiar with some of the ways the DX7's keyboard can be programmed to be touch responsive. If you have read the programming instructions in this manual and tried to create or edit voices, you are probably aware of the wide range of sensitivity settings that are available to you. If not, you can still experience a good deal of this flexibility by playing the presets. Excellent preset examples can be found in the DX7 VOICE ROM #3 Master Group, including Electric Piano, and Jazz Guitar. Flexibility and variety in programming can be virtues, if used wisely. When it comes to programming the touch response of the instrument, there is more to consider than "how wide a range can I obtain?"

Consistency is a primary consideration. We speak of consistency in terms of your playing style, not the sound of the voice itself. Use your ears to determine how loud or bright a sound is created in relation to how forcefully you play the keyboard. If you strive to program your voices so the keyboard "plays" similarly the DX7 will take on a characteristic "feel." If you program each voice independently you may never become accustomed to the keyboard because it will behave like many different instruments. You'll make your job much easier if you program the DX7 to *sound* like many different instruments, but to *play* like one.

When you set out to create a voice that will have touch sensitivity (Keyboard Velocity Sensitivity and/or After Touch modulation sensitivity), we recommend that you work on it while playing and listening at moderate volume levels. Program the parameters for a mellow, almost pianissimo sound. Then, when you hit the keys hard, the voice will have "somewhere to go." Of course, you have to use some judgement because if you set things too low to begin with, you provide enough "head room" in the instrument so that a vigorous "fortissimo" chord could saturate a tape recording or damage a speaker system.

The Keyboard Level Scaling is also an important adjunct to dynamic playing style in that it can be used to change the output level when you play with the same touch at different areas of the keyboard. The human ear tends to be more sensitive to higher frequencies, and the DX7 normally creates equally intense sound across its entire keyboard so the net result is that higher notes can sound too loud or shrill. Therefore, it is often desirable to program a -EXP or -LIN curve on the right side of

the break point, and to use adequate scaling Depth to "smooth out" the response.

One approach to achieving consistency is to first find or create a few voices whose keyboard response you like. Then document the FUNCTION mode modulation settings as well as the EDIT mode's settings for LFO (speed, PMD and AMD), Modulation Sensitivity (amplitude and/or pitch), Keyboard Rate Scaling, and Keyboard Velocity Sensitivity settings. Then try to use settings in this same general range for most of your voices. Naturally there will be exceptions, but at least this will give you a framework which suits your own playing style and taste.

The envelope generator (EG) settings can also have a significant effect on the playing response of the keyboard. If the envelope attacks are slow and you're playing a staccato passage, the notes may not fully develop — or you may find yourself tending to slow your playing in order to hear the sound you want. In this case, it would be worthwhile to reprogram the attack rate, or to add some Keyboard Rate Scaling if the problem is primarily at the upper end of the keyboard.

All of the preceding suggestions may be completely inappropriate if you are using the DX7 for creating special effects. Then you may want odd level scaling, extreme touch sensitivity and so forth.

### Additional envelope considerations

Two notes can be sounded from a single keystroke (for double-tongued trumpet or mandolin like sounds) if the envelope is programmed as follows:

L1 = 99 (high)	R1 = 99 (fast)
L2 = 20 (low)	R2 = 35 (slow)
L3 = 95 (high)	R3 = 90 (fast)
L4 = 0 (off)	R4 = 50 (not critical)

The resulting envelope will have a rapid initial attack upon pressing the key. Then the sound begins falling to Level 2, which will sound like zero even if it is set as high as 30 or so. The sound then jumps rapidly to Level 3, at which it sustains as long as the key is held down. However, if you release the key as soon as Level 3 is attained, the sustain is truncated and you hear a "double attack" sound. If Level 2 is set at an intermediate point, say between 40 and 60, the double attack still works, but the effect is as though Rate 2 and Rate 3 were sped up. This apparent rate increase occurs because R2 doesn't have to fall to as low a level, and R3 doesn't have as far to climb, so the time is reduced.

You can simulate an ADSR if you set the envelope as follows: L1 = 99, L2 = 99, L4 = 0, and R2 = 99. With these settings, then R1 becomes Attack time, R3 is Decay time, L3 is Sustain level, and R4 is Release time.

To get the "whap" sound of brass, try using [VOICE INIT]. Then, from the initialized voice, leave OP1 as it is. Change from ALG 1 to ALG 2, change from Feedback = 0 to Feedback = 7, and then bring up the OP2 output level to 75. This produces the modulation you need for brass, but not the "whap." Reset OP2 EG Rate 1 from 99 to 70, which causes the modulation to "ramp up," rapidly increase the harmonics and produce the characteristic brass attack sound.

### Delayed turn-on using the envelopes

If you want the Operator attack to begin a while after you press the key, there are two approaches. One way is to set the first level (L1) to 99, and to set the attack rate to a low number (0 to 30). This will result in a gradual turn-on of the note, with almost no sound at first. If you want an abrupt (fast) attack, but you don't want it to start for a while after the key is pressed, you'll need to take a second approach. Set EG Level 1 to 0; R1 should be set to 99. Then set Level 2 to 0, and set Rate 2 to achieve whatever delay time you want. Be sure you press the key long enough while programming these delayed turn-on envelopes... it can take over a half a minute before you hear anything. Set Level 3 to 99 (or some reasonably high level), and set Rate 3 for whatever attack time you want on the note. Level 4 should be 0, and Rate 4 can be set to whatever release rate you desire.

### How to select an algorithm

There are 32 algorithms; all have the same 6 operators and one feedback loop, yet each algorithm is capable of creating sounds that the others cannot. Sometimes the differences between algorithms are negligible, yet at times the difference can be dramatic. It may help you to picture a voice as a the result of two interactive elements, (1) the algorithm, and (2) the frequencies and relative level of the operators within that algorithm.

An algorithm is nothing more or less than an arrangement of operators. Ultimately, there are just two ways that the operators can be connected: (1) side by side for additive synthesis, and (2) one on top of the other for frequency modulation. "Branching" where one operator feeds or is fed by two or three other operators, is just a



variation of the second category. Another variation similar to category (2) is feedback, which creates frequency modulation through regeneration.

If you were to set the 6 operators to any frequency ratios you choose, and set their envelopes and output levels to "typical" values (i.e., values like those found in several preset voices), you would find that changing the algorithm would change the sound very markedly. Notice that the 32 algorithms, as illustrated on the DX7 front panel, are sub-divided into 4 major groups (as shown by the boxes). While we are about to make a gross generalization, it can be useful in planning an approach to programming.

The most complex algorithms are at the upper left (1 through 6). These are examples of straight FM synthesis with two or three "stacks" of operators per algorithm. Many of the piano voices or orchestra voices are done with these algorithms because each stack can be programmed as though it were a separate voice within a voice (hence multiple strings on a piano note, or brass, bell and flute together).

A different type of complex algorithm appears in the upper right (7 through 18). These are useful for voices whose harmonic structure undergoes complex changes, yet with fewer different "sub voices" within a voice (bass, harp, and stringed instruments, for example). Of this category algorithms 7 through 15 include two carriers each, one of which has multiple stacks of modulators feeding it through two different carrier inputs (good for electric pianos as an example). Algorithms 16 through 18 also have branching, but they all have a single carrier whose three inputs are fed by different stacks of modulators (good for brass sounds, as an example).

Less complex still are the algorithms pictured at the lower left (19 through 25). Each includes one modulator which feeds 2 or more carriers, and the number of carriers form a progression: algorithms 19 and 20 each have 3 carriers, 21 to 23 each have 4 carriers, 25 and 26 each have 5 carriers. These are useful for sounds with more discrete attacks and less harmonic complexity — a pipe organ for example. Algorithms in the lower right (26 through 32) are arranged with a similar progression of 3, 4, 5 and 6 carriers, but these are the least complex algorithms in terms of the amount of modulation available. They are useful for such sounds as electric organs, simple wind instruments like a recorder, and so forth.

When you set out to create a given sound, you'll have to find the group of algorithms that you feel may be able to do the job; this judgement can be based on looking at

what algorithms the presets use, or by logical reasoning (after you learn a little more about programming the DX7.) Within a given group of algorithms, begin with the least complex algorithm that you feel will do the job — that is, the algorithm with the highest number. (We realize that decision, in itself, requires a reasonable amount of experience and insight... which should come more quickly if you follow our guidelines.) You may also find that it is sometimes possible to get precisely the same results with different algorithms — it depends on whether you're using feedback, and on the actual output level settings of each operator. At other times, two or more algorithms may at first seem to be the same, and as you refine the voice, you find that only one algorithm will do the job.

#### *Algorithm Selection Hints:*

*Two carriers, side by side, can be functionally equivalent to having two distinct sound sources that are simply added together. You can also program the two carriers with nearly the same parameters for a "richer" or "thicker" texture.*

*Regardless of the algorithm you select, use the fewest number of operators you can when you begin to program. Turn off the others while programming by using the [OPERATOR ON-OFF] buttons; if you want them to remain off after the voice is stored, turn their [OPERATOR OUTPUT LEVEL] to zero.*

### **Learn to program by studying how acoustic instruments work**

It is important to consider how an acoustic instrument creates sound, and to think about the relationship between particular "patches" on the DX to the method of sound generation in the acoustic instrument. For example, if you are trying to duplicate the sound of a piano, you would observe that many piano keys cause a hammer to strike two or three strings. Therefore, you might want to use an algorithm with two or three carrier/modulator stacks. Each stack can then be programmed to duplicate the sound of a different string, emulating the 2 or 3 strings struck by the hammer. There are other considerations, such as the sound of the hammer itself. You may program one stack to synthesize the sound of the felt striking the string(s), and then use the remaining stack(s) to create the string sound. The shifting harmonic structure of the acoustic piano note can be simulated by using different envelopes for each modulator. The inharmonicity (where harmonics are not in tune with the

fundamental) can be simulated by using the [DETUNE] function, and thereby changing the modulator frequencies to be slightly "off" from the perfect integer ratios. (Even though the frequency might still indicate something like "2.00", Detune causes it to be more like "2.001 or 1.998".)

If you're working on a bowed or plucked string sound, you can probably visualize the string being stretched initially then, as the vibration settles down, the note gets quieter. The initial stretch not only leads to a louder sound, it also raises the pitch, which then falls steadily toward the "normal" pitch of the note as the amplitude also falls. This effect can be simulated by using the Pitch Envelope. Set it for a slight increase in pitch initially (L1 slightly higher than 50), and then set the pitch of the rest of the voice to be "normal" (L2, L3 and L4 at 50). R1 should be at 99 so that the pitch initially starts at the higher frequency and then R2 can be set to a moderate rate so the pitch falls to normal at a rate resembling that of the plucked or bowed string. LFO pitch modulation can simulate vibrato, and so forth.

By following this logical approach, you should be able to figure out how to program more complex sounds with less guessing... or at least with more directed guessing. This is not to say that other methods are invalid or will not work — there are many ways to obtain a pleasing sound. Some piano voices, for example, can be achieved using Algorithm 19, which has just one carrier. The multiple stacks of modulators which all affect that carrier can be programmed to achieve the hammer strike and string sounds.

### **There is more than 1 way to create a pitch**

There are many ways to achieve a given pitch within a particular voice. At first, it may seem that the carrier frequency determines the fundamental pitch of the voice, and the modulator(s) affect primarily the harmonics or overtones. However, you will find this is not necessarily the case. For example, changing the carrier to a frequency ratio of 6.00 and the first modulator above it to a ratio of 2.00 can produce tones that have a fundamental pitch which is considerably lower than the 6.00 ratio would suggest. This is due to the strength of the sum and difference products of modulation — the so-called "sub harmonics" which are produced. When you are trying to get a particular sound, take the time to experiment with many different frequency ratios, not just the "obvious" choice. Moreover, be sure to try differ-

ent modulator output levels for each combination of frequencies, since this can make a world of difference in the sound.

### **Ensemble voices may differ from solo voices**

When a musician plays an instrument as part of an ensemble, whether 2 or 70 people are playing, the sound of his instrument will interact with the other sounds. There is a certain balance to be struck between blending with the other instruments, yet retaining a distinct identity. The need to retain an identity in the midst of this complex group texture (even if the "group" is nothing more than tape recorded Overdubs of the same DX synthesizer) calls for a more "penetrating" sound, sometimes one with more exaggerated LFO modulation or a slightly "edgy" harmonic structure. The same voice might sound too harsh or exaggerated in a solo performance. When you are programming a voice, be sure to evaluate it in the musical context where it will be used. You may want to program and store two variations of the same voice, one for ensemble and one for solo use. Some of the preset voices include the term "ensemble" (ENS) in their title; these voices often work better in an ensemble than as solo voices.

### **Breath controller applications and hints**

There are certain types of instruments that are difficult to phrase or articulate with a keyboard, such as brass or vocal sounds. The BC-1 breath controller may be used to phrase and shape the envelope or to add modulation of pitch and amplitude. The BC-1 is sensitive to pressure; the harder you blow into it, the more voltage it applies to the synthesizer's Breath Controller input. This voltage can be programmed to affect different aspects of the voice. The changes it brings about can be made very quickly — a great asset when performing. However, in order to use the breath controller, various parameters must be programmed into both the voice and the FUNCTION mode of the instrument.

To explore the use of the breath controller, select a voice which includes amplitude modulation sensitivity such as the "SAX-BC1" voice from the Master Group. Then plug in the Yamaha BC-1 breath controller.

#### **Amplitude modulation with the BC-1**

Press the [FUNCTION] button and then press [BREATH CONTROL-RANGE] and set the range to

50. Then press [BREATH CONTROLLER-AMPLITUDE] and turn it ON. Within the voice itself, the amplitude modulation sensitivity of one or more operators must be set to 1 or higher. In this case, the BC-1 may alter the volume, the timbre, or both depending on whether the AM sensitivity is turned up on the carriers) or modulator(s). Play the instrument and blow into the BC-1 to hear what happens.

*NOTE If you have to blow too hard while playing a voice which is known to be modulation sensitive, you may want to adjust the sensitivity of the BC-1 itself. Use a small slot-blade screwdriver to turn the recessed screw on the bottom of the unit. You can also cover up the small vent hole in the BC-1 with your finger or adhesive tape; this will increase the effectiveness of your breath, but will restrict the playing style somewhat (it also quiets the BC-1).*

#### **EG BIAS modulation with the BC-1**

When you turn up the EG bias (99 max), the actual level of each operator whose AM sensitivity is above 0 will go down. With a maximum AM sensitivity of 3, and EG BIAS of 99, the operator level will be zero. Then, when you blow hard into the BC-1, the level comes back up to the maximum level permitted by the envelope at any given instant; you must have played the note first on the keyboard so that the EG bias is bringing up the level within the programmed envelope. The rates of the envelope remain unchanged, but the sound will disappear instantly if the BC-1 is not blown.

For creating a voice like the "SAX - BC1" preset, where you may want all the sound controlled by the BC-1, you might set all the operators' amplitude modulation sensitivities to 3, and the BC range to 99. In something like the E.P-BRS BC (Electric piano-Brass Breath Controlled) voice in the complex & effects group, the piano portion of the voice is not affected by the breath controller because these operators' AM sensitivities are at 0, but the operators in the brass portion of the voice have their AM sensitivities set at 3; the [BREATH CONTROLLER-RANGE] should be 99 for this voice.

With the "Sax - BC1" voice you may want to use the BC-1 for phrasing (EG bias), use after touch for vibrato (Pitch), and use the foot control for overall volume. The Modulation Wheel can be used to apply LFO amplitude modulation.

#### **Pitch modulation with the BC-1**

Turn on the pitch modulation (we assume the range is still set between 50 and 99). You will also need to set the pitch modulation sensitivity within the voice itself to a value of 1 or higher (check this in EDIT mode, and change if necessary). Hold down a key, and blow on the breath controller. You should hear a vibrato effect — the speed has nothing to do with how you blow since it is set by the LFO speed which is programmed into the voice — your breath affects the vibrato depth.

#### **Breath controller techniques**

You can use the breath controller several ways. Take it into your mouth and grip it with your teeth. Touch a key on the keyboard, and begin to blow gently. If the voice is set up for breath controller EG bias, the note will begin to sound, and will become louder the harder you blow. If the voice is set up for pitch modulation, the vibrato will increase as you blow harder. If the voice is set up for amplitude modulation, the tremolo and/or wah-wah will increase as you blow harder.

The EG bias is perhaps the most interesting modulation for the breath controller. When you blow normally, the notes start softly. By tonguing the note (forming the breath with a "T" sound), you can get a harder edge. By finishing the blowing with a "T" sound, you can get the note to end abruptly. Of course, you have to coordinate the blowing with the playing of the notes on the keyboard. Given maximum EG bias modulation and maximum amplitude modulation sensitivity within the voice, there will be no sound when you play a key; the sound will come only when you hold the key and then blow into the BC-1. It may take some practice to achieve the proper coordination.

You can achieve a "growling" effect by humming into the BC-1 while you are blowing. This can create an occasionally useful "gritty" sound for playing saxophone, for instance, or an overdriven lead guitar. You'll want to experiment with combinations of humming, tonguing by means of "T-ing", "D-ing" or "F-ing", and so forth. An "F" or "CH" sound may be better for whistles, while a "too-kah" sound may do the job for a birdsong. The possibilities are particularly exciting when you blend the breath controller effect with the pitch bend wheel or other modulation sources.

#### **Special effects from [DATA ENTRY] while in PLAY mode**

The DX7 [DATA ENTRY] section continues to be

"live" after you exit the FUNCTION mode by pressing one of the [MEMORY SELECT] buttons (internal or cartridge). The [DATA ENTRY] controls only change the last used parameter prior to pressing the [MEMORY SELECT] button. This feature can be useful as an additional live performance control. For example, you might go into the EDIT mode and select [LFO SPEED]. Then go back to the PLAY mode and you can play any voice you like and change its LFO speed by moving the [DATA ENTRY] controls. Similarly, you can go into FUNCTION mode and adjust [MASTER TUNE], then go back into PLAY mode and use [DATA ENTRY] to tune a voice. One application of this characteristic is to achieve simulated "doppler shift" with the train bell or whistle (Doppler effect is the increase in pitch that occurs as two objects move closer together at a rapid rate, and the decrease in pitch as they move apart).

One of the most important parameters to access during performance is the POLY/MONO mode selection. You can exit FUNCTION mode after first pressing [POLY/MONO], and then toggle between these modes while playing various voices.

The ability to change the last selected FUNCTION parameter is particularly useful for changing the portamento characteristics. For example, you can enter FUNCTION mode and adjust the [PORTAMENTO TIME], then play a voice and alter that time as you play.

A very useful "trick" relies upon the difference in portamento that occurs between polyphonic and mono modes. As explained here, you can use [DATA ENTRY] to switch between fingered portamento with a mono keyboard (useful for a Fretless Bass voice), and no portamento with a polyphonic voice (Electric Piano, for example).

1. Wire a standard phone jack so its tip is shorted out to its sleeve (jumper from tip to sleeve). Insert this plug in the Portamento Foot Switch jack on the back of the DX7. It has the same effect as though you plugged in a foot switch but did not step on it.
2. Enter FUNCTION mode, press [POLY/MONO], and set the instrument for MONO operation.
3. Press [PORTAMENTO MODE] and select "FINGERED PORTA". You'll notice that fingered portamento is not sensitive to the portamento foot switch, so it will work even though the shorted jack is present.
4. Press [POLY/MONO] again before leaving FUNCTION mode so that the [DATA ENTRY] slider or

[ON] and [OFF] buttons will toggle the keyboard between polyphonic and mono operation.

5. Press [MEMORY SELECT] (internal or cartridge) to enter the PLAY mode.

When you select a voice like the Fretless Bass, push up [DATA ENTRY] or press [>] to set the DX7 to MONO mode. You can now use fingered portamento (holding one key while pressing and releasing another) to achieve a pitch bending glide to the next note, or play notes sequentially to avoid portamento. If you select another voice, such as Electric Piano, pull down [DATA ENTRY] or press [<] to return to polyphonic operation; since the portamento jack is shorted, there will be no portamento on that voice. If you want, you can use a foot switch in the Portamento jack, in which case the portamento would be active in POLY mode when you step on the pedal.

If you don't want to accidentally have a parameter change whenever you're in PLAY mode, select a non-critical parameter before you exit the FUNCTION mode. From FUNCTION mode, for example, you might press [BATT CHECK] before going into PLAY mode. This will avoid accidental, unexplained changes while you are playing.

## Reference Sources on FM Synthesis

FM digital synthesis, of the type used in the DX synthesizers, was pioneered by Dr. John M. Chowning and his associates at Stanford University in the early 1970's. A number of research papers have been published, and offer the technically-inclined reader ample opportunity to understand the theory and mathematics of FM synthesis.

John M. Chowning, "The Synthesis of Complex Audio Spectra by Means of Frequency Modulation," *Journal of the Audio Engineering Society* Vol. 21, #7 pp 526-534 (Sept. 1973); reprinted in *Computer Music Journal*, Vol. 1, #1, pp 46-54 (April 1977).

John Grey, "An Exploration of Musical Timbre," PhD Dissertation, Dept. of Psychology Stanford University (Feb. 1975); distributed through the Dept. Music, Tech. Rep. Stan-M2.

James A. Moorer, "The Synthesis of Complex Audio Spectra by Means of Discrete Summation Formulas," *Journal of the Audio Engineering Society*, vol. 24, #9, pp 717-727 (Nov. 1976).

James A. Moorer and John Grey, "Lexicon of Analyzed Tones (analysis and plotting programs), Part I: A Violin Tone," *Computer Music Journal* (Box E, Menlo Park, CA 94025), 1(1): 39-45 (1977).

Bill Schottstaedt, "The Simulation of Natural Instrument Tones using Frequency Modulation with a Complex Modulating Wave," *Computer Music Journal*, pp 46-50 (Nov. 1977)

Marc LeBrun, "A Derivation of the Spectrum of FM with a Complex Modulating Wave," *Computer Music Journal*, pp 51-52 (Nov. 1977)

# MIDI: A STANDARD INTERFACE FOR REMOTELY PLAYING AND/OR PROGRAMMING MULTIPLE SYNTHESIZERS

MIDI is an acronym for Musical Instrument Digital Interface, a specification which several manufacturers have already agreed to use for designing equipment which is compatible. MIDI is a non-proprietary "language" which allows different (or identical) synthesizers to "talk" to each other. There are many, many parameters described by MIDI. MIDI-compatible instruments made by any one manufacturer should generally be capable of causing other manufacturers' MIDI compatible instruments to play and to switch from one voice to the next. Computer or sequencer control of multiple synthesizers will be possible using MIDI, and many independent computer software and hardware concerns are working on MIDI related products. Computers will also be able to provide "hard copy" manuscript of an improvisation or composition, and permit video synthesis to be integrated with music synthesis. Almost any computer should be suitable, provided it is fitted with a special hardware interface capable of communicating at 31.25 kilobaud (31,250 bits per second), and programmed to satisfy the MIDI specifications. The standard MIDI interconnect utilizes 5-pin DIN male plugs (Switchcraft 05GM5M or equivalent) on twisted-pair shielded cable (shield to pin 2 of both ends). To avoid data distortion due to cable capacitance, a maximum of 50 feet (15 meters) of interconnect cable may be used.

Some brands of MIDI-compatible instruments may be able to cause other brands to bend pitch, tune the keyboard, and perhaps respond to touch sensitivity, but total compatibility is not necessarily guaranteed by the label "MIDI". In fact, the very methods of sound generation differ between instruments that use MIDI, limiting the remote programming capability. Within a single manufacturer's product line, such as the Yamaha DX series, MIDI can permit extensive programming of one instrument through the controls of another by communicating so-called "system exclusive" information. When dissimilar synthesizers are fed this type of information, they simply ignore it.

Yamaha utilizes extensive system information so, within the DX series, you can perform most functions from a single keyboard. For example, you can program a voice on one DX7 and then transfer that voice to another DX7. You can transfer part of a voice to the other DX7, making it possible to merge parts you like in different voices to create a new voice (this could be done by manually programming each parameter, but MIDI makes it faster and easier). You can transfer all 32 voices from one DX7 to another. You can bend the pitch, tune

the keyboard, or adjust almost any FUNCTION mode parameter remotely and, of course, you can play one instrument from the other's keyboard.

With two or more DX synthesizers connected together, you can use the controls on the Master to control the Slave(s), yet each synthesizer retains its own sensitivity and voice assignments. For example, moving the Master's MODULATION Wheel to full forward deflection might cause a slight bit of LFO pitch modulation on that instrument, while on the Slave there might be a large amount of LFO amplitude modulation with a completely different waveform — it depends on how the two instruments' voices and FUNCTION modes are programmed. Similarly operating the Master's PITCH Wheel would cause a change in each instrument's voice that depends on the individually programmed Range and Step values. This "differential" sensitivity can be helpful as an effect, for example with a steel guitar voice; you can program the same voice into both instruments, then play the Master and use its PITCH Wheel to bend one "string" (one note) on one DX, but not bend the same "string" which MIDI is playing on the other DX. In other cases, you could set the Master to move up in pitch in a continuous slide until, at full PITCH Wheel deflection, the keyboard is up 1/5 octave; at the same time, the Slave could be programmed to move up in pitch by 1/3 step jumps until it reaches a full octave above the starting pitch.

Many of these same things can be done with a DX7 connected to a DX9; the interface automatically compensates for the different algorithms and different numbers of operators. What's more, several synthesizers can be "daisy chained" together for simultaneous playing, and you can switch the voice memories on all of them by pressing a single button. Individual voices on the various MIDI-connected instruments can then be "brought out" or faded by using individual foot controls to adjust the volume.

## MIDI connections

To utilize MIDI, you'll need a suitable cable, available from your Yamaha DX dealer. One instrument will be designated as the Master, and the other instrument(s) as the Slave(s). The Master is the DX which you primarily use to play or program the other DX(s). In the simplest setup, you connect the MIDI OUT jack of the Master to the MIDI IN jack of the Slave.

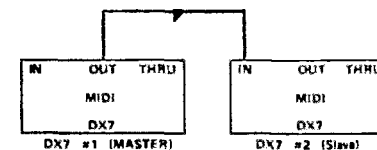

*Standard MIDI setup with two DX7s. You play and/or program voices for both instruments from the Master (which is the one whose MIDI OUT jack is used). You can also play the Slave directly if you wish.*

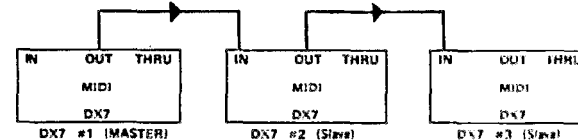

*In this setup, the Master (instrument #1) can be used to play and/or program the first Slave (instrument #2). However, the second Slave, (instrument #3) cannot be remotely controlled by the Master — the first Slave (instrument #2) can control the second Slave (instrument #3). In other words, when MIDI IN/OUT jacks are used to interconnect several instruments, remote playing or programming is possible only from one instrument to the next along the "chain." As always, each instrument can be played or programmed locally.*

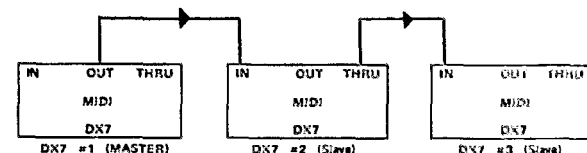

*In this setup, the Master can be used to play or program both Slaves. The difference, compared to the previous setup, is that here the THRU connector of the first Slave (instrument #2) is used to feed IN connector of the second Slave. Additional instruments can also be controlled by the Master by feeding from the THRU connector of one to the IN connector of the next, and so on.*

*NOTE One further MIDI connection diagram is shown at the end of this section of the manual.*

## Transmitting 32 voices from the Master to the Slave

For this discussion, we will assume the simple setup shown with just two DX7 synthesizers. Basically, the same procedure is used when playing more DX7s, or a mixture of other DX synthesizers.

1. Load the 32 voices you wish to transmit into the Master's internal memory
2. Set the Master synthesizer to MIDI channel 1 by pressing [FUNCTION], then press [MIDI] (button 8) until the display shows "FUNCTION CONTROL, MIDI CH= ?", where the question mark may be any number from 1 to 16. If it's at 1, go on to the next step, if not. Use the [-1] DATA ENTRY button to set the instrument so the LCD displays "FUNCTION CONTROL, MIDI CH= 1."
3. Now press [MIDI] once more and the LCD will probably display "FUNCTION CONTROL, SYS INFO UNAVAIL". This means that the synthesizer's MIDI system communication on channel 1 is turned off. Press the [ON] button, and the display will change to "FUNCTION CONTROL, SYS INFO AVAIL". The Master synthesizer is now set to transmit voice data.
4. Now set the Slave to receive on MIDI channel 1 by repeating Steps 2 and 3 above on that instrument.
5. From now on, most changes of the Master's EDIT or FUNCTION mode programming controls will affect the Slave.
6. Press [MIDI] once more on the Master, and its LCD will display "FUNCTION CONTROL, MIDI TRANSMIT?" to which you answer [YES]. In about a second, the 32 voices will be transmitted to the next DX synthesizer (the Slave). When the operation is over, the Slave's LCD will display "FUNCTION CONTROL, MIDI RECEIVED".

*NOTE* If the Slave is a DX9, only the first 20 voices will be transmitted, and they will be truncated to the closest sounding voice that can be achieved with 4 instead of 6 operators. Operators 3, 4, 5 and 6 are transmitted to the DX9, but operators 1 and 2 are not. This will affect some voices more than others. A similar translation will occur when moving voices from DX9 to DX7.

If the Slave did not receive the voices, there are two things to check. First, be sure its memory protection was OFF. Second, be sure both synthesizers were set to MIDI channel 1. (If one is not, you'll have to manually change it from the FUNCTION mode as described

in Step 2.)

## Playing the Slave from the Master

1. Set the Master synthesizer to MIDI channel 1 by pressing [FUNCTION], then press [MIDI] (button 8) until the display shows "FUNCTION CONTROL, MIDI CH= ?", where the question mark may be any number from 1 to 16. If it's at 1, go on to the next step; if not, use the [-1] DATA ENTRY button to set the instrument so the LCD displays "FUNCTION CONTROL, MIDI CH=1."
2. Now set the Slave to communicate on MIDI channel 1 by repeating Step 1 on that instrument. It is not necessary to set "SYS INFO AVAIL" in order to play or select voices via MIDI; the "system information" need be available only when you are transmitting voices or parts thereof from one instrument to the other.
3. Press [MEMORY SELECT-INTERNAL] or [MEMORY SELECT-CARTRIDGE] on the Master, and do the same on the Slave, selecting whichever source of 32 voices you wish to play on the particular instrument. That's it. Now, any time you press a voice selector (buttons 1-32), both instruments will go to that numbered voice memory. Both will play and will respond to modulation controls (if the FUNCTION mode programming is appropriately set in each instrument).

**CAUTION** With or without MIDI, a DX synthesizer's [DATA ENTRY] section continues to be "live" after you exit the EDIT mode or the FUNCTION mode by pressing one of the [MEMORY SELECT] buttons (internal or cartridge). This feature can, in some cases, be useful. However, it can also cause problems when you are using the MIDI system. For example, when you set up the instruments to communicate via MIDI, as they are now, the MIDI channel function may be the last FUNCTION mode operation you perform prior to entering PLAY mode. If you then place the Master synthesizer in EDIT mode to change its voice, the Slave remains in PLAY mode. As soon as you press the [YES] DATA ENTRY button on the Master to change a voice parameter on that instrument, the same [YES] command is sent, via MIDI, to the Slave. On the Slave, however, that command is interpreted to change from MIDI channel 1 to channel 2. The instant this

occurs, there is no more MIDI communication between the two synthesizers, so pressing [NO] on the Master cannot return the Slave to the proper channel. You may not find out about this inadvertent change until you again try to play the two instruments together. The only way to get the Slave back on Channel 1 is to manually press its [NO] button.

*This same effect can cause problems in Master Tune mode, since editing a voice parameter on the Master would throw the Slave out of tune.*

*In order to prevent such Inadvertent channel switching or FUNCTION modification on the Slave, it is a good idea to select an inconsequential FUNCTION mode parameter before entering the PLAY mode - [BATT CHECK] is a good choice. Then the [DATA ENTRY] controls will have no effect so you cannot accidentally switch the Slave(s) to an inoperative channel.*

*NOTE* You can use the "live" [DATA ENTRY] controls to advantage. For example, you might go into the FUNCTION mode and select [PORTAMENTO TIME]. Then go back to the PLAY mode and you can play both instruments and change the time it takes to glide from one note to the next (assuming the portamento effect is in use) through MIDI. This works with multiple DX7s or with a DX7 MIDI connected to a DX9. If you do not want the Slave voice to be modified when you alter the Master voice, select a FUNCTION mode parameter such as [BATT CHECK] prior to selecting PLAY mode on the Slave.

## Transmitting individual voices from the Master to the Slave

You can transmit a voice to the Slave's internal or cartridge memory, provided you first turn OFF the corresponding protection.

1. Make sure that both Synthesizers are set to communicate on MIDI channel 1, as described in Steps 1 to 3 of the "Transmitting 32 voices..." instructions.
2. Turn OFF the memory protection on the Slave by pressing the [MEMORY PROTECT] button corresponding to the memory area you wish to use (INTERNAL or CARTRIDGE), and then pressing the [OFF] button. If you're using a cartridge, be sure to turn OFF its hardware memory protect switch, too.
3. Select the voice on the Master that you want to transmit by pressing [MEMORY SELECT-INTERNAL]

- or [MEMORY SELECT-CARTRIDGE] and then pressing the appropriate VOICE SELECTOR (1-32).
- The voice you just selected on the Master is now located in the edit buffer within the Slave. To save it, press and hold the Slave's [STORE] button, and then press the Slave's voice selector corresponding to the memory number you wish to use (1-32). The voice is now stored in that internal or cartridge memory
  - Turn the memory protection back ON unless you plan to transmit additional voices.

### Using DX7 RAM cartridges to save DX9 voices

MIDI makes it possible to take voices from the DX9, transmit by MIDI to the DX7, and store them on the DX7 RAM cartridge instead of on the DX9 tape. While the RAM storage is more expensive than the tape, the cartridges are sometimes more convenient in live performance situations — or if one's tape recorder fails. This type of alternate storage can be done in the other direction, storing DX7 programmed voices on DX9 cassette. You might wish to do this to save money or if you temporarily run out of cartridge space. It is true that the DX9 tape storage cannot save some of the touch sensitivity parameters, and that the DX7's 6 operators will be truncated to 4, but in some cases the loss of 2 operators will not significantly alter the voice so you may wish to try this technique.

When going from a DX9 to a DX7, the key level scaling will always be set to the exponential curve, with a value corresponding to whatever scaling value had been set the DX9. You may wish to reprogram the voice to have a linear curve after you transmit it to the DX7.

### Programming remotely with MIDI

As already stated, you can remotely control FUNCTION mode parameters by setting both instruments to "MIDI CH 1" and setting them to "SYS INFO AVAIL". You can also remotely control EDIT mode parameters.

- Turn OFF the memory protection on the Slave by pressing the [MEMORY PROTECT] button corresponding to the memory area you wish to use (INTERNAL or CARTRIDGE), and then pressing the [OFF] button. If you're using a RAM cartridge, be sure to turn OFF its hardware memory protect switch, too.
- Select a voice on the Master that you wish to use as a starting point for editing. You can, if you wish, select the same or a different voice on the Slave. If you plan

to create a voice "from scratch" then it doesn't matter what voice is selected on the Slave. However, you can program some parameters on the Master which will then automatically be transmitted to the slave, while other aspects of the Slave's selected voice will remain as they were. In this way, components of two (or more) different voices can be merged.

- Press [EDIT/COMPARE] on the Master.
- You can now transmit an operator's envelope, frequency ratio, or any EDIT mode information from 1 voice on the Master and apply it to another voice on the Slave. As soon as you select or alter any EDIT parameter on the Master, that value change is automatically transmitted to the Edit buffer of the Slave.
- During this process, you can still play the Master keyboard and listen to either the Master or the Slave by selectively adjusting their VOLUME controls (which are not MIDI interconnected) or by using Volume foot controls, or by playing the Slave keyboard to hear just that instrument.
- When you wish to store the voice on the Slave, press its [STORE] button and hold it while pressing the appropriately numbered VOICE SELECTOR (1-32). **MIDI DOES NOT PERMIT YOU TO PRESS THE MASTERS [STORE] BUTTON AND STORE A VOICE ON THE SLAVE. YOU HAVE TO PRESS THE SLAVES [STORE] BUTTON.**
- Turn the memory protection back ON.

### Escaping from MIDI control

You can "turn off" MIDI in any of several ways. The most immediate way is to unplug the cable, although this is not always convenient, and can prematurely wear out the connectors if you do it often. You can also enter the FUNCTION mode on the Master or the Slave and press the [MIDI] button (#8) and either change one instrument to a different channel (press [+1] when the display shows "FUNCTION CONTROL. MIDI CH= 1). If you just want to play remotely but not program remotely set it so that system information is not available (press [NO] when the display shows "FUNCTION CONTROL, SYSTEM INFO AVAILABLE").

### A special setup with two Masters and no Slave

If you are playing on stage and you wish to be able to play two DX synthesizers simultaneously, you could use

the first connection shown, with one Master and one Slave. However, you might wish to stack each DX atop different keyboards, so it might be more convenient to use one DX as the Master for part of your performance, and the other DX as the Master for another part of your performance. This can be done by using a second MIDI cable as shown here. Then, by setting both synthesizers to "MIDI CH=1", you can use either synthesizer as the Master. **DO NOT USE THE THRU** connector in this type of setup unless you also want to control an additional DX from either of the first two.

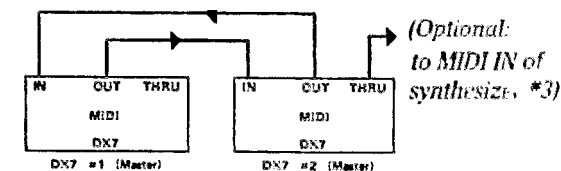

*Special MIDI setup with two DX7s. You play and/or program voices for both instruments from either one. If you use the THRU connector of either synthesizer to feed the MIDI IN connector of a third synthesizer then either of these Masters will control all three instruments.*

### More information on MIDI

MIDI opens up an exciting new world to synthesists. Because MIDI is relatively new, its full potential has yet to be explored. Certainly, the DX7 is capable of more MIDI operations than have been outlined in this text.

In addition, there is already a "MIDI users' group" to share MIDI information. At the time this manual was prepared, information was available from: IMA (International Midi Association), 8426 Vine Valley Drive, Sun Valley, CA 91352, USA. Phone (213) 768-7448.

## MAINTENANCE AND TROUBLESHOOTING

58

### **Cleaning**

The DX7 should be cleaned with a soft, moistened cloth. To remove more stubborn dirt, use a mild detergent solution on the cloth. Do not allow fluid to run into the instrument, and do not use special cleaners since solvents can mar the finish.

### **Internal Memory Battery Backup**

If the internal battery voltage drops below 2.2 volts (see [BATT CHECK] on page 20), the battery should be replaced by an authorized Yamaha DX service center or dealer. Make sure you have saved any internal voices on a RAM cartridge before unplugging the instrument; there is a chance the voices will be lost due to the low voltage (or zero voltage while the battery is being changed). Special lithium batteries are used, and this operation should not be attempted by the owner. The battery life is expected to be from 3 to 5 years.

### **If something goes wrong**

The DX7 circuitry largely consists of a few very special integrated circuits ("chips"). These are generally quite reliable, although malfunctions can occur. If you do not get sound out of the DX7, there is always a chance that the circuitry is malfunctioning. More often, however, the reason can be traced to something less drastic, like a foot controller plugged into the VOLUME jack and set for zero level.

### **IF THERE'S NO SOUND, OR ALMOST NONE**

If you cannot get sound out of the instrument, first recheck all connections to be sure they are made to the proper jacks, including your amplifier and speaker system. Make sure all equipment is turned on, and that the volume controls are set at a reasonable level. Check the DX7 to be sure its foot controller, if plugged into the VOLUME jack, is tilted flat so there is at least some output volume, and, of course, make sure the DX7 front panel VOLUME control is pushed up. If you still hear nothing, unplug the cable from the DX7 output and plug it into another instrument which is known to work, or use a test oscillator, to verify that the cables and the sound system are indeed working. If they are, there are still other reasons why you may not be getting sound from the DX7.

If the DX7 is in EDIT mode, make sure that all the operators are turned ON by selecting a parameter which shows you the algorithm number (such as [EG RATE]) and then look at the six digits in the top row of the LCD

display. They should be "111111" indicating all operators are turned ON. If there are zeros, that may be why you hear nothing. Try pressing the [EDIT/COMPARE] button to get to the "original" voice and see if the sound returns. Another possibility is that the operator output level is turned down. Press [OPERATOR OUTPUT LEVEL] and then press [OPERATOR SELECT] to look at the level of at least the carriers. If the level is below 30, there will be almost no sound; try 99 and see if things improve.

Another possibility is that you have selected a voice which has a lot of amplitude modulation sensitivity programmed into its carriers, and that one of the modulation controls is programmed with a significant amount of amplitude modulation range. Let's say for example, that the voice you are trying to play has its carriers set for an [MOD SENSITIVITY-AMPLITUDE] value of 3 (the maximum), and that the keyboard AFTER TOUCH section has been set, in FUNCTION mode, to a [RANGE] of 99 and that the [AMPLITUDE] is ON. This means that there will be absolutely no sound at all when you play notes unless you begin to press hard on the keys after they "bottom out". You can remedy the situation by several means: turn OFF the AFTER TOUCH amplitude response in the FUNCTION mode or reduce the RANGE for that parameter, select a different voice which does not have as much amplitude modulation sensitivity or reprogram the voice in EDIT mode to have less amplitude modulation sensitivity. The same type of problem can occur if the voice has amplitude modulation sensitivity and the DX7 BREATH CONTROL, FOOT CONTROL or MOD WHEEL sections are programmed (from FUNCTION mode) to have an extreme amount of amplitude modulation range.

### **IF THE KEYBOARD IS MONOPHONIC**

The problem may simply be that the instrument is set to MONO mode. Press [FUNCTION] then press [POLY/MONO] and see if the display shows "MONO MODE" — if it does, use the [DATA ENTRY] controls to change to "POLY MODE."

### **IF THE PITCH WHEEL HAS NO EFFECT OR TOO LITTLE RANGE**

The PITCH Wheel can and must be programmed to be effective. Press [FUNCTION] and then press [PITCH BEND- RANGE] and use [DATA ENTRY] to set the range to whatever maximum you wish. See page 17 for more details.

### **IF THE DISPLAY SHOWS "GARBAGE", LOCKS UP, OR SOME OTHER FUNCTION REFUSES TO OPERATE PROPERLY**

The DX7 is really a very sophisticated computer. Sometimes a random power surge or static spark — even a powerful single cosmic ray believe it or not — can temporarily destroy information in a digital memory. When this occurs, the results are unpredictable. Such malfunctions are known as "soft" errors because they are not caused by actual component failure. Turning the DX7 power switch OFF waiting a half minute, and then turning the power back ON will usually clear this type of "soft" malfunction.

### **IF THE LCD WINDOW REMAINS DARK**

The Liquid Crystal Display (LCD) can be permanently damaged by extreme heat or cold. A symptom is a dark or non-operating display. This problem calls for a replacement display.

### **WHEN ALL ELSE FAILS, READ THE INSTRUCTIONS**

The DX7 is a deceptively simple looking instrument, one which has many functions that are not obvious at first glance. We realize this is a long manual, and there is a strong temptation to skim over portions of it or skip them altogether. If you are having difficulty, we urge you to spend a little time re-reading the appropriate sections of this manual to make sure you understand how the instrument is supposed to work. Then, if things still don't seem right, contact your Yamaha DX dealer for assistance.

## DX SYNTHESIZER GLOSSARY

**ADSR** This is an acronym for "Attack-Decay-Sustain-Release" which, in turn, refers to the four controls provided on a conventional synthesizer's envelope generators. While the DX synthesizers can simulate ADSR-type EGs, the DX EGs are more complex. ADSR EGs have 4 variables, whereas DX EGs have 8 variables.

**After Touch** The DX7 keyboard has pressure transducers beneath the keys that permit the player to alter the sound based on how hard the key is pressed after it "bottoms out." This aspect of touch sensitivity is known as After Touch. It may be used to apply LFO modulation to the pitch or amplitude, or to alter the envelope generator bias, depending on the way the DX7 FUNCTION mode is programmed, and depending on the programmed values within the particular voice.

**Algorithm** An algorithm is an arrangement of operators. It is roughly the equivalent of a "patch" in an older style, modular synthesizer. The DX7 has 32 different algorithms.

**AMD** This is an abbreviation for "Amplitude Modulation Depth." Increasing the AMD value applies more LFO modulation to the operators, which causes their output levels to go up and down according to the set LFO speed and waveform. AMD will have an effect only if the Amplitude Modulation Sensitivity is set higher than 0 for individual operators.

**Amplitude** This refers to the output level of an operator. Amplitude may or may not be related to "volume," depending on whether the operator whose amplitude is being varied is a modulator or a carrier. When the amplitude of a carrier is changed, the "volume" or output level of the synthesizer changes. When the modulator amplitude is varied, the timbre of the voice changes, and, subjectively, the volume may also change (loudness depends on timbre as well as level).

**Attack** This is the beginning of a sound or the initial transient of a musical note. In the DX synthesizer envelopes, L1 generally determines the maximum level of the attack, while R1 determines how rapidly the note reaches L1. R1 can thus be considered the attack rate. In a conventional synthesizer, there is no attack level (L1); it is always at maximum (equal to 99 on the DX), and the attack time is adjustable. The DX envelope's attack time is indirectly set by the attack rate since, if the level is made higher at a given rate, it will take more time to reach that level. If L1 and L2 are zero, however, then R3 and L3 determine the attack time and level, while R2 sets the turn-on delay; R1 should be at 99.

**Break point** In the DX7, the operator output level and the envelope rates may be scaled to increase or decrease as notes are played across the keyboard. With the keyboard level scaling in particular, almost any note may be chosen as the starting point for a boost or cut curve to either side. This starting point is known as the "break point." The break point for keyboard rate scaling is not adjustable, and falls below the lowest note on the keyboard.

**Carrier** When an operator is at the bottom of a stack within an algorithm, where it contributes directly to the output of the synthesizer, it is considered to be a carrier. There is no difference between a carrier and a modulator in that both are operators; their relative arrangement within the algorithm is what differentiates the two.

**Cartridge** In the DX7, there are two types of non-volatile voice storage. One way to store a voice is on the internal memory, which, while it is electronic, is not erased when power is turned off due to an internal battery. The other voice storage medium is the cartridge. There are two types of cartridges, RAM and ROM (see these definitions).

**Cartridge Form** This is an abbreviation for cartridge format. Formatting a RAM cartridge on the DX7 erases all voices and instead sets the 32 memory locations to the "initialized voice" (see INIT). ROM cartridges cannot be formatted.

**CRT** In the DX7, CRT is an abbreviation for "cartridge." (In most other situations, CRT stands for "Cathode Ray Tube.")

**Current operator** In the EDIT mode, this is the operator whose parameters are displayed, and which you can program with the DATA ENTRY controls. Even when several operators are turned ON, you can only adjust or examine one at a time, the "current operator."

**Decay** In a typical musical note, the initial fading of sound after the attack.

**Default** The "default" values for programmed parameters are the values which the synthesizer automatically selects if not otherwise programmed. This primarily applies to the initialized voice or the cartridge format voices.

**Delay** In the DX synthesizers, it is possible to program a voice so that its built-in LFO modulation does not begin as soon as you play a note, but after a certain time. That time span is known as "delay." An envelope

in the DX synthesizers may also be programmed to have delay in that it may not begin sounding the note until some time after the key is depressed (this is a different type of delay than the modulation delay). In a broader sense, delay may describe a signal processing effect which is used to produce echo (i.e., analog delay or digital delay units).

**EDIT mode** This mode permits you to program individual parameters of a voice (such as the envelope, operator frequency, keyboard scaling, and so forth). EDIT mode may be entered by pressing [EDIT/COMPARE].

**EEPROM** This is an acronym for "Electrically Erasable, Programmable, Read Only Memory" The RAM cartridges contain EEPROMs which store the voice data. There are no moving parts nor any batteries in an EEPROM; the data is stored by means of an electric current that "burns a pattern" in the memory, and erased by a different electric current, both of which are supplied by the DX7.

**EG** This is an abbreviation for "Envelope Generator" An envelope generator is the circuit which creates the "shape" of a note — the rates at which it turns on and dies away and the intermediate levels. The DX7 has 6 primary EGs, one to shape the output level of each operator, plus another EG which changes the pitch of all 6 operators.

**Envelope** This is the overall "shape" of a note in terms of its output level. When you play a note, typically the sound rises to some level, then falls to another level, and, when you release the key, falls to zero level — although there are many exceptions. The specific rates at which the levels change, and the intermediate and final levels, together define the envelope. In the DX7, envelopes may apply to carriers (which change the volume of the sound), to modulators (which change the timbre) or to the pitch (which changes the frequency of the note). Envelopes are programmed with the EG (envelope generator).

**Feedback** In general, feedback is the return of the output from a circuit to the circuit's input. The DX7 allows for feedback from the output of an operator back to its input, or to the input of an operator higher up in the same "stack" of the algorithm. All 32 algorithms have feedback paths, but there is feedback only if the voice is so programmed. Feedback may be set to any of 8 levels from 0 (no feedback) to 7 (maximum). The effect of feedback is similar to the use of an additional modulator, though not precisely the same.



**Fingered Porta** This is an abbreviation for "fingered portamento." This is a functional mode of the DX7 which is available only when the keyboard is set to MONO operation. Provided the unit is set to fingered portamento, and the portamento time is greater than 0 (actually greater than 30 for any significant effect), you will hear portamento only when you continue holding down one key and then press and release another key. Pressing one key at a time will produce no portamento.

**FM** An abbreviation; see "Frequency Modulation."

**Frequency Modulation** When the output level of one waveform is made to vary in frequency by a circuit which combines it with a second waveform, the resulting complex waveform is said to be the result of frequency modulation. This is not the simple mixing of two frequencies, but rather it is a process which results in the creation of sum and difference frequencies (the fundamental plus the modulating frequency, the fundamental plus twice the modulation frequency and so forth, and the fundamental minus the modulating frequency and so forth). Some of these "sidebands" theoretically extend below 0 Hz, which is actually impossible in an analog synthesizer. However, the FM digital synthesizer correctly follows the equation for FM by "reflecting" the negative frequency components back into the positive frequency domain, but with their phase shifted 180 degrees. In some cases, these "reflected" components will subtract from the level of the fundamental or certain harmonics. Therefore, frequency modulation not only creates side frequencies, it also changes the balance between the fundamental, harmonics and subharmonics. This is one reason why FM synthesis can create such interesting harmonic structures.

In the DX7, all the various, complex waveforms are created by means of frequency modulation with sine waves.

**FUNCTION mode** This is a mode of operation wherein the overall performance parameters of the instrument are programmed, such as polyphonic or monophonic operation, or modulation from the modulation wheel, after touch, breath controller and foot controller. FUNCTION mode is also used to tune the keyboard, to check the backup battery condition, to save or load voices from a RAM cartridge, and so forth.

**Fundamental** This is the basic pitch of a musical note. A note consisting only of the fundamental is a "pure" tone, a sine wave. Most instruments play notes that also

contain varying amounts of overtones (harmonics) in addition to the fundamental; the overtones create the unique timbre of a given instrument. In the DX synthesizers, the carrier often defines the fundamental pitch of a voice, but not always; sometimes, due to the effects of the modulators, the frequency of the fundamental may be higher or lower than the set frequency of the carrier.

**Harmonics** These are integer multiples of a fundamental frequency. The "first harmonic" is the fundamental. The second harmonic is twice the fundamental, and so forth. Harmonics are similar to overtones, except the first overtone is the second harmonic. In the DX synthesizers, harmonics are generally created by the interaction of the modulator(s) with the carrier(s), although parallel carriers set at integer multiples can also produce harmonics.

**Hz** This is an abbreviation for "Hertz," the unit of measurement for frequency. 1 Hz is equal to one cycle per second (1 cps).

**INIT** This is an abbreviation for "initialize." In the DX synthesizers, there is no such thing as erasing a voice memory. The memory including the editing buffer, will always contain some data... some numbers that describe a voice. If all data were set to zero, you would hear nothing, and it would take a lot of programming to get any sound at all. Therefore, when you INITIALize the buffer memory or the entire RAM cartridge (which you can do with the [CART FORM] button in FUNCTION mode), the DX7 stores a very simple, basic voice in the memory. This voice has all "square" envelopes (all rates and levels at 99 except level 4, which is 0 — operator 1 output level at 99 and all others at 0 — all frequency ratios at 1.00 — all modulation and other parameters set to 0 or minimum value).

**INT** This is an abbreviation for "internal," as in "internal voice". The DX7 has two primary places to store voices, in the cartridges or in its internal memory. The LCD display often abbreviates the source of an internal voice as "INT."

**Key Pitch Follow** This is one of the two ways the portamento or glissando effect can be set when the synthesizer is in the POLY (polyphonic) mode. If you play a note or chord and hold down the sustain pedal, then release that note or chord and play any other note or chord, the sustaining pitch(es) from the first note/chord will slide up or down to the most recently played note/chord.

**Key Pitch Retain** This is one of the two ways the portamento or glissando effect can be set when the synthesizer is in the POLY (polyphonic) mode. If you play a note or chord and hold down the sustain pedal, then release that note or chord and play any other note or chord, the sustaining pitch(es) from the first note/chord will continue to sustain at their original pitches. At the same time, the most recently played note or chord will begin at the pitch of the sustaining note/chord, and will then slide up or down to the proper pitch(es).

**kHz** An abbreviation for "kiloHertz," or 1,000 Hz.

**LCD** This is an abbreviation for "liquid crystal display." This is the type of display technology used to indicate the name of selected edit parameters, functions and voices on the DX7. Liquid crystal displays operate by means of special chemicals which change their light polarization characteristics when voltage is applied to them. In combination with a constant polarized layer, the voltage-altered crystal cancels out the light completely forming the black dots which create the alphabetical and numerical symbols in the display. You can test this effect by looking at the LCD with polaroid sunglasses — at a certain angle, the display will be completely black. LCD displays do have a limited viewing angle due to the effect of light polarization, and at very high or very low temperatures they may not function correctly. However, they are reliable, quite visible in bright light, and they use very little power (making them popular for wrist-watches and calculators).

**LED** This is an abbreviation for "light emitting diode." This is the type of display technology used to indicate the number of the selected internal or cartridge voice on the DX7. Numerical light emitting diode displays actually consist of 7 segments for each number. Voltage applied to the diodes is converted to light, red light in this case. The DX7 LEDs are very visible in low light levels and can be viewed over a wide angle.

**LFO** This is an abbreviation for "low frequency oscillator." Like the sine wave "oscillators" in the operators, the LFO in the DX7 is actually a digital oscillator. However, it can be set to create a square wave, a triangle wave, an upward moving sawtooth, a downward moving sawtooth, or a sample-and-hold wave (random output) as well as a sine wave. The LFO output can be varied in "speed" over a range from under 1 Hz to about 50 Hz. The LFO can be assigned to vary the amplitude of individual operators, or the pitch of the entire voice.

**Load** In the DX7, "Load" describes the process of transferring the 32 voices from one bank of a ROM cartridge, or from a RAM cartridge, into the 32 internal memories.

**MIDI** This is an acronym for Musical Instrument Digital Interface, a specification which several manufacturers have already agreed to use for designing equipment which is compatible. MIDI is a non-proprietary "language" which allows different (or identical) synthesizers to "talk" to each other. MIDI-compatible instruments made by any one manufacturer should generally be capable of causing other manufacturers' MIDI-compatible instruments to play, and to switch from one voice to the next. Computer or sequencer control of multiple synthesizers will be possible using MIDI. Within a single manufacturer's product line, such as the Yamaha DX series, MIDI can permit extensive programming of one instrument through the controls of another by communicating so-called "system exclusive" information; when dissimilar synthesizers are fed this type of information, they simply ignore it.

**Modulation** This is the process of varying one signal with another. See "Frequency Modulation."

**Modulation Index** This refers to the ratio between the output level of a modulator and the level of the carrier which it is modulating. The greater the modulation index, the more harmonics are produced (the wider the bandwidth of the FM-generated complex tone). When you turn up the level of a modulator, you increase the modulation index.

**Modulator** In general terms, this is the circuit which allows one signal to modulate another. In the DX synthesizers, a modulator is an operator which sends its signal to another operator (either another modulator or a carrier) rather than directly to the output. The only thing that differentiates a modulator from a carrier is its position within the algorithm; carriers are on the bottom row of the stack(s) and modulators are above them.

**OP** This is an abbreviation; see "operator."

**Operator** This is a functional block within the circuitry of the DX synthesizer. An operator can be thought of as an oscillator, but it is somewhat more complex. It is actually a digital sine wave oscillator which includes a digital envelope generator. The frequency and output level of an operator are adjustable. Operators actually have multiple inputs so that they can be fed signals from more than one source (i.e., an operator serving as a carrier may accept signals from two or three modulators). The DX7 has 6 operators, all identical.

**Parameter** In general terms, a parameter is any definable characteristic of a device or system. In the DX synthesizers, "performance parameters" refer to those characteristics of the instrument that, when adjusted from the FUNCTION mode, affect the overall keyboard — or at least affect more than a single voice. For example, adjusting the keyboard's pressure sensitivity (After Touch) is considered to be a "performance parameter" because it affects any voice which is programmed to be modulation sensitive. "Editing parameters" refer to those characteristics that can be programmed for an individual voice when the instrument is in the EDIT mode (such as the choice of an algorithm).

**PLAY mode** In the DX7, this is the operating mode from which you can select and play voices stored in a cartridge or an internal memory. You select PLAY mode by pressing either [MEMORY SELECT-INTERNAL] OR [MEMORY SELECT-CARTRIDGE].

**PMD** This is an abbreviation for "Pitch Modulation Depth." Higher PMD values apply more LFO modulation toward changing the pitch of a voice when you play a note, provided the [MODULATION SENSITIVITY-PITCH] setting is greater than zero.

**Preset** A preset is a voice which can be played without having to be programmed. Some synthesizers force the player to program any voice which is to be played. Other instruments have only factory presets — basically fixed, unalterable voices. Still other synthesizers offer a combination of programmable and preset voices. The DX synthesizers go a step further. They offer complete programmability plus presets (in the form of internal and cartridge memories on the DX7), but the presets are, themselves, completely programmable. Because the DX preset voices can be edited, a better term might be "primary voices." Yamaha uses the term "preset" only because it is familiar to synthesists, and the DX series require enough new terminology without coining another new term.

**RAM** This is an acronym for "Random Access Memory." In computers, RAM is the "main memory" the solid state area where programs are stored while they are active, and where data is temporarily stored until it is transferred to secondary storage such as a floppy disk, hard disk, magnetic bubble memory or magnetic tape. Such computer RAM memories are usually categorized in terms of how many bytes of 8 bits each they can store; a 1K RAM holds about 1,000 bytes (actually 1K is 1,024 bytes). In the DX synthesizers, RAM does not refer to the

internal memory (although that is, in fact, a RAM memory). Instead, the term refers to an electronic secondary memory — the EEPROM cartridge — and its size is defined not in bytes, but in voices. The RAM cartridges each hold 32 voices. The RAM cartridges are truly random access memories since each voice can be written to or read from the cartridge independently of the others, or all 32 voices may be moved at once. However, the DX7 RAM cartridges differ from conventional RAM in that the cartridges retain their memory after power is turned off, without the use of backup batteries.

**Release** In a synthesizer, this is the time it takes for the note to die away after you let go of the key. In the DX7, rate 4 of the envelope is equivalent to the release rate; the release time will depend on the level at the moment the key is released, since, for a given rate, the time is greater if the level is greater.

**ROM** This is an acronym for "Read Only Memory." In computers, ROM is generally provided for storage of small to medium sized, often-used programs such as self-test routines, BASIC language, input/output drivers, and so forth. ROM is generally provided on IC chips that cannot be altered. In the DX7, the factory "preset" voices are stored in ROM chips inside the ROM cartridges. Each of these cartridges holds 64 voices. Simple ROM chips can only be programmed at the time of manufacture, like those in the DX7 voice ROM cartridges. Semi-ROM chips can be programmed after their manufacture by using special equipment; these are known as PROMS (Programmable Read Only Memories). Some PROMs can also be erased (usually by exposure to ultra-violet light) and can then be reprogrammed; these are known as EPROMs (Erasable Programmable Read Only Memories). Finally, some EPROMs are electrically erasable so that they can be reprogrammed easily without special equipment; these are called EEPROMs (Electrically Erasable Programmable Read Only Memory) — and Yamaha calls them RAM in the DX7, although they differ from conventional RAM (see RAM definition). EEPROMs may also be called EAROMs (Electrically Alterable Read Only Memories).

**Sample and hold** This is a random "waveform." It jumps from one level to another in a non-periodic fashion, unlike the regular, uniform changes in level associated with sine, sawtooth, square or triangle waves. In the DX synthesizers, a sample and hold signal may be selected for use in the LFO section.

**Save** In the DX7, "Save" describes the process of simultaneously placing all 32 internal memory voices into the correspondingly numbered RAM cartridge memories.

**Sawtooth wave** A waveform that contains the fundamental and both odd and even harmonics. In conventional synthesizers, a sawtooth wave may be used to create rich, "brassy" sounds. In the DX synthesizers, such sounds are created by the frequency modulation of sine waves. However, two sawtooth waves (saw up and saw down) may be selected at sub-audible frequencies for use in the LFO section.

**Sine wave** A pure waveform that contains only the fundamental and no harmonics. The operators in the DX synthesizers produce only sine waves. A sine wave also may be selected at sub-audible frequencies for use in the LFO section.

**Square wave** A waveform consisting of the fundamental plus its odd-order harmonics. In conventional synthesizers, square waves may be used to create hollow, reedy sounds. In the DX synthesizers, such sounds are created by the frequency modulation of sine waves. However, a square wave may be selected at sub-audible frequencies for use in the LFO section.

**Stack** In the DX synthesizers, the term refers to a vertically related column of operators. The operator at the bottom is always a carrier, and those above it in the stack are modulators. Some algorithms have no stacks because all the operators are on the bottom row (DX7 algorithm #32, for example), whereas others have two or three stacks (DX7 algorithms #1 and #5, for example).

**Store** In the DX7, "Store" describes one of two processes. In the edit mode, the [STORE] button is used to copy an envelope from one operator to the next. In the play mode, the same [STORE] button is used to place the currently selected voice (the one which is being played or edited) into any location (1-32) in the internal or RAM cartridge memories.

**Sus-Key Pitch Follow** This is an abbreviation for "Sustain-Key Pitch Follow." See "Key Pitch Follow."

**Sus-Key Pitch Retain** This is an abbreviation for "Sustain-Key Pitch Retain." See "Key Pitch Retain."

**Sustain** In a synthesizer, the sustain describes the level which a note "settles into" while a key is held down, or while the sustain foot pedal is pressed down. Some voices have no sustain (no sustain level) in that they continue to fade out after the initial sound even when

the key is held down. In the DX synthesizers, L3 in the envelope determines the sustain level.

**Sync** This is an abbreviation for "synchronize" or "synchronization." In the DX7 there are two types of sync that may be programmed. One is the LFO KEY SYNC; when it is ON, the LFO waveform re-starts at the same point each time you play a note; when it's OFF the LFO wave continues with each note. The second type of sync in the DX7 is OSCILLATOR KEY SYNC. When KEY SYNC is ON, the phase of each note begins at zero, whereas when the sync is OFF; a smoother transition occurs to the next note played because the oscillator does not re-start at zero phase. (We use the term "oscillator" loosely here; the DX actually has digital circuits which simulate oscillators.) Sometimes a voice will sound more natural with sync OFF because, when you play a note successive times, it may sound slightly different — just like an acoustic instrument.

**Transient** An abrupt increase in signal level. In music, transients are produced by percussive or plucked instruments, such as a drum head being struck or a guitar string being plucked. A transient may also be an undesirable signal, such as a "click" or "thud" caused by an amplifier being switched on or off. In synthesis, the transient of a note often refers to its initial attack, as created by the envelope generator.

**Triangle wave** This is similar to a sine wave, but with some harmonic content. A triangle wave at a sub-audible frequency may be selected in the DX7 LFO section.

**Voice** This is a programmed sound for a synthesizer. Another term might be "instrument." Some polyphonic keyboards use the term "voice" to describe the number of keys that may be played simultaneously but DX synthesizers use the word "note" to express this concept. Thus, the DX7 is a 16-note polyphonic synthesizer that can store 32 voices in its internal memory.

# DX7 SPECIFICATIONS

## Keyboard

61 keys, C1 to C6: velocity and pressure sensitive (Initial & After touch): 16 note polyphonic, and may be set to monophonic

## Sound Source

FM digital tone generators: 6 operators and 32 algorithms

## Internal Memory

RAM memory with 32-voice capacity; battery back-up prevents loss when AC power is turned OFF  
Lithium battery has 3 to 5 year service life.

## External Memory

RAM cartridge with 32-voice capacity; non-volatile EEPROM does not require battery. These cartridges are used to save user-programmed voices or edited presets.

ROM cartridge with 64-voice capacity (2 banks of 32 voices, with switch): these cartridges hold the preset voices,

## Mode Selectors

STORE, MEMORY PROTECT-INTERNAL, MEMORY PROTECT-CARTRIDGE, OPERATOR SELECT, EDIT/COMPARE, MEMORY SELECT-INTERNAL, MEMORY SELECT-CARTRIDGE, FUNCTION

## Controls

VOLUME, DATA ENTRY (slider plus pair of adjacent buttons for Yes/No, On/Off, >/<, or +1/-1), PITCH WHEEL, MODULATION WHEEL, OPERATOR ON-OFF; EG COPY (For other controls, see "Voice Parameters" and "Function Parameters" in these specifications)

## Voice Parameters

### (EDIT MODE)

ALGORITHM ..... 1-32  
 FEEDBACK ..... 0-7  
 LFO:  
 WAVE triangle, saw down, saw up, square, sine,  
 S & H  
 SPEED ..... 0-99  
 DELAY ..... 0-99  
 PITCH MODULATION DEPTH ..... 0-99  
 AMPLITUDE MODULATION DEPTH ..... 0-99  
 SYNC ..... ON/OFF  
 PITCH MODULATION  
 SENSITIVITY ..... 0-7  
 AMPLITUDE MODULATION  
 SENSITIVITY\* ..... 0-3

## OSCILLATOR:

MODE\* ..... RATIO/ FIXED (Hz)  
 SYNC ..... ON/OFF\*  
 FREQUENCY COARSE\* 0.5-31 (1 Hz -10 kHz)  
 FREQUENCY FINE\* ..... FREQ.COARSE  
 times 1.00 -1.99\*  
 DETUNE\* ..... -7-+7  
 EG:  
 RATE (1-4)\* ..... 0-99  
 LEVEL (1-4)\* ..... 0-99  
 KEYBOARD LEVEL SCALING:  
 BREAK POINT\* ..... A-1 to C8  
 CURVE (L, R)\* ..... ± LINEAR, ± EXP  
 DEPTH (L, R)\* ..... 0-99  
 KEYBOARD RATE SCALING\* ..... 0-7  
 OPERATOR OUTPUT LEVEL\* ..... 0-99  
 KEY VELOCITY SENSITIVITY\* ..... 0-7  
 PITCH EG:  
 RATE (1-4) ..... 0-99  
 LEVEL (1-4) ..... 0-99 (± 4 octaves)  
 KEY TRANSPOSE ..... ± 2 octaves  
 VOICENAME ..... Up to 10 characters

## Function Parameters

### (FUNCTION mode)

MASTER TUNE ..... ± 75 cents  
 POLY/MONO .. 16 note polyphonic/1 note mono  
 PITCH BEND:  
 RANGE ..... 0-12 (1 octave)  
 STEP ..... 0-12  
 PORTAMENTO MODE:  
 POLY ..... RETAIN/ FOLLOW  
 MONO ..... FULL TIME/FINGERED  
 GLISSANDO ..... ON/OFF  
 TIME ..... 0-99  
 MODULATION WHEEL:  
 RANGE ..... 0-99  
 PITCH ..... ON/OFF  
 AMPLITUDE ..... ON/OFF  
 EG BIAS ..... ON/OFF  
 FOOT CONTROL:  
 RANGE ..... 0-99  
 PITCH ..... ON/OFF  
 AMPLITUDE ..... ON/OFF  
 EG BIAS ..... ON/OFF  
 BREATH CONTROL:  
 RANGE ..... 0-99  
 PITCH ..... ON/OFF  
 AMPLITUDE ..... ON/OFF  
 EG BIAS ..... ON/OFF

## AFTER TOUCH:

RANGE ..... 0-99  
 PITCH ..... ON/OFF  
 AMPLITUDE ..... ON/OFF  
 EG BIAS ..... ON/OFF

## Signal Connections

OUTPUT (T.S. PHONE JACK) -10 dBm, 600 ohm unbalanced  
 HEADPHONES (T.S. PHONE JACK) 8 - 150 ohm mono or stereo phones

## Control Connections

FOOT SWITCH (2 T.S. phone jacks):  
 SUSTAIN ..... ON/OFF  
 PORTAMENTO ..... ON/OFF  
 FOOT CONTROL (2 T.S. phone jacks):  
 VOLUME ..... 0 - maximum  
 MODULATION .. 0 - Max MOD WHEEL RANGE  
 MIDI  
 (5-pin DIN type female jacks) ..... IN,OUT,THRU

## Other Features

LCD DISPLAY ..... 16 char. x 2 lines  
 LED DISPLAY ..... 2 numbers w/decimal  
 CARTRIDGE INTERFACE .. For DX RAM or ROM only

## Dimensions/Weight

WIDTH ..... 40" (101.2 cm)  
 HEIGHT ..... 4" (10.2 cm)  
 DEPTH ..... 13" (32.9cm)  
 WEIGHT ..... 31.2 lbs (14.2 kg)

## Temperature Range

32°F (0°C) to 104°F (40°C)

## Accessories\*\*

2 ROM cartridges, RAM cartridge, music stand.  
 FC-3A foot controller (for VOLUME or MODULATION), FC-4 or FC-5 foot switch (for PORTAMENTO or SUSTAIN), BC-1 breath controller.

\*Those voice parameters marked with an asterisk may be programmed individually for each of the 6 operators; other voice parameters apply to the voice as a whole.

\*\*Certain accessories are standard, and others are optional, depending upon the part of the world where the instrument is sold. Check with your dealer.

Specifications are subject to change without notice or obligation.

# INDEX

64

**AC power** C\*,12-14,20,27,58,59,61,63  
**after touch** C,4,10,16,21,23,42,44,52,58,59,61,63  
**algorithm** 6,9,24-26,28,33,34,38,39,44,46,47,52,55,59,62,63  
**AMD (amplitude modulation depth)** 6,40-43,51,59,63  
**amplitude modulation** 4,6,7,10,11,22,23,40,43,53,58,59,63  
**audio output** 4,12-14,23,63  
**battery (batt check)** C,4,5,10,16,20,54,56,58-61,63 BC-1 (see "breath controller")  
**bias** (see "E.G. Bias")  
**break point** 39,40,45,51,59,63  
**breath controller** 4,6,10,11,12,16,21,23,42,43,53,63  
**buffer** 10,27,28,32,46,57,60  
**carrier** 6-8,10,23-29,32,33,35-38,40,42,43,45,52,53,58-62  
**cartridge** C,3-6,9,10,14-16,20,22,27,28,38,46,47,49,50,54,56,57,59-63  
**cartridge form(at)** 9,20,59  
**character** 5,6,8,45,46,63  
**compare** (see "edit/compare")  
**connections** C,4,10,12,13,20,55-58,63  
**data entry** C,3,4,6,8-10,15-22,28-35,37-47,53,54,56,58,59,63  
**display** C,3,5,6,9,10,12,14,20,21,28-30,32,33,37,38,40,47,49  
**edit/compare** 4,5,8,47,48,57-59  
**edit mode** 3-9,11,15,20,26-28,33,38,46-18,51,53,54,56-59,61-63  
**edit recall** 9,16,20,38,46,63  
**EEPROM** C, 59,61,63  
**EG** C,3,4,6,7,21,26,28-32,37,38,44,51,58,59,63  
**EG bias** 10,11,21-23,53,63  
**EG copy** 4,6,37,44,63  
**envelope** 3,5-9,23,24,26-30,37-39,44,51-53,57,59-63  
**feedback** 6,25,28,39,51,52,59,63  
**fingered porta(mento)** 9,19,54,60,63  
**FORM** (see "cartridge format")  
**FM** C,23,24,38,52,54,60,61,63  
**frequency** 4,6-9,11-13,25,27,31-33,35-38,40,42-45,48,52,57,59-63  
**frequency modulation** 25,33,35,38,51,52,54,60-63  
**full time porta(mento)** 9,19,20,63  
**function mode/parameter** 3,4-11,15-17,20-23,32,33,37,38,46,49,51,53-61,63  
**glissando** 4,9,17-20,60,63  
**harmonic** 7,32,34-36,43-45,51-53,60-62  
**headphones** C,11,12,14,63  
**INIT** (see "voice Initialize")  
**Initial touch** C,11,63  
**INT** 14,60

**Internal memory** C,4-6,9,10,14,15,20,22,38,46,47,49,50,54,56-63  
**Key Pitch Follow** 9,18,19,60,62,63  
**Key Pitch Retain** 9,18,19,60,62,63  
**key transpose** (see "transpose")  
**keyboard level scaling** 4,7,38-40,43-45,51,57,59,63  
**keyboard ratescaling** 8,38,39,46,51,59,63  
**key sync** (see "sync")  
**LCD** C,3,5,6,14-16,18,21,22,47,49,56,58,60,63  
**LFO (includes LFO: AMD, delay, modulation, PMD, speed, sync, wave)** 6,7,10,11,21,22,40-43,51-56,59-63  
**load** C,4,6,9,10,14-16,49,56,60,61  
**memory** C,4-6,9,10,14,15,22,32,38,46,47,49,50,54,56-63  
**MIDI** 4,12,20,55-57,63  
**modulation** (see "LFO" and "frequency modulation")  
**modulation foot control** C,4,6,10,12,15,21,23,53,60,63  
**modulation sensitivity** 6,7,10,11,21,22,40-43,51,53,58,59,61,63  
**modulation wheel** C,4,6,10,11,15,21,22,43,53,55,60,63  
**modulator** 6,8,10,35-40,43,45,47,52,53,59,60,61  
**music rack** 12  
**operator** 3-8,10,11,20,22,31,33-35,37-40,42-45,47,48,51-53,55-63  
**operator output level** 7,10,33-36,39,40,44,45,51-53,48,49,63  
**oscillator** C,6,7,31,40,58,60-63  
**output** 3,4,16,12-14,21,51,58,59,61,63  
**pitch** 6-8,10,11,16,18,19,21-23,31-33,39,40,42,43,45,47,51-55,59-61,63  
**pitch (bend) wheel** 8,9,11,17,53,55,58,63  
**pitch EG** C,8,52,59,63  
**play mode** 3-6,10,14,15,53,54,56,61,63  
**PMD (pitch modulation depth)** 6,40-43,51,61  
**poly (polyphonic)** C,9,11,14,16-20,54,58,60,62,63  
**portamento** C,4,9,12,15,17-20,54,60,63  
**preset** C,4,5,8,9,14,27,38,40,46-48,51-53,61,63  
**pressure sensitivity** 4,11,15,44,53  
**program/programming** C,4-11,15-17,20-23,31-34,37,38-45,47.  
**RAM** 0,4,5,9,10,20,27,38,46,47,49,50,58-63  
**range** 8-11,17,20-23,40,51,53,55,58,63  
**reference** C,3-5,55,57  
**ROM** C,5,9,10,14,15,47,49,51,59,61-63  
**Save** C,5,6,10,27,46,47,49,57,58,60,62,63  
**split keyboard** 7,39,40,44,45  
**stack** 24,25,28,35,39,43,45,47,52,57,59,61,62  
**step** 4,5,7,9,11,17,19,20,55,63  
**Store** C,5,6,8,10,14,27,34,37,44,46,47,49,50,52,53,57,59-63

**Sus-Key Pitch Follow** (see "key pitch follow")  
**Sus-Key Pitch Retain** (see "key pitch retain")  
**sync** 6,7,31,42,43,62,63  
**transpose** 8,11,16,63  
**velocity sensitivity** 8,11,16,45,47,51,63  
**voice initialization** C,4,9,16,20,27-29,32,33,37,38,47,49,51,59,60  
**voice name** 4,6,8,45,47,49,54,63  
**voice ROM** (see "ROM")  
**volume** C,4,7,8,10,12-14,22,26,29-32,40,43,44,51,53,57-59,63  
**volume foot control** C,4,12,55,57,58,63

\*"C" designates the front cover, which includes the "Precautions" and "Introduction" sections.



DX7 OM

5/20/99 19E0112



DX7 OM



**YAMAHA**

international Corp., Box 6600, Buena Park, Calif. 90622



Yamaha Corporation of America  
6600 Orangethorpe Avenue, P.O. Box 6600  
Buena Park, CA 90622-6600



Recycled



Recycled



DX7 OM