

FOR INSTANT SOUNDS TURN TO PAGE 42.



# Odyssey Owner's Manual



# Introduction

Welcome to the ARP Odyssey, the ultimate musical trip. The ARP Odyssey brings polyphonic electronic music to the performing artist—rock, pop, soul, jazz, or avant-garde. It includes such state-of-the-art firsts as phase-locked oscillators, digital ring modulator, sample & hold circuits, and most of the functions of a complete studio synthesizer.

With its ease of operation and high reliability, your ARP Odyssey can produce an enormous variety of sounds in live performance. Everything from thunder and lightning to gong, fuzz guitar, and feedback distortion is at your fingertips with the Odyssey's slider controls and patch switches. The Odyssey's foot pedal and foot switch add to your expressive control. Its two-voice, 37-note keyboard has a nine-octave range. The Odyssey is compatible, and can be interfaced with all other ARP synthesizers. And, of course, the famous ARP filters and oscillators give you drift-free accuracy for professional-quality recordings.



# Odyssey Owner's Manual



THE ARP ODYSSEY

# Contents

Getting Started . . . . .	4	Experiment 4. The VCF . . . . .	22
External Amplifier and Speaker . . . . .	5	Controllers. . . . .	28
What Kind of Amp Works Best. . . . .	5	Keyboard and Pedals . . . . .	29
Let's Begin. . . . .	6	ADSR and AR Envelope Generator. . . . .	30
How your Odyssey Works . . . . .	7	Sample and Hold. . . . .	33
Sound Sources . . . . .	10	Low Frequency Oscillators . . . . .	36
Experiment 1. Listening to Waveforms . . . . .	11	Pitch Bend Control . . . . .	36
Experiment 2. Pulse Width Modulation . . . . .	14	External Audio Input. . . . .	37
Experiment 3. Phase Synchronization . . . . .	15	Interface Jacks . . . . .	37
Experiment 4. Noise . . . . .	7	Panel Control Description Chart. . . . .	39, 40
Experiment 5. Frequency Modulation . . . . .	7	Hints on Using Your Odyssey . . . . .	41
Modifiers. . . . .	19	Instant Odyssey . . . . .	42
Experiment 1. Ring Modulation . . . . .	20	Patches . . . . .	43-54
Experiment 2. The VCA . . . . .	21	Specifications . . . . .	55, 56
Experiment 3. The High-Pass Filter. . . . .	22	Give Your Odyssey a Little Brother . . . . .	Back Cover

Copyright 1976 by ARP Instruments, Inc.  
320 Needham Street  
Newton, Massachusetts 02164

Second Edition  
First Printing . . . March, 1976

# Getting Started

The Odyssey belongs to the class of Variable synthesizers. A variable synthesizer, as opposed to a Preset synthesizer, allows you to shape every aspect of a sound, from the attack and decay to the harmonic structure. Your Odyssey is equipped with controls that will let you precisely shape each and every parameter of the sound you are creating.

Synthesizers create sounds electronically in much the same fashion that any natural sound is created acoustically. There are definite elements of sound which, when put together in different combinations, will precisely reproduce anything from a clarinet to a jackhammer. The Odyssey is a musical instrument comprised of a number of different electronic circuits; each one is designed to control an element of sound.

This manual is an operational guide for the Odyssey, but it should also give you a working knowledge of electronic music functions.

## Checklist:

- Fill out your warranty card and send it in.
- Save the carton (It can be used to protect your Odyssey until you get a carrying case).
- Place the Odyssey on a suitable playing surface (Don't worry about ventilation; it won't get hot).

## EXTERNAL AMPLIFIER AND SPEAKER

The Odyssey, like all electronic musical instruments, is designed to be connected to an amplifier and loudspeaker system. This external equipment (amplifier and loudspeaker) may be a guitar amplifier, P.A. system, an electronic organ, recording console, or even a high fidelity or stereo system. Two outputs are provided on the rear panel of the synthesizer—a phono jack labeled “Low” and a smaller phono jack labeled “High.” Use the outputs in the following manner:

- If you are planning to plug your synthesizer into a guitar amplifier, use the synthesizer’s “Low” output. A standard guitar cord can be used for this connection.
- If you’re using the synthesizer with an organ or a hi-fi amplifier, use the output marked “High.” An input jack is already available on most organ models. In the event your organ is lacking this input, it will only take a serviceman a few moments to install one. Ask him to wire the jacks so the volume of the synthesizer can be controlled by the expression pedal of the organ.

## WHAT KIND OF AMP WORKS BEST?

The whole idea of a synthesizer is to give you the capability to shape and control every aspect of a musical sound using the synthesizer’s controls. Therefore the ideal amplification system for synthesizers should introduce as little distortion or coloration as possible. For this reason, P.A. systems usually produce the cleanest sound with synthesizers. Likewise a bass guitar amplifier is probably the worst kind of amplification for synthesizers because bass guitar amps usually have poor high frequency response. Some lead guitar amps also have a lot of distortion and coloration. If you play your synthesizer through such an amp, your sounds will tend to be characteristic of the amplifier rather than the synthesizer. Sometimes, however, the combination of the synthesizer and an amplifier with a great deal of its own coloration will produce just the sound you might be looking for.

Also, don’t be afraid to use accessory devices, such as phasers, fuzz-wow pedals, equalizers and so forth with your Odyssey. You can get interesting results. The Odyssey can also be used as an accessory device for other electronic musical instruments through use of the external audio input jack.

# Let's Begin

By now your curiosity is probably beginning to exert itself, and you may wish to start playing immediately. In this case, simply turn to page 39, read the brief description of the control functions, and then set up any of the patches starting on page 43. While these patches provide some basic ideas of the vast potential that lies within the

Odyssey, you'll ultimately discover an ever greater number of new and exciting sounds and effects on your own.

If you prefer to systematically examine each control of your Odyssey before playing, continue on to the information which follows.



## HOW YOUR ODYSSEY WORKS

Generally speaking, all the electronic circuits in your Odyssey perform one of three basic functions:

1. Signal sources: the “raw” tones or noise which will ultimately be shaped into musical sounds.
2. Signal Modifiers: the “raw” sounds are passed through signal modifiers where the timbre (or tone quality) is changed to produce the desired sound, and
3. Controllers: devices which determine the operating characteristics of the signal sources and the signal modifiers. For instance, the keyboard is a controller which produces a voltage to tell the oscillator what pitch to create. Similarly, the ADSR envelope generator creates an attack and decay signal that controls the Voltage Controlled Filter (VCF) so that the final musical sound has an attack and decay.

All mechanical instruments work in a similar way. A violin, for instance, has a vibrating string which would be a signal source. The vibrating string corresponds to the oscillator in your Odyssey. The vibrations from the string are transmitted to the body of the violin which modifies

the sound of these vibrations. The body of the violin is actually a mechanical filter and corresponds to the Voltage Controlled Filter (VCF) on the Odyssey. It is the characteristic resonances of the body that give the violin its distinctive tone quality. The fingerboard, like the keyboard on your Odyssey, determines the pitch of the sound. The movement of the bow, like the ADSR Envelope Generator, determines the attack and decay characteristics of the sound.

Interconnecting the various functions shown in Figure A is known as creating a “patch.” The block diagram illustrated in Figure A is, of course, a violin patch. Similarly, it is possible to diagram any patch that you may play on the Odyssey. Actually, this visual representation of a patch permits you to better understand what functions of the synthesizer are being employed and how each function contributes to the finished sound.

FIGURE A.

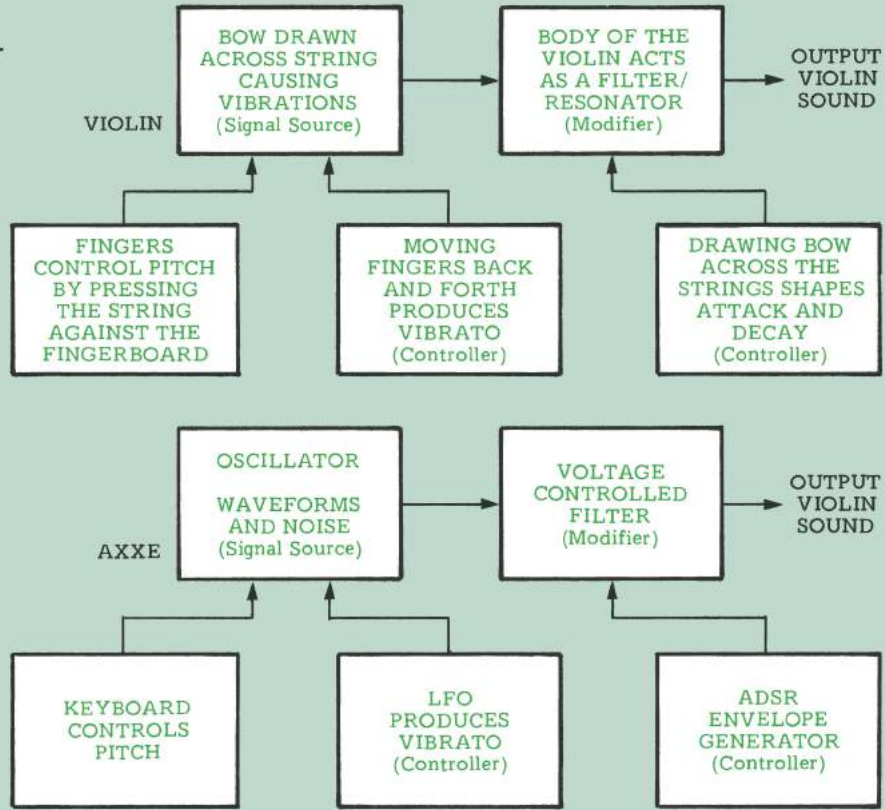

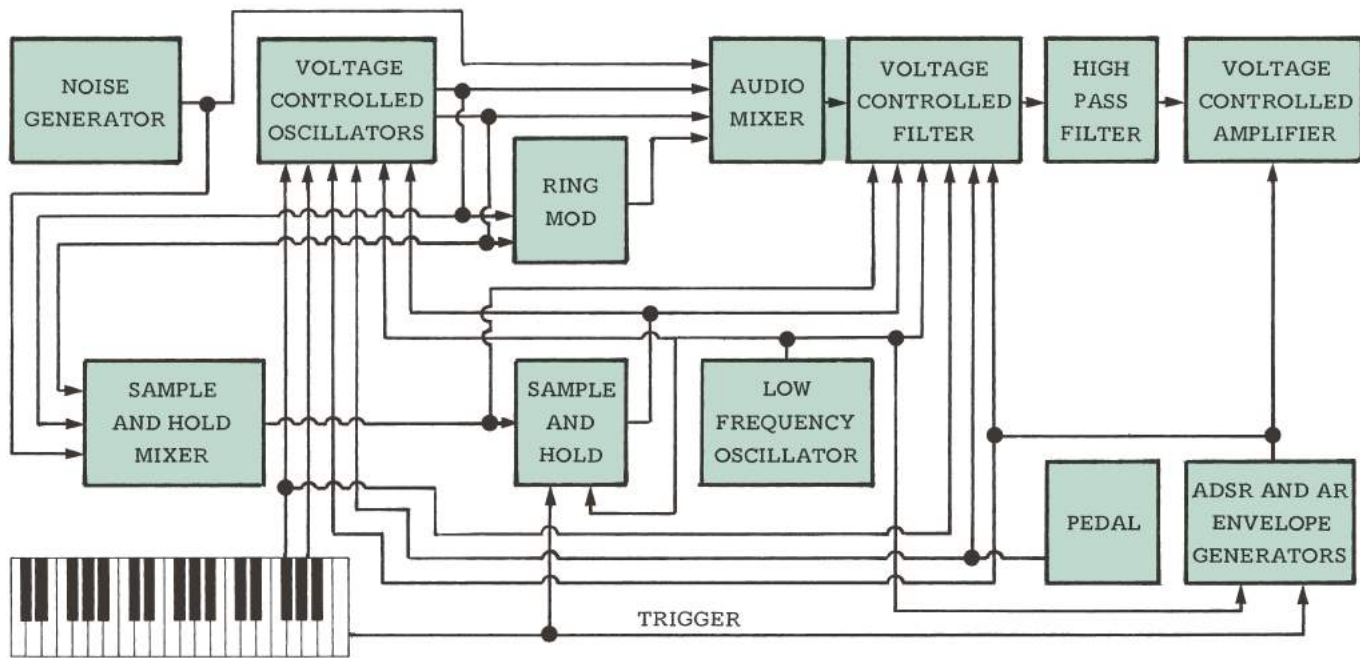

FIGURE B.

The figure above is a block diagram of all the functions and internal connections in your Odyssey. As we proceed with our discussion on the Odyssey's functions, you will be able to see exactly how the different functions interact.

The Voltage Controlled Oscillator on your Odyssey produces electrical waveforms (saw-tooth, pulse, and square waves) which are used to create a wide range of sound timbres. If a signal generated by an oscillator has the same waveform as a sound created by a traditional instrument, both will sound the same.

Different waveforms have different sounds. Your Odyssey is capable of creating six basic waveforms, plus noise:

Sawtooth wave; full, brassy



Square wave; clarinet-like



Pulse wave; bright, nasal



Modulated pulse wave; chorus-like, rich



Sine wave; pure, whistle-like



Various phase-synced waveforms; bright, rich



# Sound Sources

## EXPERIMENT 1. LISTENING TO WAVEFORMS

1. Hook up your ODYSSEY to a speaker and amplifier as described on page 3. For the time being, set all tone controls on your amplifier for "flat" response.
2. Set all the controls on your ODYSSEY to match the positions shown in Figure C. Double check the settings before proceeding.

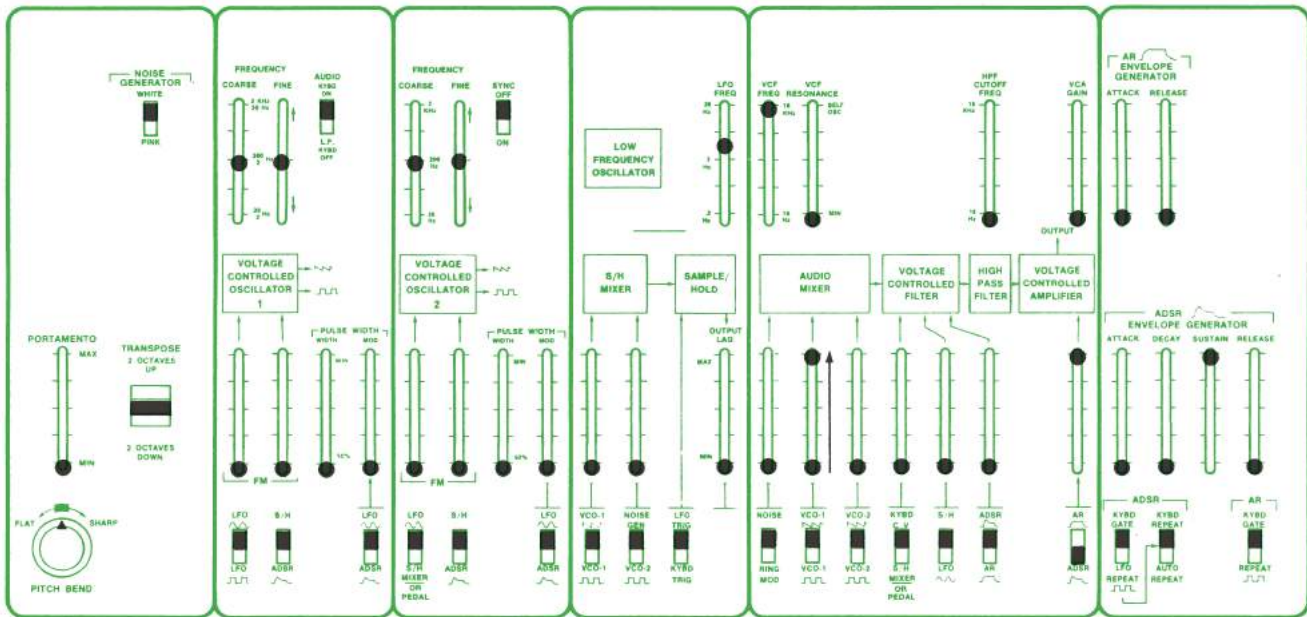
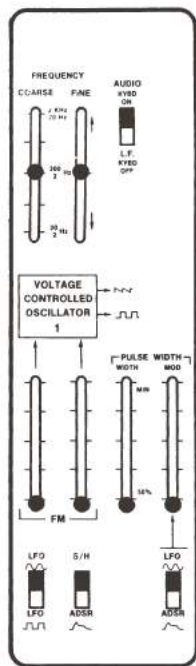

FIGURE C

FIGURE D.



3. The controls on your ODYSSEY are now set so that you will be able to hear the different “raw” waveforms from the ODYSSEY’S VOLTAGE CONTROLLED OSCILLATOR (VCO) whenever you play the keyboard. Locate the three slide controls under the AUDIO MIXER (white, green, and blue).
4. Raise the blue slider under the AUDIO MIXER and play a few notes on the keyboard. The sound you are hearing is the raw, unprocessed sawtooth wave.
5. The pitch of this tone can be varied manually through use of the COARSE and FINE tuning sliders. These sliders are located in the part of the panel marked VOLTAGE CONTROLLED OSCILLATOR 1 (Figure D).

Hold a note down and push each of these sliders through its range. The COARSE slider allows tuning through a good part of the audio spectrum, while the FINE tuning slider allows a range of about one octave. When you are tuning the voltage controlled oscillators, either to one another or to another musical instrument, you will first tune the COARSE slider to the approximate range, and then use the FINE slider to find the pitch exactly.

6. The slide switch next to the tuning sliders lowers the frequency of VCO 1 by a factor of about one hundred when this switch is placed in its L.F. position. This is far below the range of human hearing; consequently you will not hear any continuous tone but only a more or less rapid series of clicks. The rate of this low frequency signal is not controlled by the keyboard, but can be varied by adjusting the tuning sliders.
  
7. Return the tuning sliders to the center of their range, and set the slide switch back to the audio range. Now change the slide switch under the blue slider of the AUDIO MIXER to the bottom position. Again, play the keyboard and you will now be hearing the sound of a raw unprocessed square wave. Notice how the square wave, especially at low pitches, has a hollow, clarinet-like sound.
  
8. The square wave on your ODYSSEY can be turned into another waveform called a PULSE WAVE by raising the blue slider labelled PULSE WIDTH located under the VOLTAGE CONTROLLED OSCILLATOR 1 box. Raise this slider to the halfway mark and again play on the keyboard. Notice how the pulse wave sounds brighter, more nasal, than the square wave.

9. An even narrower pulse wave can be created by raising the PULSE WIDTH slider all the way to the MIN marking. This waveform is very buzzy and thin. At the MIN marking, the top part of the pulse waveform is only about five percent of the total waveform. A square wave, as its symbol implies, has a top part of its waveform that is exactly fifty percent of the total waveform.

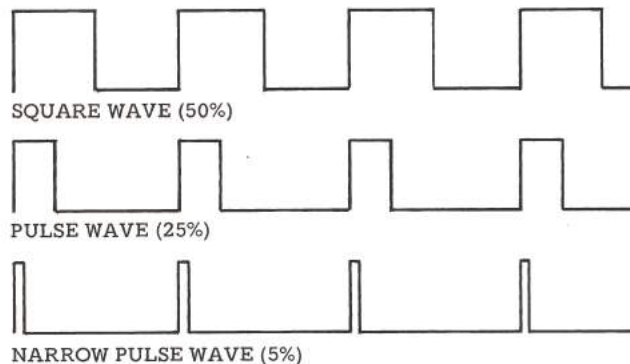

FIGURE E.

## EXPERIMENT 2. PULSE WIDTH MODULATION

1. Lower the PULSE WIDTH control slowly thereby gradually increasing the width of the pulse wave until it becomes a square wave again with the PULSE WIDTH slider all the way down.
2. If you move the PULSE WIDTH control up and down while holding down a low note, you will hear that the changing pulse width creates a kind of chorus-like effect. The faster you move the PULSE WIDTH control, the more pronounced the effect. By changing or “modulating” the pulse width while you play, you are creating another waveform called the “MODULATED PULSE WAVE.”
3. The ODYSSEY has special PULSE WIDTH MODULATION controls that facilitate the generation of the modulated pulse waveform. Bring the blue PULSE WIDTH control all the way down, and raise the pink LFO PULSE WIDTH MOD control all the way up. Play the keyboard and you will hear a sound which is similar to the effect you created when you moved the pulse width control by hand in step 2. If you lower the pink LFO PULSE WIDTH MOD slider, the effect will diminish and finally disappear.

Notice that the pink LFO FREQ control to the right of the Low Frequency Oscillator box changes the speed of the chorus-like sound.

4. Experiment with different combinations of settings of the blue PULSE WIDTH control, the pink LFO PULSE WIDTH MOD control, and the pink LFO FREQ control.

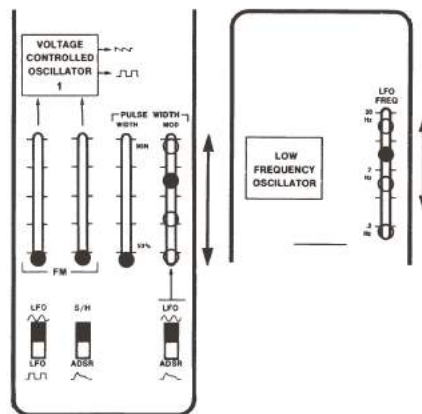

FIGURE F.



### EXPERIMENT 3. PHASE SYNCHRONIZATION

1. Now look at the part of the panel marked VOLTAGE CONTROLLED OSCILLATOR 2. VOLTAGE CONTROLLED OSCILLATOR 2 is exactly like VCO 1 except for two things:
  - VCO 2 does not have a low-frequency operating range.
  - VCO 2 can be SYNCHRONIZED to VCO 1.

Lower the blue slider under the AUDIO MIXER box and raise the green slider. Now play the keyboard. You are now listening to VCO 2.

2. VCO 2 can be switched between sawtooth wave and square wave the same as VCO 1, and the frequency of VCO 2, when it is not phase-synchronized, can be varied in the same manner. VCO 2 also has pulse width modulation like VCO 1. Try the experiments that were done above on VCO 1 with VCO 2.
3. Phase-synchronization of the two oscillators is accomplished by the switch at the top right of VCO 2 labelled SYNC OFF/ON.

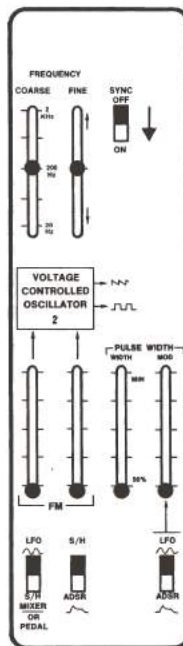

FIGURE G

STEP 3.

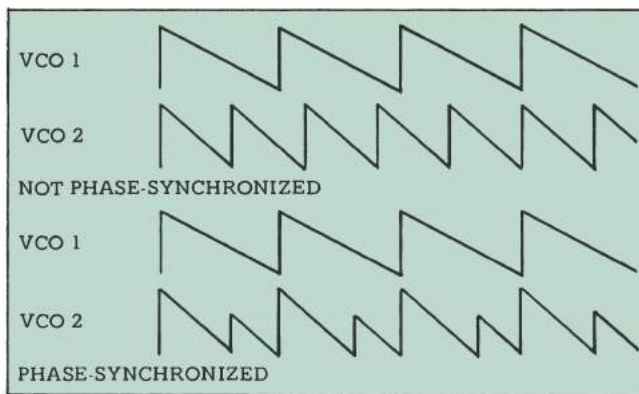

FIGURE H.

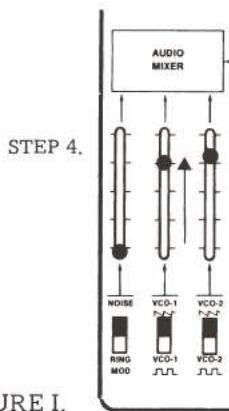

FIGURE I.



FIGURE J.

When this switch is on, the audio signal from VCO 2 is forced to conform to the frequency of VCO 1. This is done by causing the waveform of VCO 2 to begin again, or restart whenever VCO 1 begins another waveform. This is shown for sawtooth waves in Figure H, and the same principle applies to square and pulse waveforms as well.

It is for this reason that the harmonic sound of VCO 2 will vary as the COARSE and FINE frequency sliders for VCO 2 are changed, even though the basic frequency of the waveform does not change (it remains the same as VCO 1).

You can hear this effect in its raw form by setting VCO 1 to some relatively low audio frequency (near the 100 Hz mark) and slowly moving the coarse tuning control of VCO 2 through its entire tuning range from bottom to top after turning the PHASE-SYNCHRONIZATION Switch of VCO 2 on. Experiment also with changing the frequency of VCO 1 while leaving VCO 2 in about the middle of its range. Some of the patches make use of this spectacular sound, unique to the ODYSSEY.

4. At this point, too, with the SYN SWITCH off, you should practice tuning VCO 1 and VCO 2 to various musical intervals by opening both the second and third sliders under the audio mixer.

## EXPERIMENT 4. NOISE

1. Lower the blue and green sliders under the AUDIO MIXER box and raise the white slider. Play a few notes on the keyboard and listen to the sound. You are hearing what is known as WHITE NOISE. This noise contains all frequencies in the audio spectrum in equal amounts, and is harmonically identical to the noise you hear between stations on the FM radio band.
2. There is a noise generator switch located in the upper left hand corner of the ODYSSEY. Change the position of this switch to PINK and again play a few notes on the keyboard. Whereas WHITE NOISE contains equal amplitudes of each frequency, PINK NOISE contains equal energy of each frequency. Physically, this means that the higher frequencies are present at lower volumes than the lower frequencies. PINK NOISE is the most musically useful kind of noise because it sounds balanced to the ear, neither too high and hissy, nor too low and rumbling. You will see later how to use the other functions on the ODYSSEY to turn noise into a wide range of exciting sounds.

## EXPERIMENT 5. FREQUENCY MODULATION

The pitch of the Voltage Controlled Oscillator (VCO) on your ODYSSEY is controlled by the keyboard. You know this from the previous experiments and you can also see that the keyboard is connected to the VCO on the block diagram, page 9. As you will now experience, you can also change the pitch or frequency of the VCO by bringing in "control voltages" from other devices on the ODYSSEY.

1. To begin experimenting with Frequency Modulation, again set the controls exactly as shown in Figure C.
2. Raise the blue VCO 1 slider under the AUDIO MIXER.  
You will now hear the sawtooth wave again when you play the keyboard.
3. Hold down a note on the keyboard and slowly raise the pink LFO control next to the TRANSPOSE

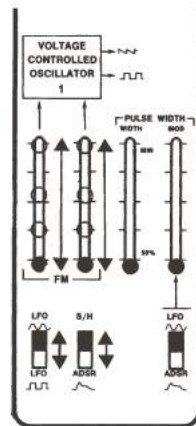





FIGURE K.

SWITCH. Notice that a slow vibrato is introduced that becomes deeper as you raise this control.

4. With this LFO control up about 1/4, adjust the LFO FREQ control and observe how the vibrato rate can be changed from very slow to very fast. About 3/4 should provide a pleasing vibrato rate.
5. Change the first slide switch from LFO  to LFO . Instead of a smooth vibrato, the LFO  produces a trill. Notice that as you raise this slider, the bottom note of the trill stays the same and the top note moves depending on the setting of the slider. Try tuning the trill for different intervals, like a fifth, octaves, etc. If you increase the LFO SPEED control, the trill can become a useful musical timbre, especially when the trill is tuned to simple intervals, like octaves.
6. When you have finished experimenting with trills, bring the LFO FM slider back down.
7. Now raise the white slider under the S/H Mixer box. While holding down a note on the keyboard, slowly raise the yellow S/H control under the VCO. Notice that this control causes pitch of the VCO to jump around in a completely random manner. The higher

you raise the yellow S/H slider, the wider the pitch variations. At least one S/H Mixer slider must be raised in order for the yellow S/H control to be activated.

8. Bring the yellow S/H slider back down, and lower the white S/H Mixer slider.
9. Now set the slide switch under the yellow knob to the ADSR position, and then raise the yellow slider. Notice how the pitch rises. Leave this control set so that you have raised the pitch about an octave.
10. Now bring up all the way the four red ADSR ENVELOPE GENERATOR CONTROLS (located in the lower right hand corner of the panel).
11. Again play on the keyboard. You will hear the pitch of the sound rise and fall each time you hit a key. The settings of the ADSR controls will determine the speed of the pitch change. You will learn more about these controls when you get to the section on "Controllers."

# Modifiers

Modifiers are electronic devices that can process a signal and change its sound. Consequently a modifier must have an input and an output. A tone control on a hi-fi set is a simple modifier since it changes the nature of the sound signal that passes through its circuitry.

The ARP ODYSSEY contains four modifiers, the Voltage Controlled Filter (VCF), the Voltage Controlled Amplifier (VCA), the High Pass Filter (HPF), and the Ring Modulator. Any signal that is introduced into the AUDIO MIXER, i.e., Noise, VCO or VCO must pass through the VCF, HPF and the VCA before reaching the output of the ODYSSEY.

## EXPERIMENT 1. RING MODULATION

Lower the blue and green sliders under the AUDIO MIXER BOX, and raise the white slider again. Change the position of the slide switch under the white slider from Noise to RING MOD. Make sure that the PHASE SYNC switch for VCO 2 is off. Play a few notes on the keyboard and listen to the RING MODULATOR. While you are listening to it you should think of the block diagram shown in Figure L. The RING MODULATOR has no controls of its own. It produces, from the pulse outputs of VCO 1 and VCO 2, a single complex output signal which contains all the sums and differences of the two oscillator frequencies. This means that:

- The raw sound produced from the ring modulator depends entirely on the tuning of VCO 1 and VCO 2; and to a lesser extent on

the pulse width settings for each one. Experiment with these. Note in particular that sounds from the RING MODULATOR do not necessarily have any standard musical pitch in relation to the pitch of either oscillator. (Unless they are synchronized by the SYNC switch on VCO 2; try that).

- The overtones of the RING MODULATOR signal will not necessarily conform to the standard harmonic series. They may be extremely complex, like those of a bell, chimes, gongs, and other metallic or percussive sounds. All of these, in fact, can be simulated by further modifications of a suitable ring modulator signal. Some of the patches illustrate this.

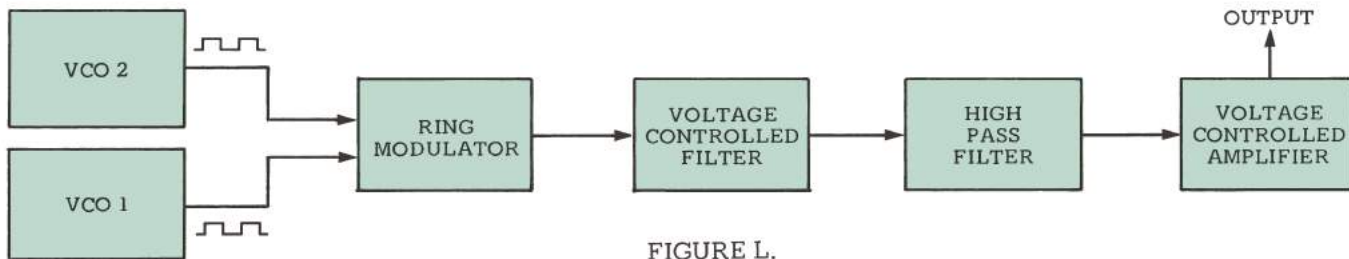
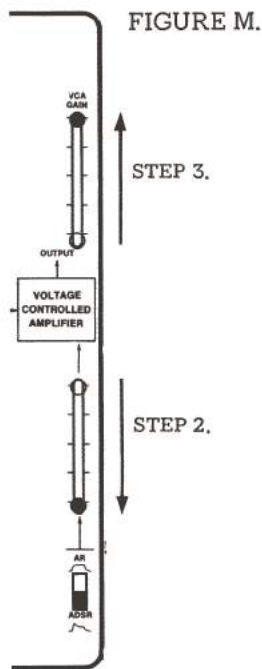

FIGURE L.

## EXPERIMENT 2. THE VCA

1. Set the controls on your ODYSSEY to match the settings in Figure C. This time, raise the white NOISE slider under the AUDIO MIXER. As before, when you hit a note on the keyboard, you will hear the noise sound.
2. While holding down a note on the keyboard, gradually lower the red ADSR slider under the VCA. Notice that this slider acts like a volume control. Bring this control all the way down and the sound will completely disappear.
3. With this ADSR control all the way down, slowly raise



the black VCA GAIN control. Notice how this control also acts like a volume control. The difference between the operation of the ADSR slider and the VCA GAIN control is obvious. The ADSR control depends on playing the keyboard. The VCA GAIN control has nothing to do with the keyboard. The VCA GAIN control allows a certain amount of signal to pass through the VCA at all times. Bringing up the red ADSR control will let the signal pass through only when the keyboard is used.

Actually, to be more specific, the ADSR slider lets the voltage produced by the ADSR ENVELOPE GENERATOR to “open” the VCA and let signal pass through. The settings of the ADSR ENVELOPE GENERATOR controls will determine the speed with which the VCA opens and closes. Experiment with the four ADSR ENVELOPE GENERATOR controls to observe this effect.

### EXPERIMENT 3. THE HIGH PASS FILTER

The HIGH PASS FILTER (HPF) is another signal modifier. It attenuates frequencies below the setting of its HPF cutoff frequency slider. It is useful in eliminating “Boominess” from low bass notes, and in simulating certain instrumental sounds. The HPF is not voltage controlled. Try moving the HPF control slowly over its range while holding down a low note on the keyboard.

FIGURE N.



### EXPERIMENT 4. THE VCF

The Voltage Controlled Filter (VCF) is the most important modifier on any synthesizer. The VCF is responsible for taking the raw signals from the VCO, Ring Modulator, and the Noise Generator and shaping them into useful musical sounds.

The VCF in your ODYSSEY is technically called a “low pass filter.” Low-pass means that the filter will pass all audio frequencies below a certain point (called the “cut-off point”) and will filter out all frequencies above this point.

1. Set the controls on your ODYSSEY according to Figure O. In this setting, the sawtooth wave from the VCO is entering the VCF through the AUDIO MIXER. Also, the VCA GAIN control is raised so that any signal passing through the VCF will be heard.
2. Play a note in the middle of the keyboard. You don't have to hold it down. Slowly raise the VCF FREQ control and listen to the effect. Notice how the sound gets brighter and louder as you raise this control. It does so because you are raising the cut-off frequency of the filter, thereby letting more and more high frequencies pass through.



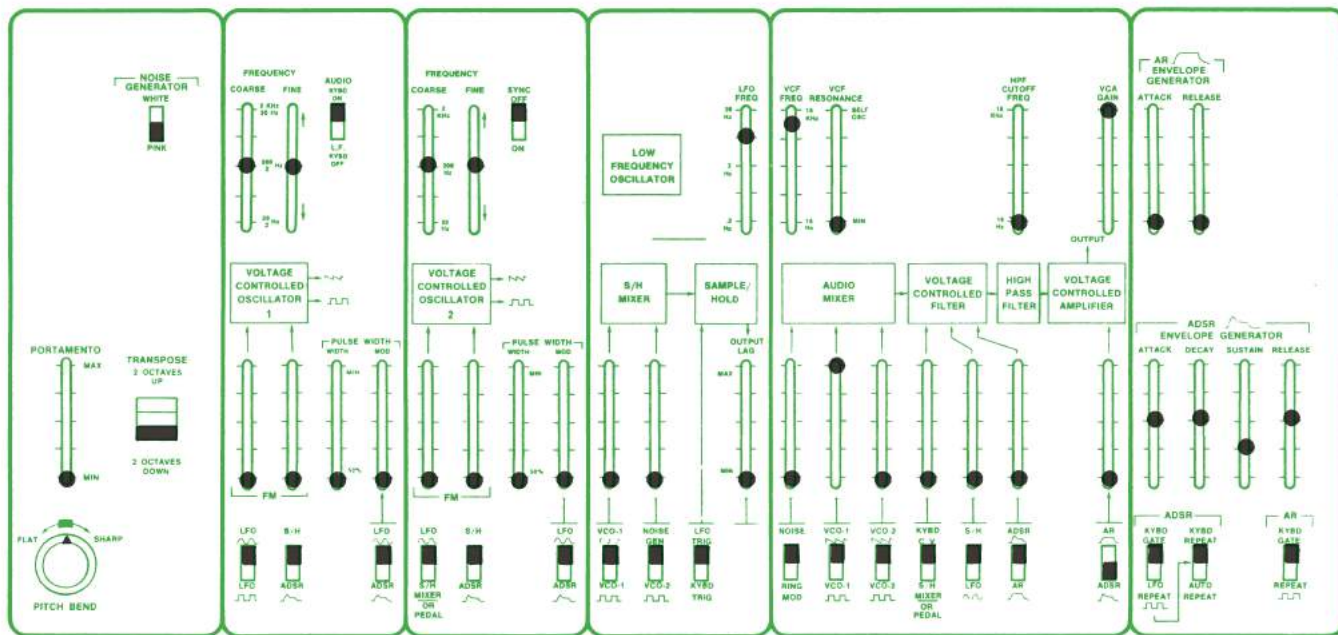

FIGURE O.

3. Slowly lower the VCF FREQ control. The highs will fade and finally the whole signal will be filtered out.
4. Lower the blue VCO 1 slider under the AUDIO MIXER and raise the white NOISE slider. Again open

and close the VCF by raising and lowering the VCF FREQ control.

5. Notice how the noise can be made to sound like surf by opening and closing the filter slowly. Raise the

FIGURE P.

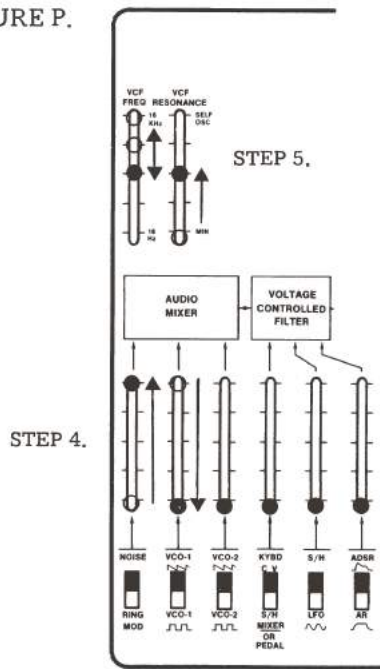

RESONANCE slider about half way up and try the same experiment. Notice how the noise now takes on a whistling quality. This pitch-like whistling is caused by the resonance of the filter. Resonance emphasizes a narrow band of frequencies just at the filter cutoff frequency. The more resonance you add, the more emphasis, and consequently the more pitched the sound becomes.

6. Lower the noise slider and listen again to the VCO sawtooth wave. Again move the VCF FREQ control up and down slowly with different settings of the RESONANCE control. Notice that when the resonance is between the 1/2 and 3/4 marks you can actually hear the individual harmonics of the sound as you slowly sweep the VCF FREQ up and down.
7. If you leave the RESONANCE control about half way up, and sweep the VCF FREQ up and down, you can create a “wow” type of sound. Leave the VCF FREQ control all the way down and raise the red ADSR slider under the VCF all the way up. When you hit a key on the keyboard, the ADSR ENVELOPE GENERATOR produces a signal which

will open and close the VCF automatically, producing a “wow” sound. Experimentation with the setting of the ADSR slider will show the similarities between the response of this control and the response of the ADSR slider under the VCA.

8. Lower the RESONANCE slider and experiment with the different settings of the ADSR slider under the VCF. Try changing the settings of the four ADSR ENVELOPE GENERATOR controls.
  
9. Lower the ADSR control again, and set the VCF FREQ control about half way up. Now, set the switch under the yellow slider to LFO and raise the yellow LFO  slider under the VCF. Notice the tremolo effect that is created. Lower the LFO slider and increase the LFO SPEED until you achieve a good tremolo sound.
  
10. Lower the LFO slider, and raise the black slider labeled KYBD CV S/H under the VCF. Normally this slider will allow you to control the VCF from the keyboard.

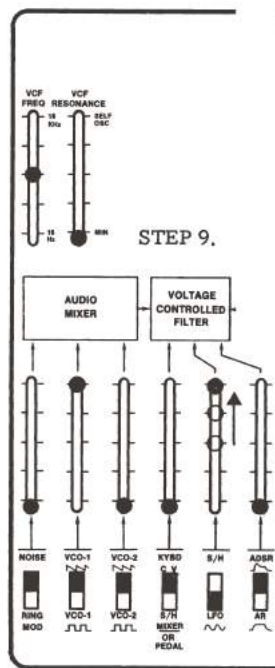
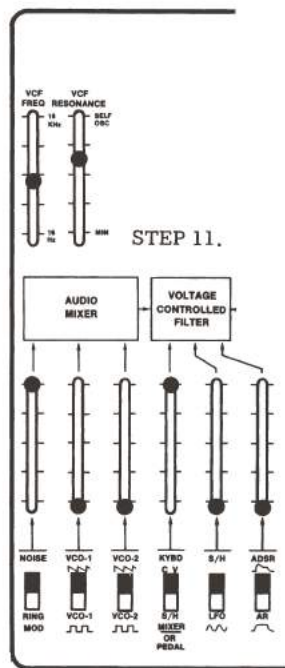

FIGURE Q.

FIGURE R.



11. Let's try controlling the VCF with the keyboard. Set the controls on the panel as above. Now when you play on the keyboard, the pitch of the filtered noise will follow the note played on the keyboard. If you lower the black KYBD slider under the VCF, the keyboard will have no effect on the pitch.
12. Raise the yellow slider all the way up again, and raise the white slider under the S/H Mixer box. Play the keyboard. Notice the random changes in the filter frequency.
13. Plug the pedal into the appropriate jack on the back of your ODYSSEY. When the pedal is plugged in, the S/H Mixer is disconnected from the VCF. Set the switch under the black slider to the Pedal position. The PEDAL can now be used to open and close the VCF. The range of the pedal will be determined by the setting of the black slider under the VCF.

14. The VCF can also function as an oscillator. Raise the yellow slider under the VCF all the way.
15. All three sliders under the AUDIO MIXER should be down. Turn the RESONANCE all the way up and tune the resulting tone with the VCF FREQ control. Set the switch under the black slider back to the KBD position. You can now hear a pure sine wave generated by the filter.

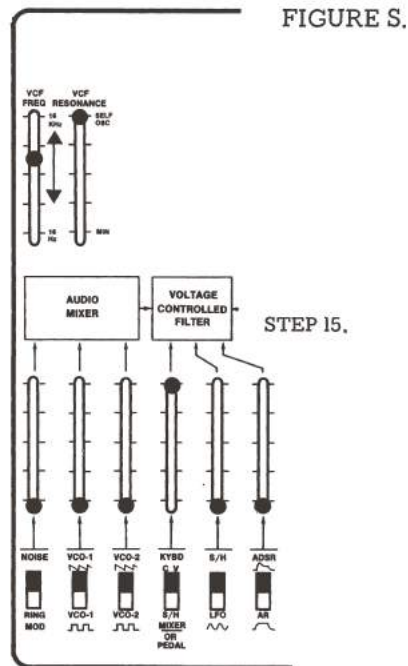

Controllers are devices on the synthesizer which are used to create electrical signals which in turn control modifiers and sources on the synthesizer. For instance, the most obvious controller on the ODYSSEY is the keyboard. The keyboard produces a voltage which controls the VCO and can control the VCF. Other controllers on the ODYSSEY are the sample and hold, ADSR ENVELOPE GENERATOR, HPF, LFO, PITCH BEND CONTROL, and FOOTPEDAL.

By this time you have had an opportunity to experiment with each of these controllers, so let's just review the functions of each of the controllers.

# Controllers

## KEYBOARD AND PEDALS:

The KEYBOARD produces two CONTROL VOLTAGES. These voltages are the same if none or one key is depressed on the keyboard. (If no keys are depressed on the keyboard, the control voltages correspond to the last key played.) If two or more notes are depressed, the first control voltage corresponds to the lowest key depressed, and the second control voltage corresponds to the highest depressed.

The first control voltage is always connected to VCO 1, unless VCO 1 is set to the L.F. mode, in which case the keyboard is disconnected from VCO 1. The second control voltage is always connected to VCO 2. When VCO 2 has SYNC switched on, the keyboard is still connected to VCO 2, although in this case it does not directly control its frequency, but rather its harmonic content, as do the tuning sliders for VCO 2 in this case. (Try it.)

The first keyboard control voltage can also be connected to the VCF by raising the appropriate slider under the VCF. This was investigated during the experiments with the VCF.

It is important to know that the ODYSSEY has a built-in memory, which holds the last note played on the

keyboard. This keeps the pitch information around during the RELEASE cycle of the AR and ADSR envelope generators, as we shall see.

The keyboard on the ODYSSEY has several controls associated with it. These include the PORTAMENTO slider and PORTAMENTO SWITCH. The TRANSPOSE SWITCH will shift the pitch of the keyboard up or down exactly two octaves. The PITCH BEND control will be discussed in a separate section.

PORTAMENTO is a "sliding effect." Set up your ODYSSEY as shown in Figure M. Raise the ADSR control under the VCF. As you play on the keyboard, hold down the PORTAMENTO pedal, raise the PORTAMENTO slider and listen to the resulting effect. The foot switch supplied with your ODYSSEY is used to turn on the PORTAMENTO. Thus you can set the PORTAMENTO slider for a certain glide speed and then turn it on and off with the foot switch.

When the foot pedal is plugged into the back of your ODYSSEY, VCO 2 and the VCF can be controlled by it. (The signal from the S/H Mixer is automatically disconnected by inserting the foot pedal jack as explained earlier.) Several of the patches make use of the foot pedal for wah-wah and other effects.

## ADSR AND AR ENVELOPE GENERATOR:

Each time a note is pressed on the keyboard, the keyboard generates a "trigger" signal that initiates an attack from the ADSR. A complete cycle of the ENVELOPE GENERATOR looks like this:

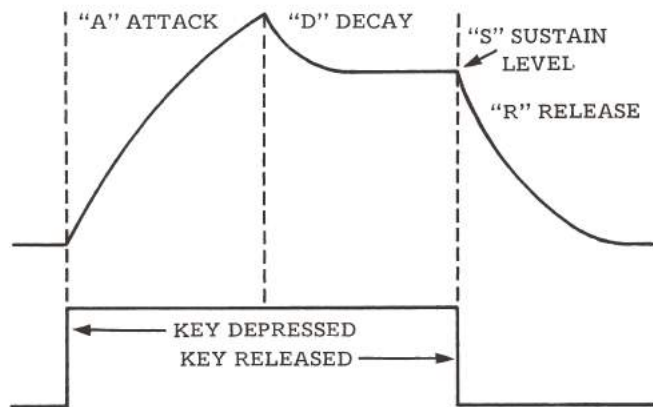

When a key is depressed, the output of the ADSR rises at a speed determined by the setting of the "ATTACK" control. This attack is represented above by the letter "A." When the attack has reached its peak, it automatically turns around and begins heading down again at a rate controlled by the "DECAY" control. This part of the cycle is represented as the letter "D." The

Output of the ADSR ENVELOPE GENERATOR will eventually reach the Sustain Level "S" and stay there until the keyboard is released. Upon release of the key, the output of the ADSR will drop back down to zero at a rate determined by the setting of the Release Control. This release portion of the cycle is represented by the letter "R."

The AR envelope generator is just like the ADSR generator except that there is no decay, so that the sustain level is the maximum level. This gives the same effect as the ADSR generator with the "Decay" control at minimum and the "Sustain" control at maximum. A complete cycle looks like this:

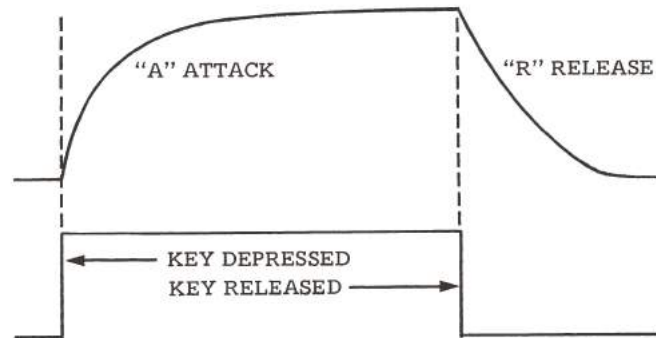



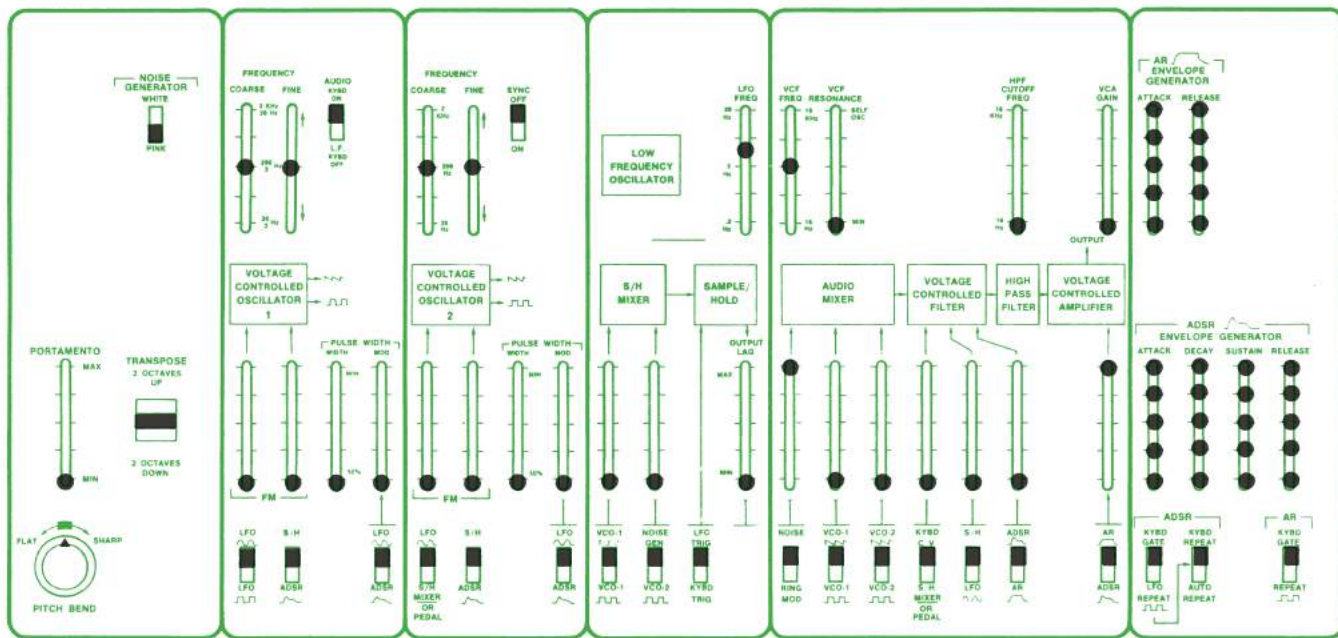

FIGURE T.

With your ODYSSEY controls set as in Figure T, depress any key on the keyboard. Raise the attack slider on the AR generator a little way and depress a key again. Continue to do this, each time raising the attack control a little more until it is all the way up. Then move it down

again and repeat the whole procedure using the release slider.

Now experiment with VCA control by the ADSR generator; move the selector switch under the VCA

FIGURE U.

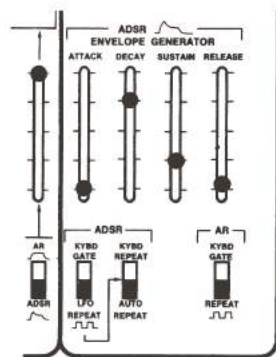

FIGURE V.

control attenuator down and try various settings of the four ADSR controls.

By closing the VCF freq slider and opening the third attenuator under the VCF all the way as in Figure U, you can give yourself a similar introduction to ADSR and AR control of the VCF. Experiment too with various combinations of the VCF freq and control attenuator settings, and with various mixes (by means of the input attenuators to the audio mixer) of signals from VCO 1 and VCO 2.

Up to now you have been triggering the envelope generators only from the keyboard. By means of the three switches at the bottom right of Figure V, you can also trigger the envelope generators with the LFO. Move all three switches down and set the other controls of your ODYSSEY for AR or ADSR control of the VCF or VCA as in Figure V. Now try different settings of the LFO freq slider from low to high. With the first switch down and the second switch up, a series of events will be produced (triggered) by the LFO, but only when a key is depressed. This is useful in simulating banjo-picking and strumming.

## SAMPLE AND HOLD

The sample and hold mixer (S/H mixer) selects and combines signals to be fed to the sample and hold circuit. These signals can also be routed to control VCO 2 and the VCF. Under each of these two functions is a switch labeled "S/H mixer or pedal." When the foot pedal is plugged into the Odyssey, the lower position of these switches selects control by the pedal; if the foot pedal is disconnected from the back of the Odyssey, the same switch position selects control by the output of the S/H mixer.

The sample and hold circuit is a controller; it is used only to control VCO 1, VCO 2, and/or the VCF. In order to hear what it does listen first to VCO 2 as you have done before and then experiment with the controls indicated in Figure W.

By "sampling" at a given instant the signal voltage from the S/H mixer, the sample and hold circuit produces a series of voltage levels. If these in turn are used to control a VCO, the result is a series of pitches. The switch under the sample and hold circuit selects either the LFO or the keyboard as a triggering source. If the keyboard is selected (Figure X), then a new sample will be taken every time you press a key. Using this with the S/H going into the

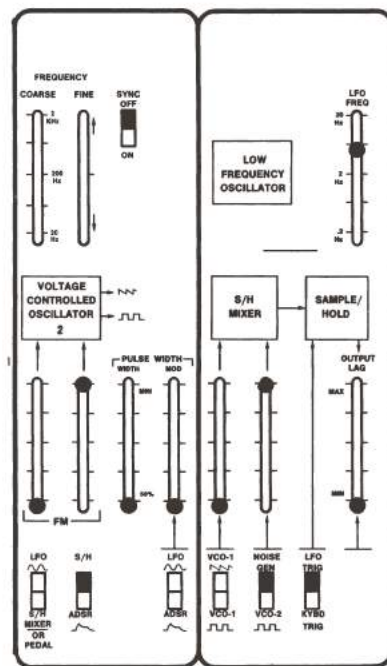

FIGURE W.

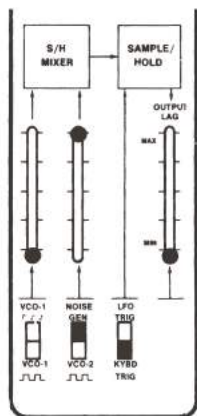
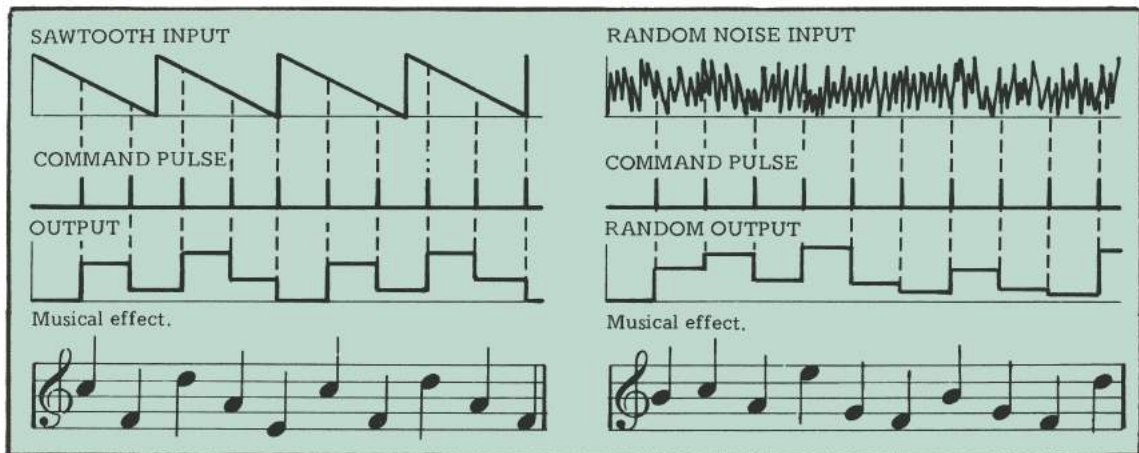

FIGURE X.



VCF can give you random timbres on each note. If the LFO is selected, then new samples will be taken at regular intervals corresponding to the frequency setting of the LFO.

When the signal sampled is primarily noise, the output voltage levels will be random and so of course will be the pitches produced from VCO 2; but if the signals being sampled are regular and periodic (any combination of the VCO 1 and VCO 2 signals), then the output from the

sample and hold circuit will tend to be a repeating pattern also. It may be an extremely complex one, or it may be extremely simple. For an example of a simple one, switch VCO 1 sawtooth into the S/H mixer. Use the sample and hold output to control VCO 2 and listen to VCO 2 through the audio mixer. Set the LFO freq to about halfway up, and the VCO 1 freq at about 2 Hz. You should hear a descending “staircase” of pitches, like a scale passage or an arpeggio (Figure Y). Speed up VCO 1 freq and hear the repeating patterns.

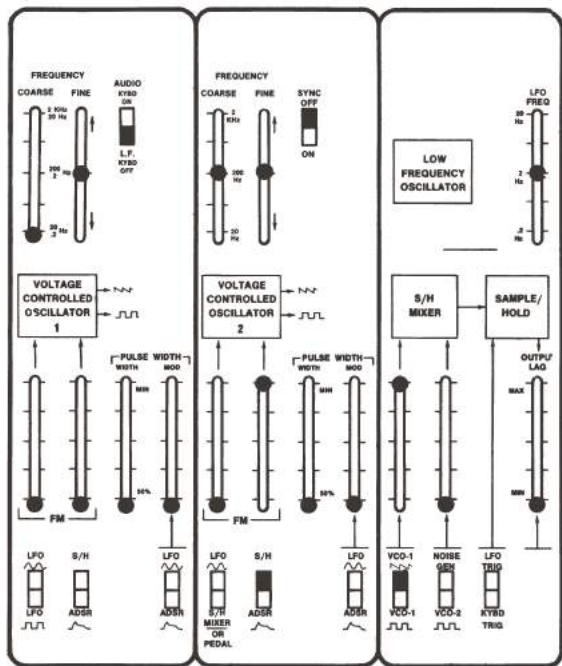

FIGURE Y.

FIGURE Z.



The output lag slider (Figure Z) “smooths out” sudden changes of voltage from the sample and hold circuit. With the same patch you have been listening to, move the slider slowly from “min” to “max” and back again.

## LOW FREQUENCY OSCILLATOR

The LFO on your ODYSSEY, as you have already seen, is used to create voltages which produce vibrato, trill, tremolo, and other effects when these voltages are applied to the VCO or VCF. The LFO produces both a sinewave output and a square wave output. The sinewave output is used to create vibrato and tremolo effects and the square wave is used to create trills. The LFO is also hooked up to the ADSR ENVELOPE GENERATOR, via the REPEAT SWITCHES.

## PITCH BEND CONTROL

The Pitch Bend knob is a live performance control for bending notes. It also extends the tuning range up to an extra octave beyond normal. This control permits you to realistically “bend” pitches in order to recreate the kinds of effects and create sounds that are not imitative of traditional instruments.

When recreating the effect of the pitch bend of traditional instruments, however, limit the pitch deviation to approximately one half-step. This is the most useful and common effect employed by guitarists, including those who work with rock groups. Notice that the normal position for the pitch bend knob is in the center of a “dead zone” where turning the knob slightly either way results in little or no pitch change. This feature lets you “feel” the normal position while playing, without having to look at the panel.

By taking advantage of the fact that the range of this now is exactly up or down an octave, you can use the PITCH BEND CONTROL as an auxiliary TRANSPOSE switch, or you can use it as a guitar “string pull” effect with a hard stop when the instrument is exactly in tune by turning the switch all the way to the left and playing an octave higher. This is very similar to a “Tremolo Bar” on a guitar, although on both instruments actual change is in frequency.

## EXTERNAL AUDIO INPUT

On the back of your ODYSSEY you will see a jack labeled "EXTERNAL AUDIO INPUT." This jack is used to bring an external signal, such as the output of an organ, electric piano, other synthesizers, etc., into the Audio Mixer and VCF in your ODYSSEY. The EXTERNAL AUDIO INPUT has a fixed sensitivity. The sensitivity is adequate for use with most electronic instruments. However, some very low level signals, like dynamic microphones and low level guitar pickups, may have to be preamplified before entering the ODYSSEY. Many guitar amplifiers have a separate preamp output that can be used for this purpose.

Once an external signal has been brought into the ODYSSEY, it can be processed through the VCF. The footpedal is especially useful in processing external signals since the VCF can be made to perform like a wah-wah pedal, with adjustable range and resonance.

At the same time you are processing an external signal, you can also add in signals from the VCO's and noise generator, so it is possible to create a rich and complex texture by combining both the external signal and a signal generated by the ODYSSEY VCO's or NOISE GENERATOR, and then filtering the combined signal with the VCF.

## INTERFACE JACKS

Your ODYSSEY is one member of a whole family of ARP synthesizers and synthesizer accessories. As such, it is equipped with input and output jacks that allow your ODYSSEY to control other ARP synthesizers or to be controlled by other ARPs. For instance, you can use two ODYSSEYs together and play both of them from one keyboard. Or you can hook up your ODYSSEY to control an AXXE, LITTLE BROTHER, or 2600 model. Similarly, if you already own a 2600 or String Ensemble, you can remotely slave your ODYSSEY to the 2600's keyboard. The possibilities created by the ARP INTERFACE JACKS are endless.

If you wish to hook up two ODYSSEYs in a master-slave relationship where one is controlled by the other's keyboard, simply connect the jacks labeled "CV OUT," "CV IN," "GATE IN," and "TRIG IN" jacks on the Slave.

If you wish to slave more than one ODYSSEY from another, the second slave ODYSSEY is hooked up to the first slave in the same way that the first is hooked up to the master, i.e., CV, GATE, and TRIG OUT to CV, GATE, and TRIG IN. See diagram on the following page. Generally the Audio Outputs of Little Brothers are connected to the input of some other unit.

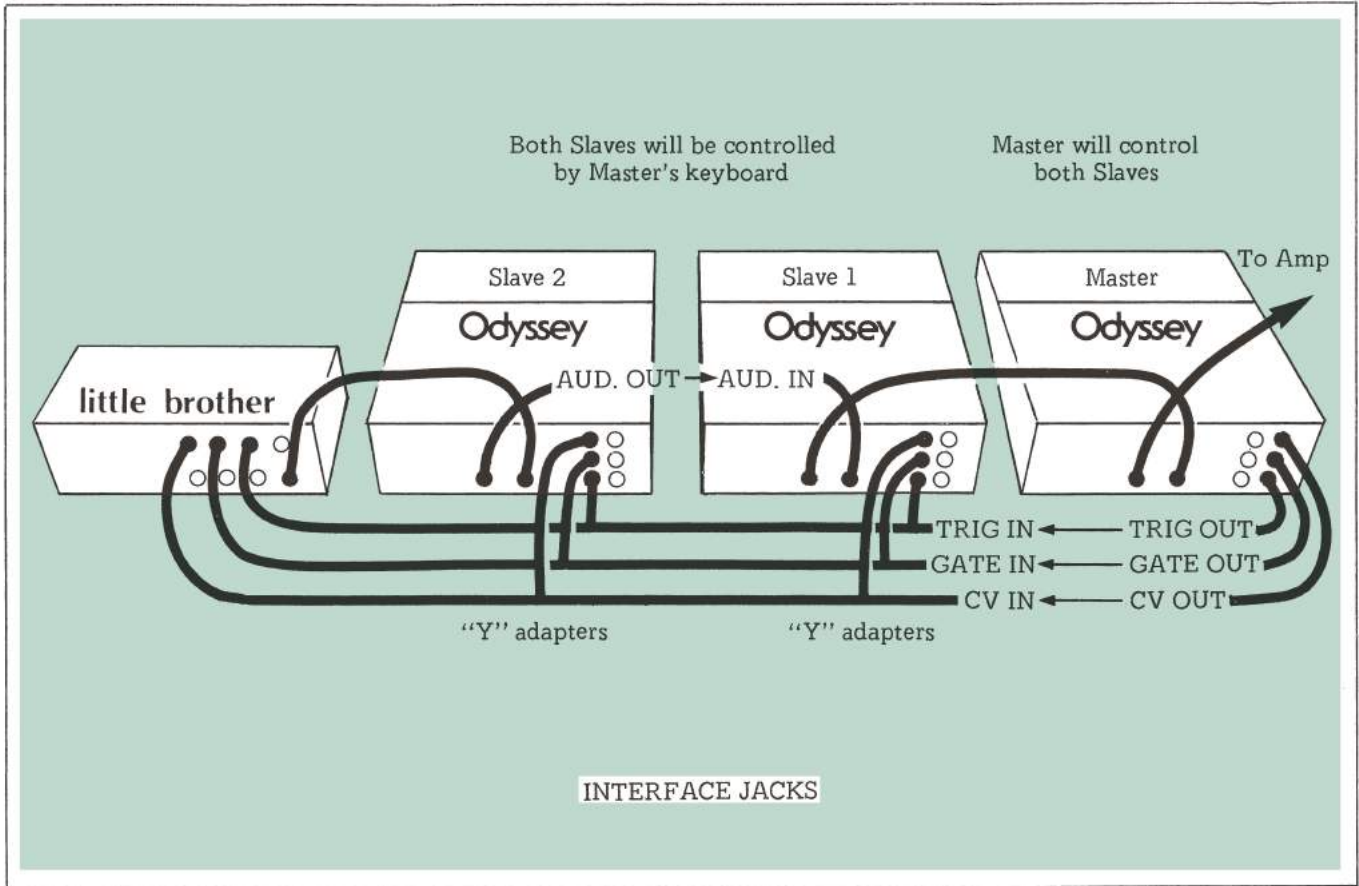



## PANEL CONTROL DESCRIPTION CHART

**Noise Generator:** The noise generator produces white and pink noise which is used in creating unpitched effects like thunder, surf and wind.

**Portamento:** The Portamento allows you to glide from one note to the next. This control determines the speed of the glide. The portamento pedal turns this effect on and off.

**Pitch Bend:** This control bends notes up to one octave sharp or flat. The center "dead zone" facilitates tuning. In addition to extending the tuning range of the synthesizer up and down an extra octave, the Pitch Bend control permits you to bend individual notes, simulating the "pitch bend" techniques used by many guitarists.

The Voltage Controlled Oscillators produce pitched tones. The pitch of the oscillators is controlled by the slide tuning controls, the keyboard, the Pitch Bend knob, and other controllers.

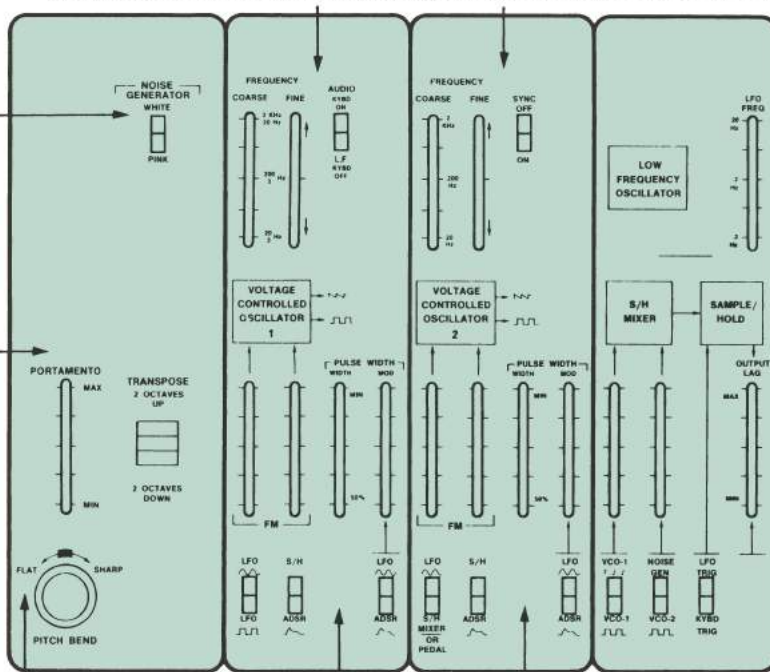

The Low Frequency Oscillator (LFO) is a controller; its output signal is used to create vibrato, tremolo, repeat and other effects.

The Sample and Hold circuit is a controller. It is used to create a random or regular series of tones or accents.

Pulse Width Modulation gives the pulse wave a "phase-shifting" quality.

## PANEL CONTROL DESCRIPTION CHART

The Voltage Controlled Filter is the heart of the synthesizer. It is used to create individual characteristics for each sound you make. The VCF can also function as an oscillator.

The Audio Mixer governs the volume of the oscillator and noise signals going into the filter.

The Ring Modulator intermodulates VCO 1 and VCO 2.

The VCF can be controlled by the KYBD or S/H. The footpedal overrides the S/H when it is plugged in.

The High-Pass is used to remove the low frequencies of a sound.

The Envelope Generator is used to program the attack and decay of sounds.

The Voltage Controlled Amplifier (VCA) governs the volume of the synthesizer's output.

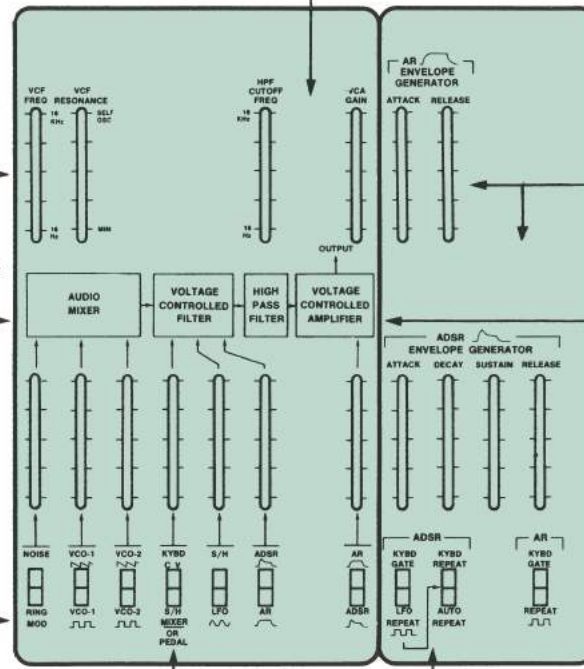

Repeat Switch: The Repeat Switch has three modes: KYBD GATE, Auto Repeat, and KYBD REPEAT.

# Hints on Using Your Odyssey.

1. You may tend at first to think of the control sliders on the Odyssey as something like stop tabs on an electronic organ. That is, you may be tempted to set them in a certain way and then “play” the Odyssey only from the keyboard. Try to overcome this temptation. Use the sliders in performance. Learn to change the sounds you are producing while you are producing them.
2. The patches given in this manual are very basic. Do not hesitate to search for improvements and variations on your own. In many cases a slight change in the position of a single control slider or attenuator can make a large difference in the sounds you are producing.
3. Resist the temptation to merely open as many sliders as possible, as far as possible.

# If you just have to start here:

## INSTANT ODYSSEY

Set up the sound shown on page 19 (opposite).

Play a two-part piece on the keyboard.

If you hear two voices with pedal control, turn the page and try more sounds.

If what you hear is nothing like two voices with pedal control, or if you don't hear anything, check the following things:

- 1). Is the "sync off/on" switch turned off? (top of Oscillator 2).  
If it's on, you'll hear only one voice even though you press down two keys.
- 2). Is the "audio kbd on/LF kbd off" switch turned on? (top of Oscillator 1).  
If it's off, your first tone source (VCO 1) will be way below what your ear can hear.
- 3). Is the "HPF cutoff" slider all the way down? (top of High Pass Filter).  
If it's up, you are cutting off your sound by eliminating all but the very highest overtones.
- 4). Is the "VCA gain" slider down? (top of Voltage Controlled Amplifier).  
If it's up, you'll hear sound all the time, even when you take your hand off the keyboard.
- 5). Are the "attack, decay, sustain, release" sliders raised partway? (under ADSR Envelope Generator).  
If they're all down, the attack & decay of your note will make only a tiny blip.
- 6). Is the Odyssey connected to the right amplification system? (back of instrument).  
The "low level" output on the back is for a standard musical instrument amp;  
the "high level" output is for a tape recorder, stereo amplifier, or electronic organ.
- 7). Is the Odyssey plugged in? Turned on?

NOTE: All sliders not illustrated should be all the way down.

Switches not illustrated do not affect the sound output in either position.

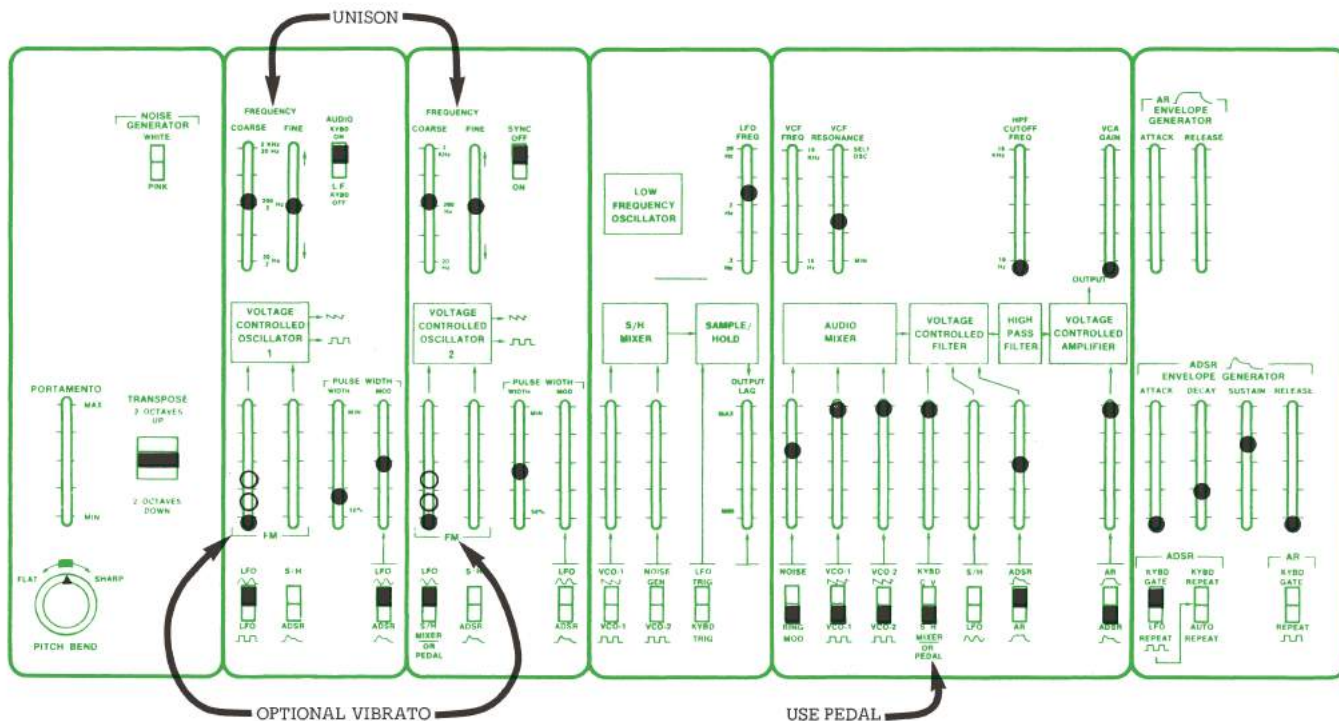

Tune VCO 1  
and VCO 2 to unison by  
holding down any key.

# 1. 2-Voice with Pedal Filter Control

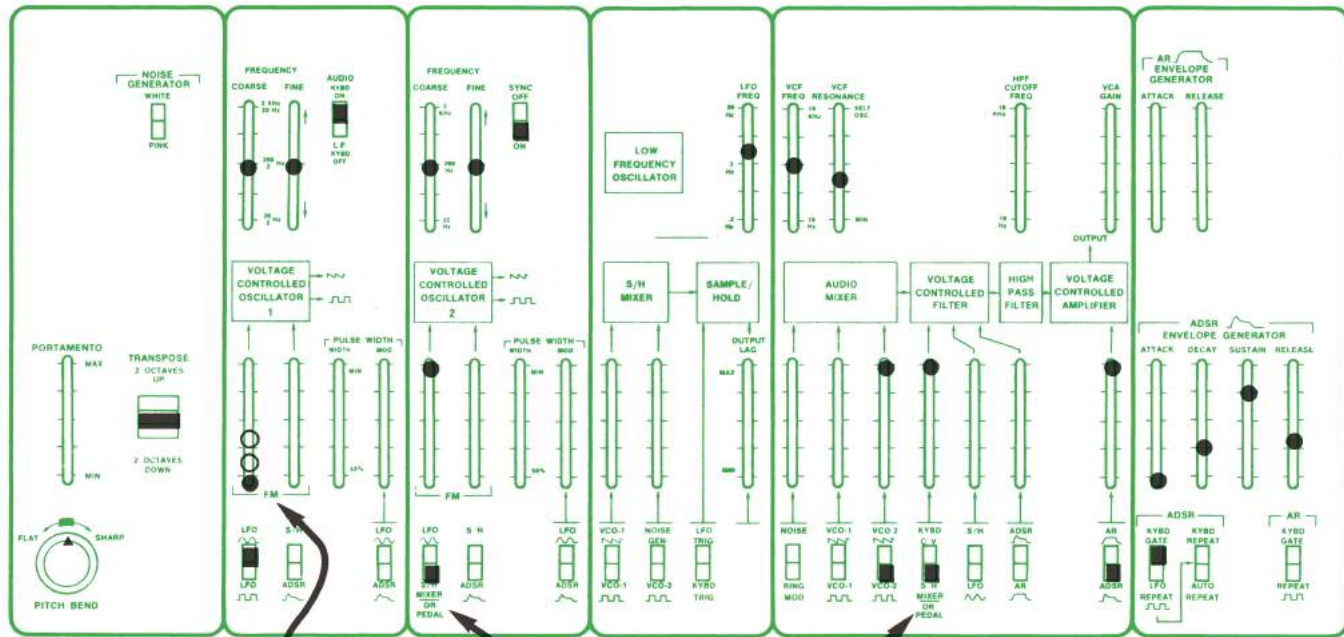

OPTIONAL VIBRATO

USE PEDAL

Single voice with pedal control.

## 2. Phase-Synchronized Oscillator

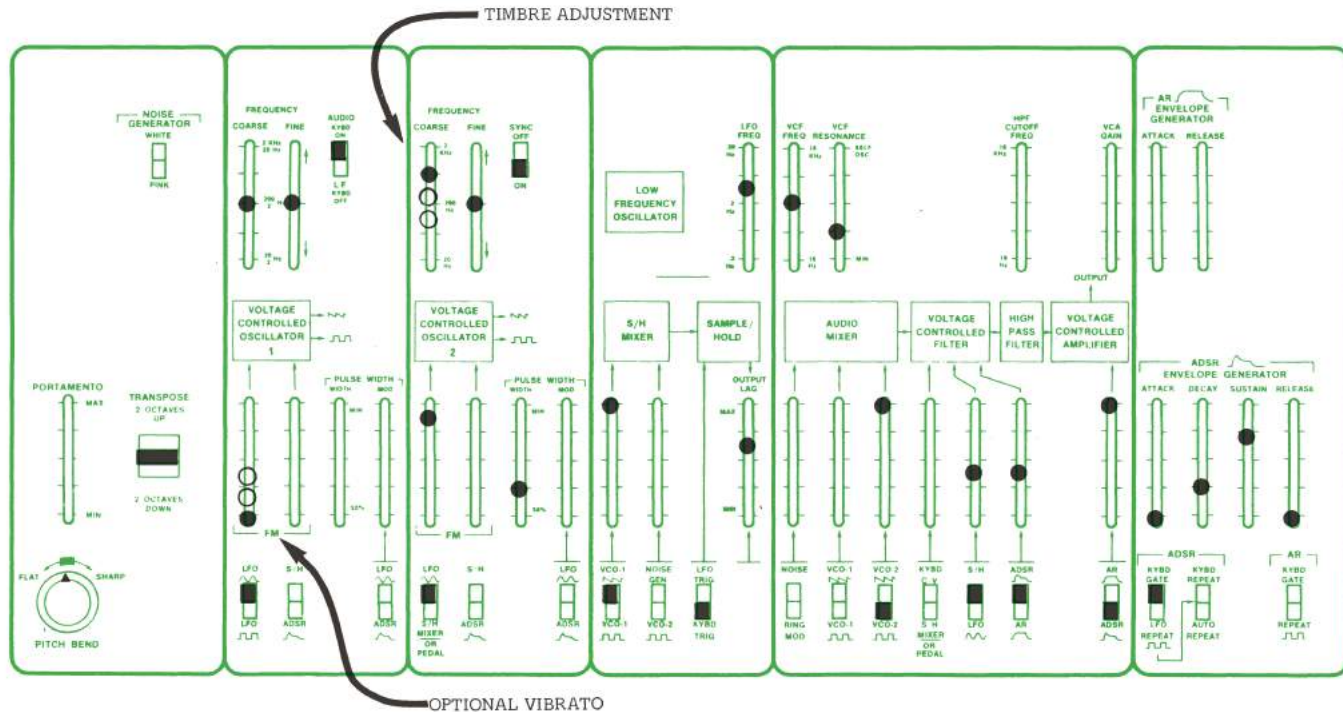

Timbre changes slightly with each note.

### 3. Guitar-Leslie

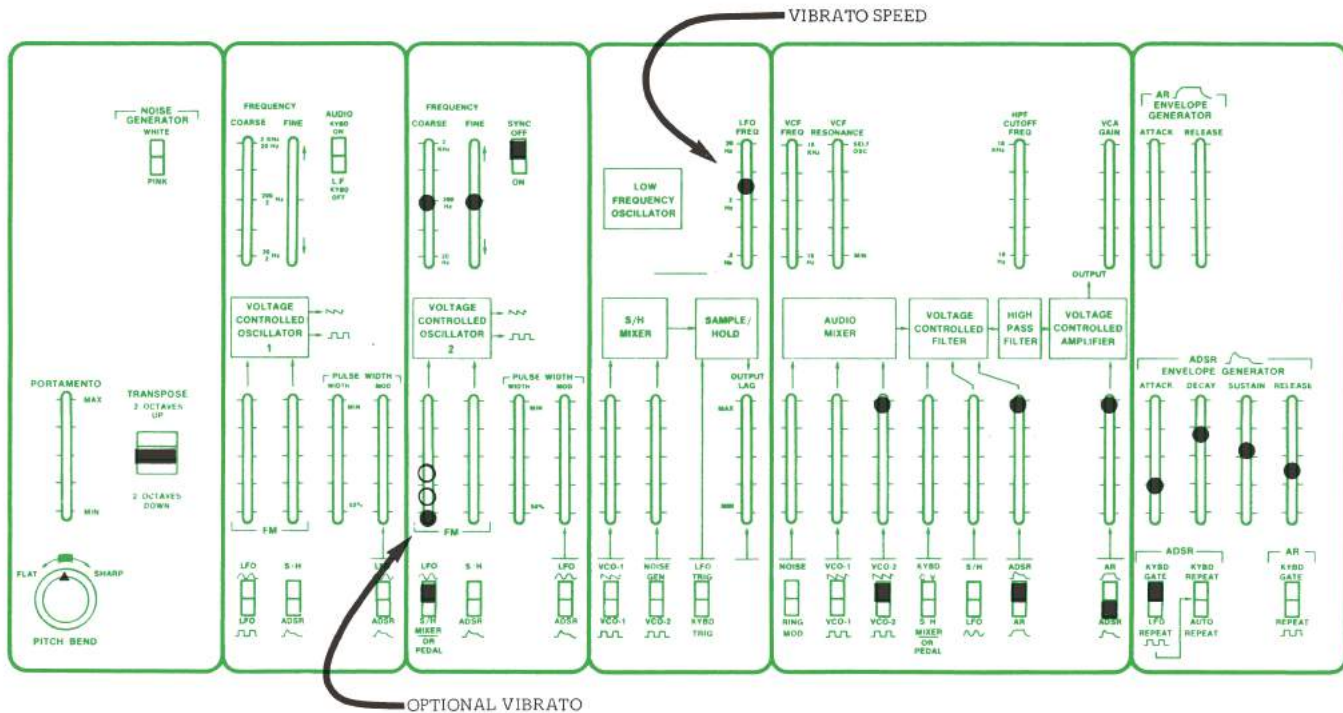

Single voice

# 4. Trumpet





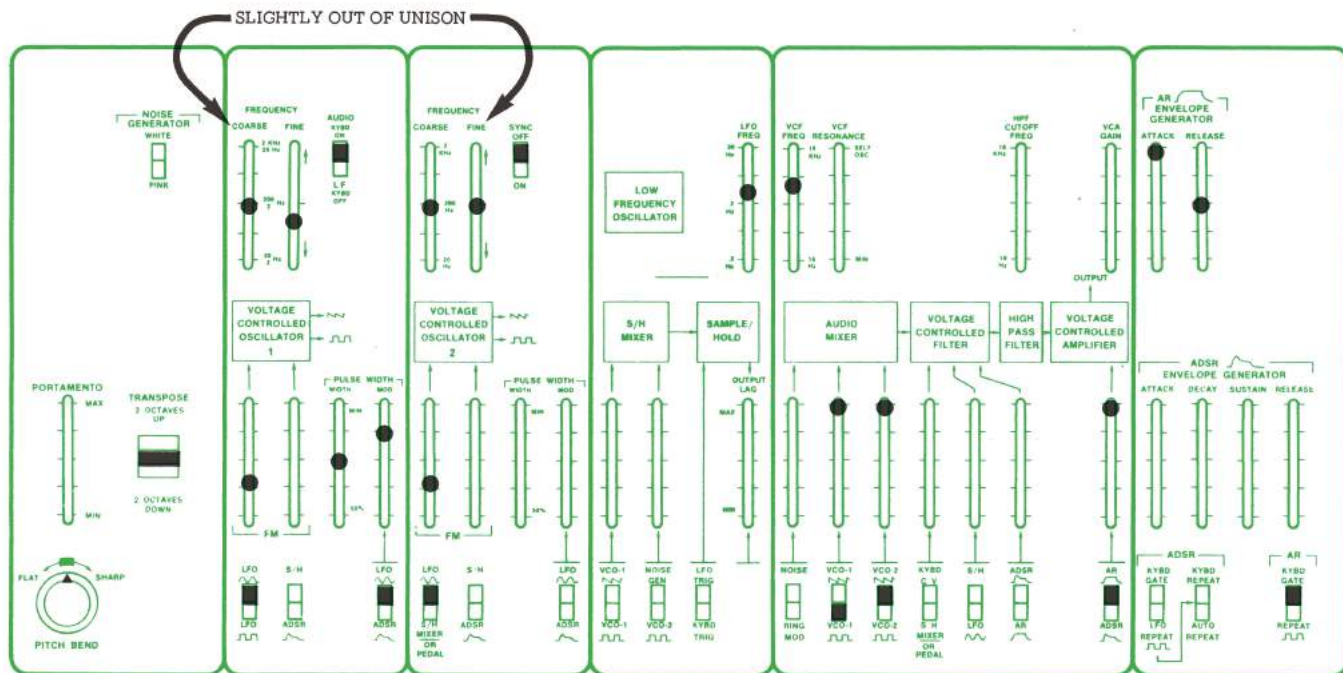

Use external reverb.  
 Play separate detached notes.

## 6. String Chorus

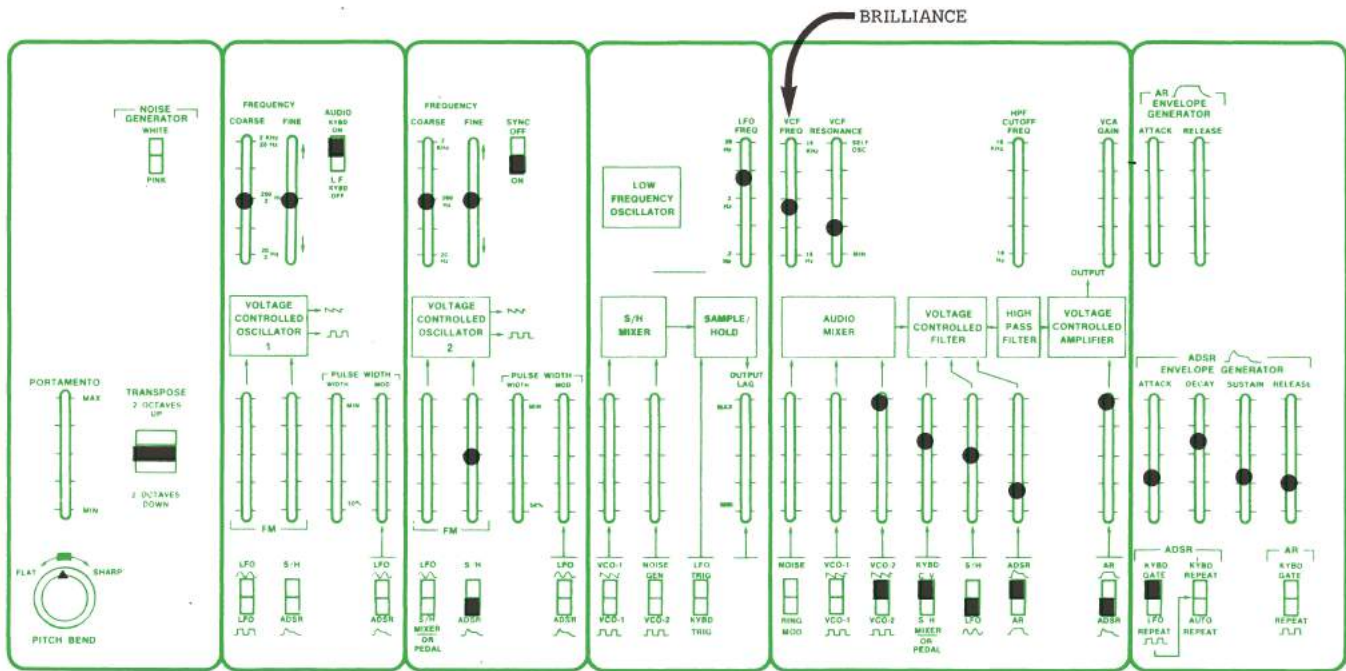

Single voice.

# 7. Flute

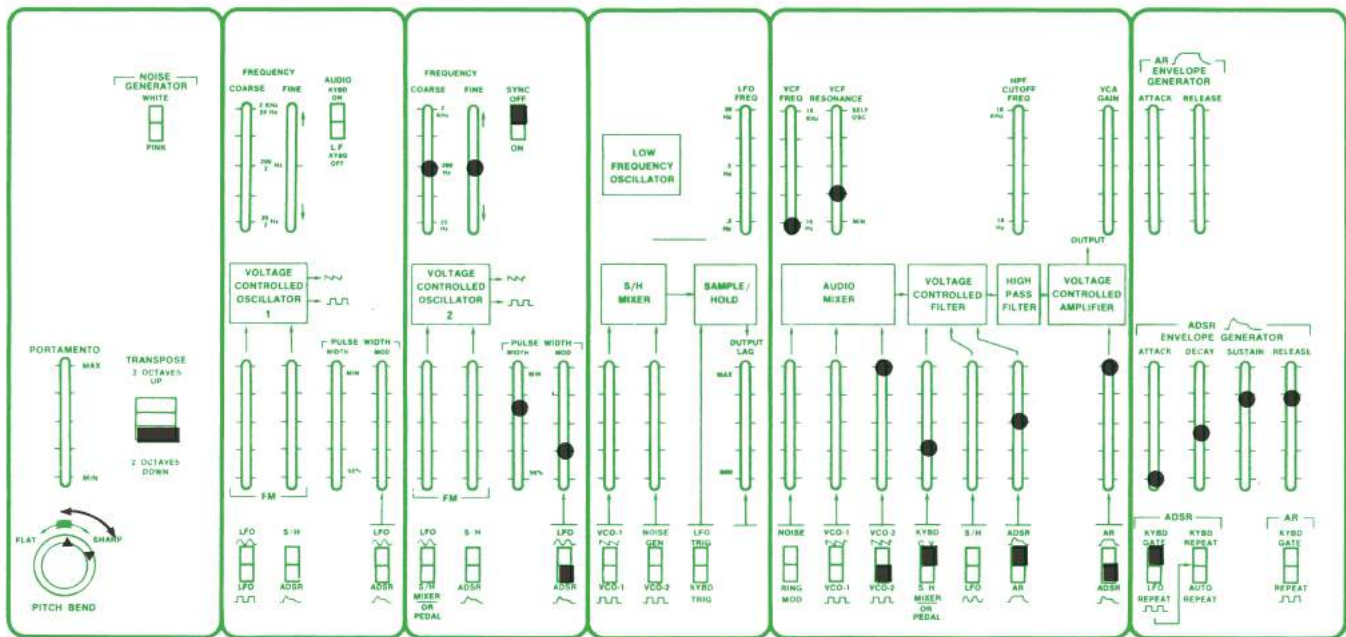

Use PITCH BEND to “bend” notes.

# 8. Electric Bass

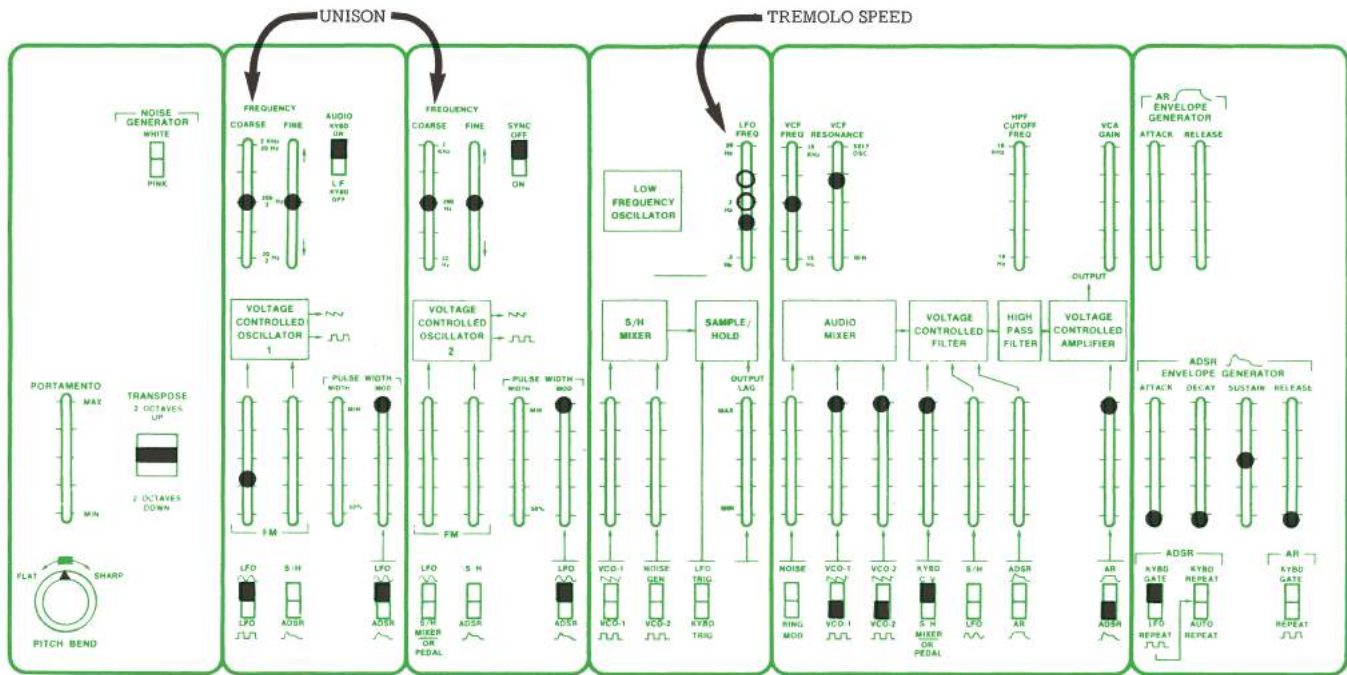

Set VCF RESONANCE at self-oscillating point;  
tune VCF FREQUENCY to a fifth above the VCOs.

# 9. Screamo Organo

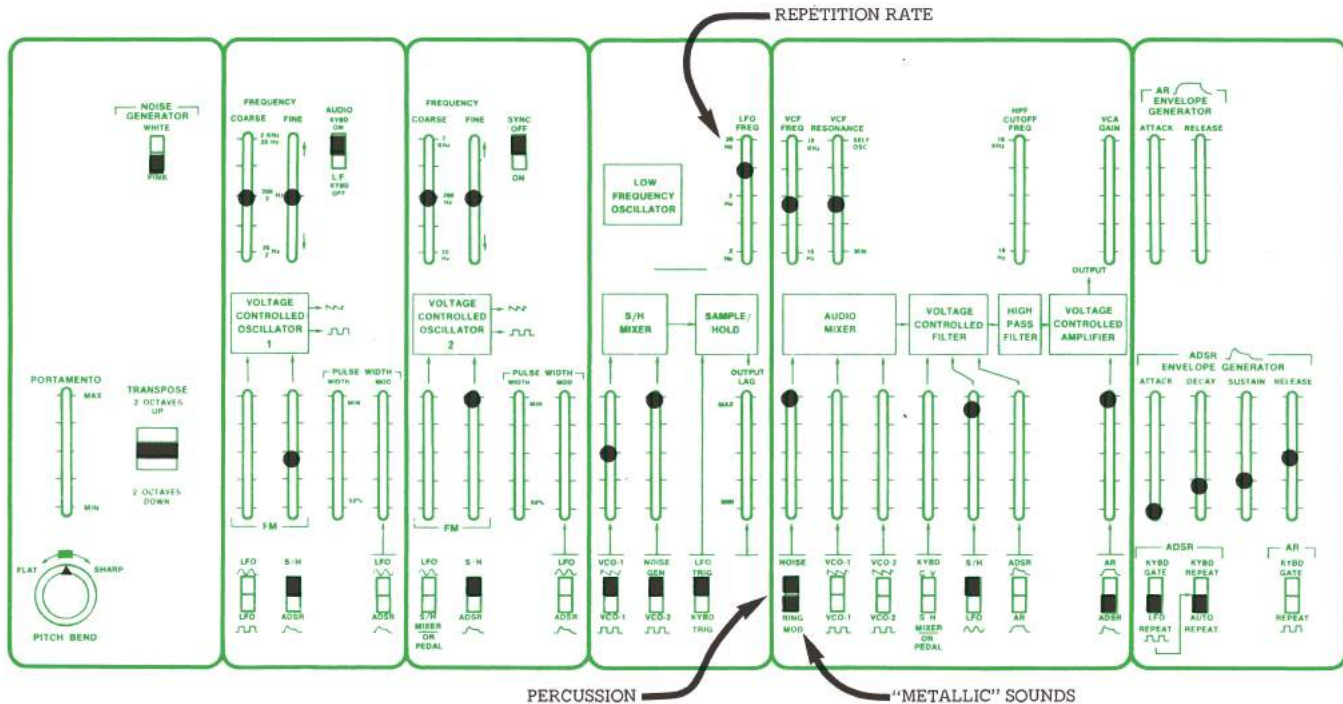

NOTE: Keyboard will "tune" metallic sounds and add off-beat accents.

# 10. Sample & Hold Percussion

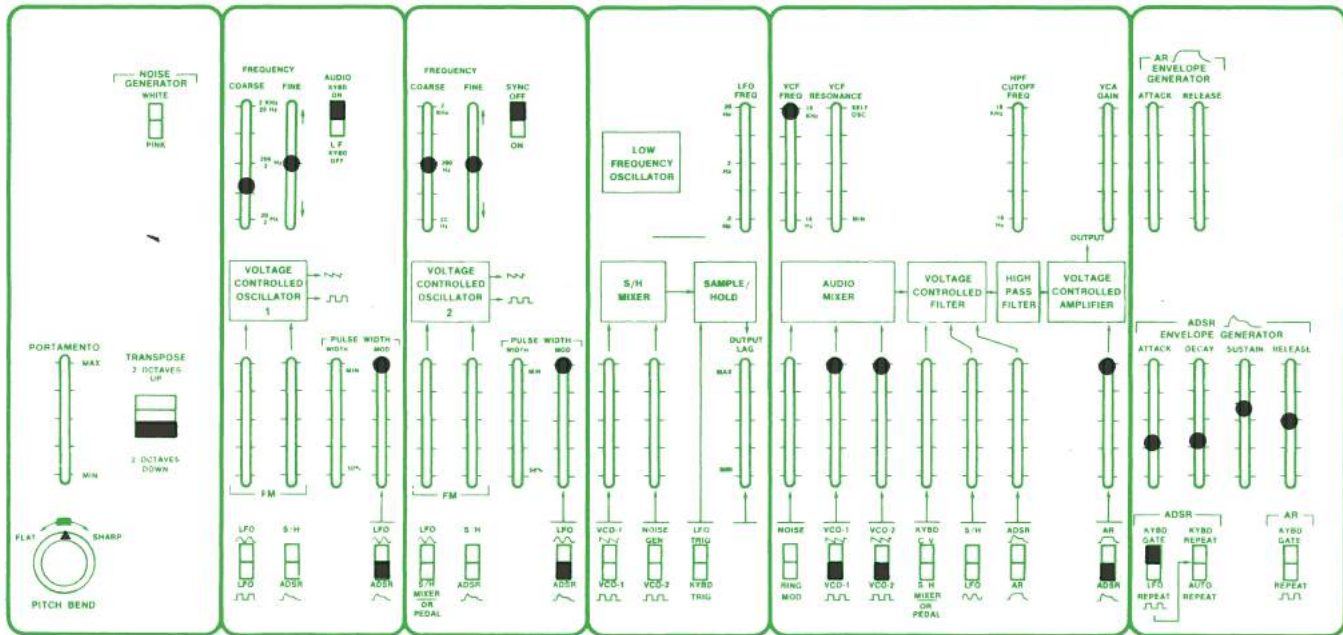

Tune VCO 1 one octave lower than VCO 2.

# 11. Heavy Led

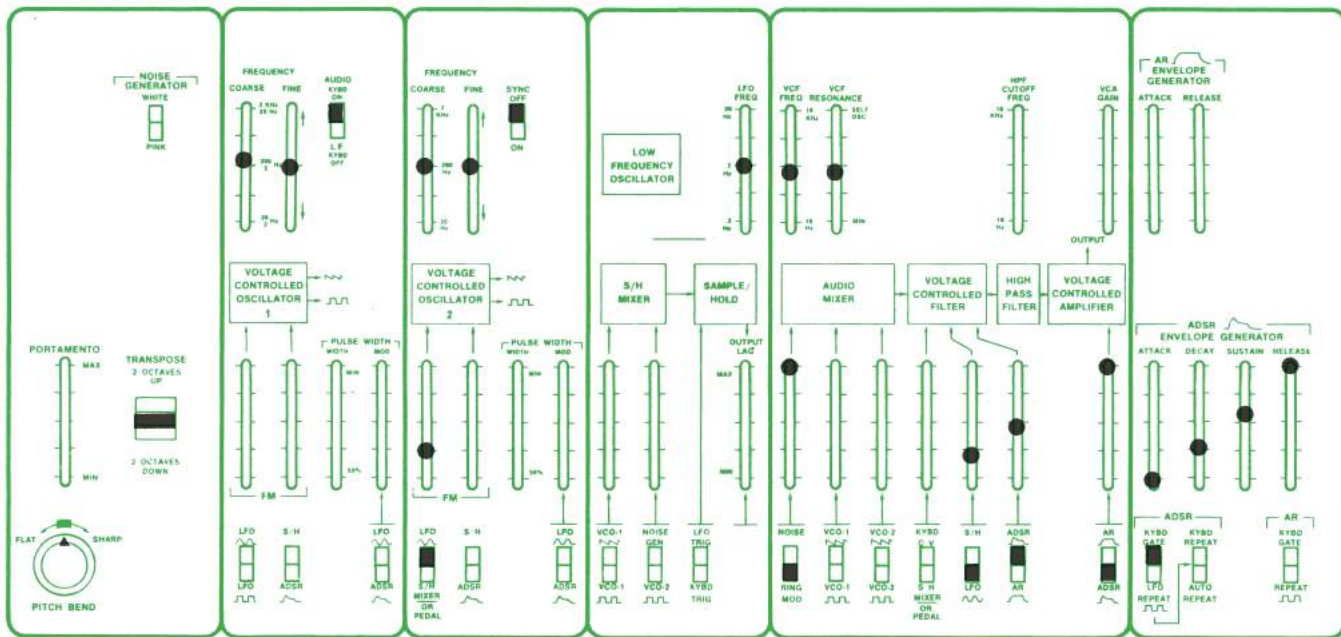

Tune VCOs 1 & 2 to different frequencies for different metallic timbres.

# 12. Gong/Chime



# Specifications

## NOISE GENERATOR

Noise spectrum types: White and Pink

## TRANSPOSE

Positions: Down 2 octaves, normal, up 2 octaves

## PITCH BEND

Frequency shift: About + 1 oct. (exactly +1 octave on Odyssey-II)

## PORTAMENTO

Maximum speed: About .01 msec./oct.

Minimum speed: About 1.5 seconds/oct.

## VOLTAGE CONTROLLED OSCILLATORS

Waveforms: Sawtooth, Square, Pulse, Dynamic Pulse

Frequency range: VCO 1 in low freq. mode, .2 Hz. to 20 Hz.; VCO 1 and VCO 2 (audio range) 20 Hz. to 20 KHz.

Warm up drift: 1/30 semitone from turn on max.

Pulse width: 50% to 5%

Pulse width modulation: ADSR, +45%; LFO, +15%

Voltage controlled response: 1 V/oct.

Maximum frequency shifts: LFO sine wave, +1/2 oct.; LFO square wave, +1.5 oct.; ADSR +9 oct.; S/H +2 oct.

Note: VCO 1 is low note priority; VCO 2 is high note priority

## VOLTAGE CONTROLLED FILTER

Type: Low pass

Frequency range: 16 Hz. to 16 KHz.

Maximum usable Q: 30

Resonance 1/2 to self oscillate

Voltage controlled response: 1V/oct.

## VOLTAGE CONTROLLED AMPLIFIER

Dynamic Range: 80dB.

#### RING MODULATOR

Type: Digital

Input signals: VCO 1 and VCO 2 square waves

#### SAMPLE AND HOLD

Command sources: Keyboard or LFO trigger

Sampled signals: VCO 1 square wave and sawtooth wave, VCO 2 square wave and pink noise

#### ADSR ENVELOPE GENERATOR

Attack time: 5 msec. to 5 seconds

Decay time: 10 msec. to 8 seconds

Sustain level: 0 to 100% of peak

Release time: 15 msec. to 10 sec.

#### AR ENVELOPE GENERATOR

Attack time: 5 msec. to 5 seconds

Release time: 10 msec. to 8 seconds

#### AUDIO OUTPUTS

High level: 2.5 V PP max.; 100K impedance

Low level: .25 V PP max.; 10K impedance

#### INTERFACE JACKS

Keyboard CV IN/OUT: 1 V/oct.

Gate OUT: +10 V, key down; 0 V all keys up

Gate IN: +8 V minimum

Trigger OUT: +10 V pulse on key depression,  
10 microsec. duration

Trigger IN: +8 V pulse min., 10 microsec duration  
minimum

External Audio Input: 500 millivolts for full  
output



