

BOSS
BX-8/16
8/16 CHANNEL
STEREO MIXER

Owner's Manual

Please read the owner's manual carefully.

FEATURES

- The BX-8 and BX-16 are compact, light, yet versatile mixers featuring stereo outputs.
- By adjusting the Gain Control Knobs, it is possible to feed all sorts of sound sources such as microphone or line input to the mixer.
- The Overload and the Level Indicators help you achieve proper mixing with little noise and distortion.
- Provided with two types of Effect Send/Return Jacks, the mixer can be simultaneously used with two effect units, such as a reverb and delay.
- The mixer features both standard phone and pin jacks for output, and therefore can be connected to a tape deck.
- Provided with the Output Level Selector Switch, the mixer is compatible with audio and PA equipment.
- The Headphone Jack is provided for monitoring through headphones.

CONTENTS

■ Panel Description	3
■ Connection	8
■ Operation	9
■ Block Diagram	12
■ Important Notes	13
■ Specifications	14

■ PANEL DESCRIPTION

«BX-8»

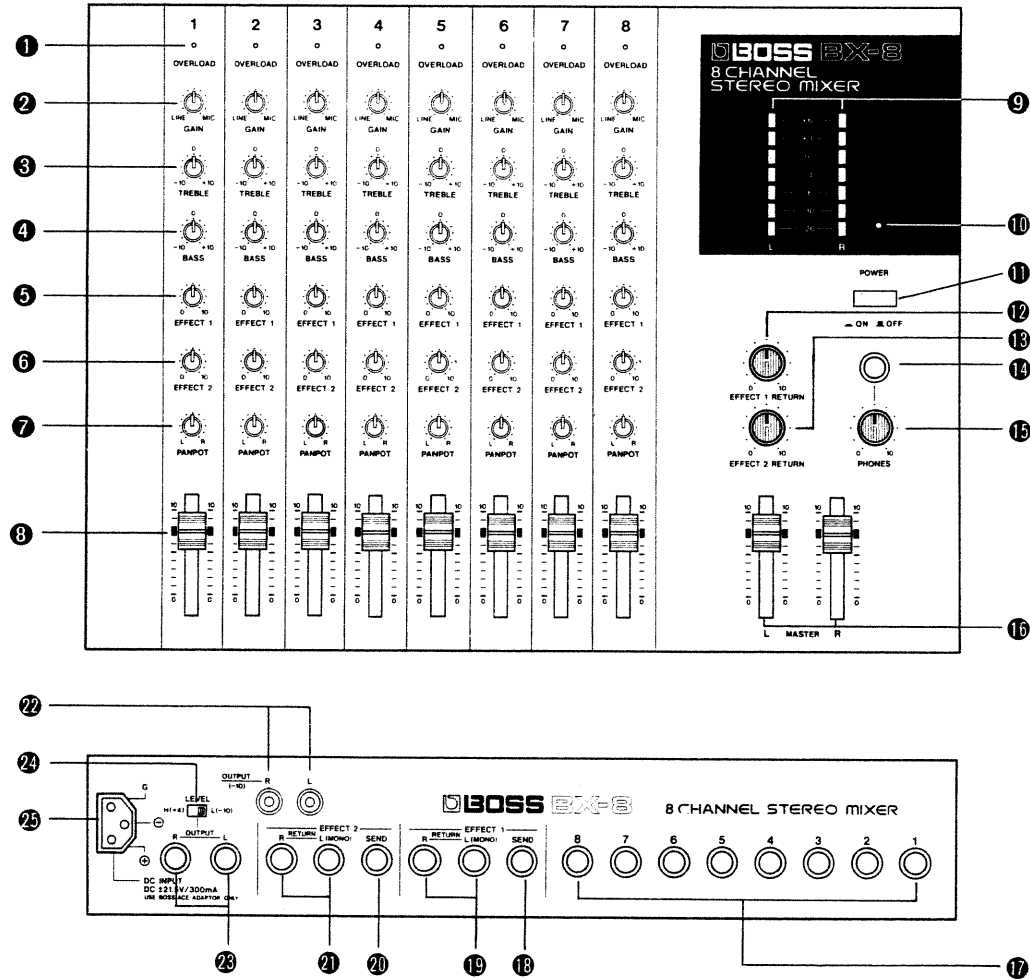

«BX-16»

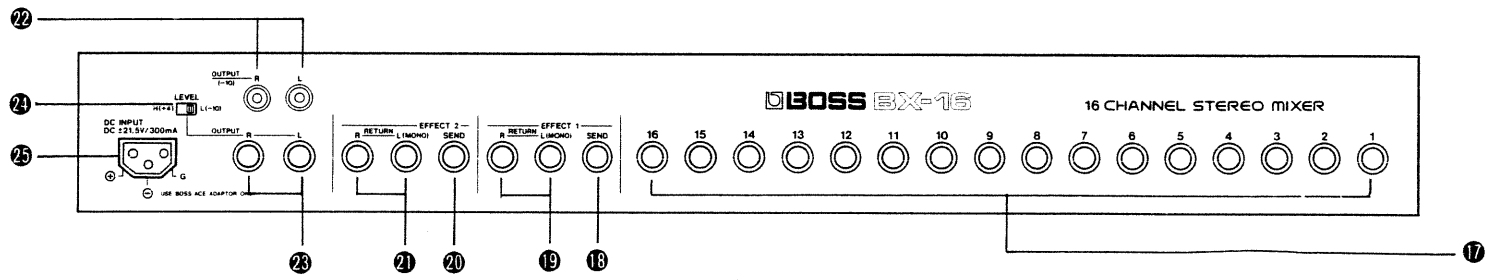
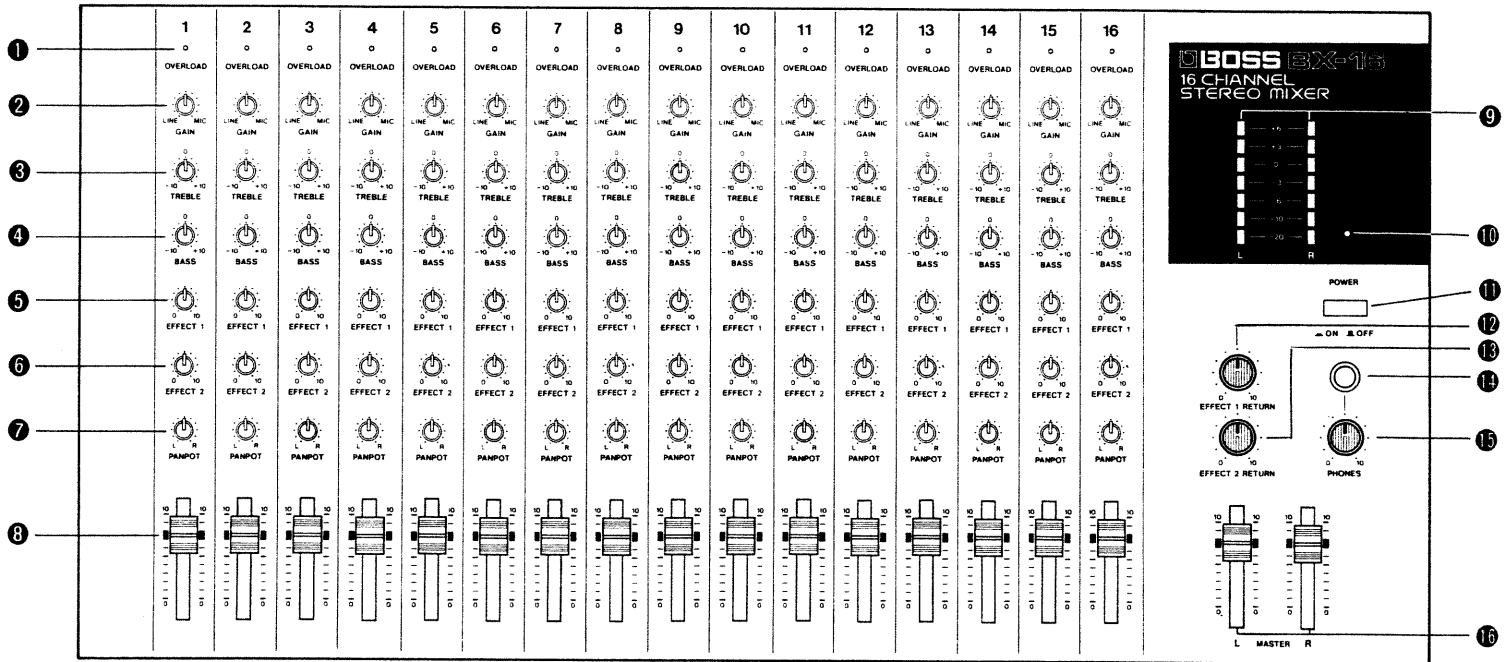

❶ Overload Indicators

This lights up when the input signal level of each channel is too high. If this lights, rotate the relevant Gain Knob counterclockwise to decrease the input sensitivity.

* The Overload Indicators light up when the level of the signal is 6dB lower than the clipping level (=the level where the sound starts being distorted).

❷ Gain Knobs

The Gain Knobs of each channel adjusts the input gain for mixing the signal with the lowest possible noise and distortion. Clockwise rotation raises the gain (=increasing the volume).

❸ Treble Knobs

This controls treble sounds. Rotating this clockwise will boost higher frequencies and counterclockwise cut them.

❹ Bass Knob

This knob controls bass sounds. Rotating this clockwise will boost lower frequencies and counterclockwise cut them.

❺ Effect 1 Send Knobs

These knobs control the level of the signals to be sent to the Effect 1 Send Jack. Clockwise rotation increases the level. For instance, when a reverb unit is connected

to the Effect 1 Send/Return Jacks, rotating this knob clockwise will deepen the reverb effect.

* The output from the Effect 1 Send is post fader, and therefore changes depending on the positions of the Gain, Treble, Bass and Channel Fader Knobs.

❻ Effect 2 Send Knobs

These knobs control the level of the signals to be sent to the Effect 2 Send Jack. Clockwise rotation increases the level. For instance, when a reverb unit is connected to the Effect 2 Send/Return Jacks, rotating this knob clockwise will deepen the reverb effect.

* The output from the Effect 2 Send is post fader, and therefore changes depending on the positions of the Gain, Treble, Bass and Channel Fader Knobs.

❼ Panpot Knobs

Each Panpot Knob routes the input signal from an Input Channel to the left and/or right mixing busses. By means of the Panpot Knobs, input signals can be sent exclusively to one mixing bus, or the other, to both mixing busses equally or since the Panpot Knob is continuously variable to both mixing busses in any relative proportion desired.

❽ Channel Faders

This adjusts the level of the signal sent from each channel. Raising the slider will increase the level, and lowering it will decrease. 7 to 8 position may be ideal for the lowest noise and distortion.

9 Level Meters

These indicate the level of the output signals. When "0" of the Level Meter is lit, the output level is -10dBm from the pin jack, and from the standard phone jack is +4dBm with the Output Level Selector set to "+4", and -10dBm when it is set to "-10".

10 Pilot Lamp

When the mixer is turned on, this lamp lights up.

11 Power Switch

This turns on or off the mixer. When it is turned on, the Pilot Lamp lights up.

* Turn on or off the mixer with the Master Faders set to zero

12 Effect 1 Return Knob

This knob controls the mixing level of the signal returned to the Effect 1 Return Jacks (L,R) from the external effect (delay, reverb, etc). Clockwise rotation increases the level. Effect 1 Send/Return Jacks, this knob controls the overall volume of the reverb sounds while the Effect 1 Send Knob controls the reverb level of each channel.

13 Effect 2 Return Knob

This knob controls the mixing level of the signal returned to the Effect 2 Return Jacks (L,R) from the external effect (delay, reverb, etc). Clockwise rotation increases the level.

14 Headphone Jack

Connect stereo headphone to this jack.

15 Headphone Level Knob

This knob controls the volume of the headphone sounds. Rotating this clockwise increases the volume.

* The Headphone Level circuits are completely independent from the Master Fader, therefore you can monitor sounds through headphones even the Master Fader is set to zero.

16 Master Faders (L, R)

These sliders control the overall volume of the mixed signals separately for left and right. Raising the slider will increase the volume and lowering it decrease. The optimum level with the lowest noise and distortion is where the red indicators of the Level Meters light occasionally.

17 Input Jacks

These are input jacks for connecting to a mixing device such as microphone, electronic musical instrument, tape deck or CD.

18 Effect 1 Send Jack

This is an output jack for connecting the input jack of an external effect unit (delay, reverb, etc). Through this jack, the signal which has been level-adjusted at the Effect 1 Send Knob of each channel is sent out.

19 Effect 1 Return Jack (L, R)

These are input jacks for connecting to the output jacks of an external effect (delay, reverb, etc). Signal fed into each of L and R jacks is separately level-adjusted with the Effect 1 Return Knob, then mixed with the output signal in stereo.

* When the external effect unit has only a monaural output, connect it to the L jack on the mixer.

20 Effect 2 Send Jack

This is an output jack for connecting the input jack of an external effect unit (delay, reverb, etc). Through this jack, the signal which has been level-adjusted at the Effect 2 Send Knob of each channel is sent out.

21 Effect 2 Return Jack (L, R)

These are input jacks for connecting to the output jacks of an external effect (reverb or delay etc). Signal fed into each of L and R jacks is separately level-adjusted with the Effect 2 Return Knob, then mixed with the output signal in stereo.

* When the external effect unit has only a monaural output, connect it to the L jack on the mixer.

22 Output Pin Jacks (L, R)

Through these pin jacks, mixed signal is sent out. Connect these to a tape deck, etc.

23 Output Jacks (L, R)

Through these jacks, mixed signal is sent out. Connect these to a power amplifier, etc.

24 Output Level Selector Switch

This switch selects output level of the signal sent from the Output Jacks. At the "+4" position, the rated output level (the output level when the Level Meter 0 is lit) is +4dBm, and at "-10", it is -10dBm.

25 AC Adaptor Connector

Connect the supplied AC adaptor to this connector.

■ CONNECTION

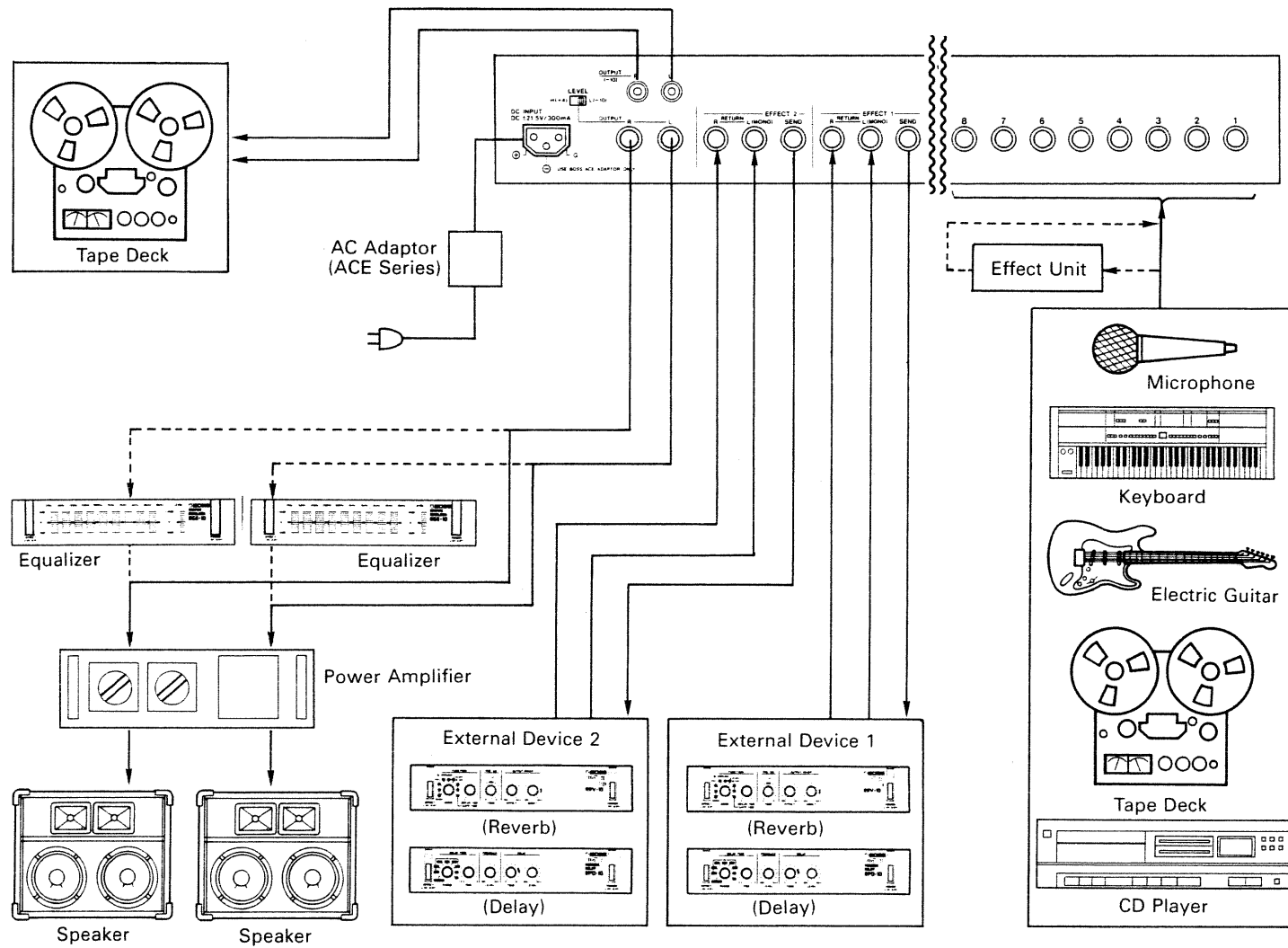

■ OPERATION

- ① Make all the necessary connections, then set each Gain Knob to "LINE" position, and set each Channel Fader, Master Fader, Effect 1 Return Knob and Effect 2 Return Knob to the "0" position.

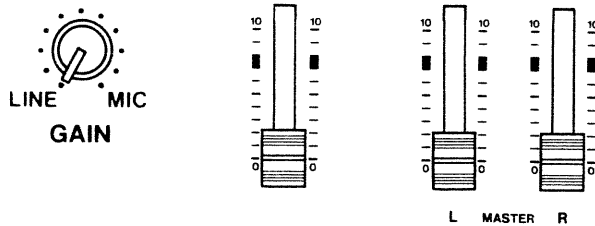

- ② Set the Output Level Selector Switch to the "+4" or "-10" position depending on the type of the device connected to the Output Jacks.

[e.g.] +4dBm : PA Equipment
 -10dBm : Audio Equipment



- ③ Make sure that the mixer is turned off, and connect the supplied AC adaptor to the AC Adaptor Connector, then the power plug to the socket.

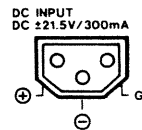

- ④ Turn the mixer on and make sure that the Pilot Lamp lights up.

*For about a few seconds after the units is turned on, it does not function because of the muting circuit.

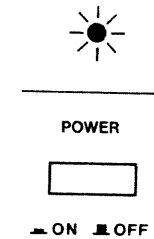

- ⑤ Turn on the units connected to the Output Jacks and the Output Pin Jacks, such as a power amplifier, tape, deck, etc.

- ⑥ Set the Channel Fader and Master Faders to "7" positions.

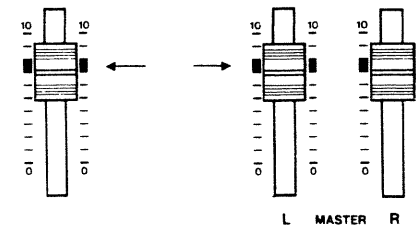

- ⑦ Adjust the level balance of each channel with the Gain Knob.

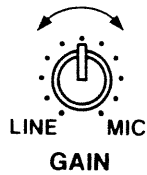

- * Adjust each channel so that the Overload Indicator will not light.



- * To prevent inconsistency of each channel balance caused by moving the Channel Fader, use only the Gain Knob for adjusting the balance of each channel and use the Channel Fader only for Fade In or Fade Out.

- ⑧ Set the sound imaging positioning with the Panpot Knob of each channel.



- * When feeding from stereo source (e.g. CD or tape), use two channels, with the Panpot of the left (L) output rotated fully counterclockwise and the Panpot of the right (R) output fully clockwise.

- ⑨ Make a desired tone using the Treble and Bass Knobs.

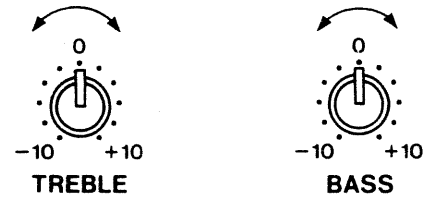

- ⑩ Adjust the Master Faders depending on the level of the external device.

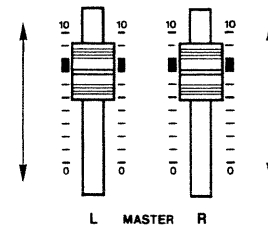

[Effect Settings]

- ① Set the external effect units to your taste.
 - ② Set the mixing level of the effect sound using the Effect Return Knob.
- * Usually, set this to the "5" position. (To increase the level of the effect sound, set to a higher number position.)

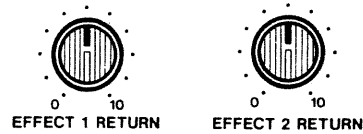

- ③ Adjust the balance of effect sound using the Effect Send Knob of each channel.

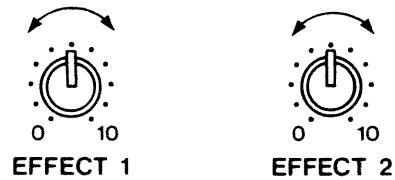

[Headphone Level Settings]

- ① Adjust the volume of the headphones using the Headphone Level Knob.

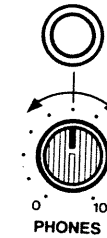

- * Changing the Headphone Level Knob does not affect the output level.

■ BLOCK DIAGRAM

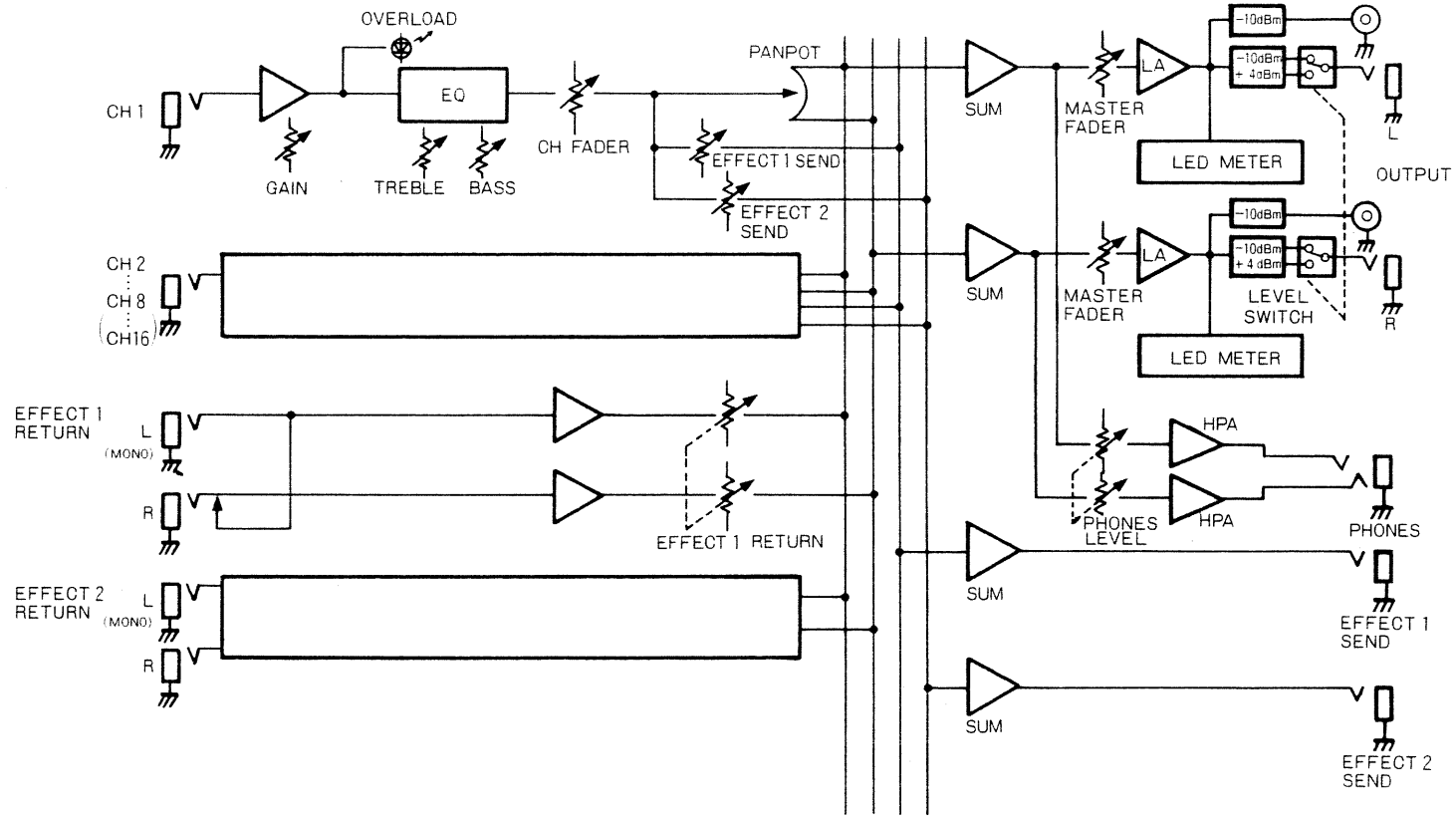

■ IMPORTANT NOTES

- Use the supplied AC Adaptor; ACE-120, 220 or 240. Using any other adaptor will cause trouble.
- When the unit is not to be used for a long period of time, disconnect the AC adaptor from the socket.
- Avoid using this device in extreme heat, humidity or where it may be affected by dust or vibration.
- Use a mild detergent and soft cloth for cleaning. Do not use solvents such as thinner.
- If this unit does not operate properly, unplug the power cable immediately and contact your local Roland service center.
- Switch on to mixer first, then the power amplifier. Switch off the power amplifier first, then the mixer. In both cases, set all the Faders to zero.
- For about a few seconds after the units is turned on, it does not function because of the muting circuit.

■ SPECIFICATIONS

Common for the BX-8 and BX-16

Input Level

Rated: -50dBm to -10dBm

Input Impedance

$1.8\text{k}\Omega$ to $100\text{k}\Omega$

Output Level (Standard Phone Jack)

Rated: $+4\text{dBm}$ / -10dBm

Maximum: $+21\text{dBm}$

Output Level (Pin Jack)

Rated: -10dBm

Maximum: $+7\text{dBm}$

Output Load Impedance

More than $10\text{k}\Omega$

Effect Send

Output Level (Rated): -20dBm

Output Load Impedance: more than $10\text{k}\Omega$

Effect Return

Input Level (Rated): -20dBm

Input Impedance: $47\text{k}\Omega$

Equalizer

Treble: $\pm 10\text{dBm}/10\text{kHz}$

Bass: $\pm 10\text{dBm}/100\text{Hz}$

Headphones

$50\text{mW}/30\Omega$

Equivalent Input Noise

-115 dBm (IHF-A)

Frequency Response (at the minimum gain)

20Hz to 40kHz ($\pm 3\text{dB}$)

@ $0\text{dBm} = 0.775\text{V}$

Accessory

AC Adaptor (BOSS ACE-120, 220 or 240)

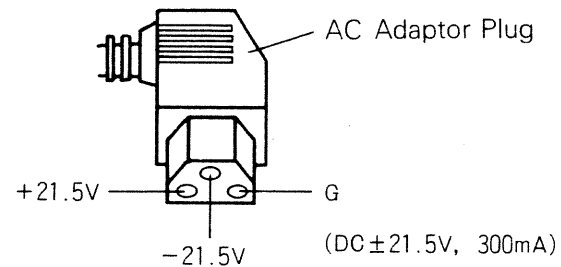

«For the BX-8»

Controls

Gain × 8
Treble × 8
Bass × 8
Effect 1 Send × 8
Effect 2 Send × 8
Panpot × 8
Channel Fader × 8

Main Controls

Master Fader × 2
Effect 1 Return × 1
Effect 2 Return × 1
Headphone Level × 1
Output Level Selector Switch × 1
Power Switch × 1

Jacks

Input × 8
Effect Send × 2
Effect Return × 4 (L/MONO×2, R×2)
Output (Standard Phone Jack) × 2
Output (Pin Jack) × 2
Headphone × 1

Indicators

Overload × 8
Pilot Lamp × 1
Level Meter × 2

Consumption

10W

Dimensions

310(W) × 69(H) × 237(D) mm/
12-3/16" × 2-11/16" × 9-5/16"

Weight

1.6kg/13lb 8oz

«For the BX-16»

Controls

Gain × 16
Treble × 16
Bass × 16
Effect 1 Send × 16
Effect 2 Send × 16
Panpot × 16
Channel Fader × 16

Main Controls

Master Fader × 2
Effect 1 Return × 1
Effect 2 Return × 1
Headphone Level × 1
Output Level Selector Switch × 1
Power Switch × 1

Jacks

Input × 16
Effect Send × 2
Effect Return × 4 (L/MONO×2, R×2)
Output (Standard Phone Jack) × 2
Output (Pin Jack) × 2
Headphone × 1

Indicators

Overload × 16
Pilot Lamp × 1
Level Meter × 2

Consumption

12W

Dimensions

480(W) × 69(H) × 237(D) mm/
18-7/8" × 2-11/16" × 9-5/16"

Weight

2.5kg/5lb 8oz

*Specifications are subject to change
without notice.

Information

- Please use this AC adaptor only with the specified device.
- Please use the AC Adaptor of an appropriate voltage (120, 220 or 240) depending on the voltage system in your country.
- When the device is not to be used for a long period, be sure to disconnect the AC adaptor (Power Supply Unit) from the wall outlet.
- When you need repair service, call your local Roland Service Station as shown below or the authorized Roland distributor in your country.

U.S.A.

Roland Corp US
7200 Dominion Circle
Los Angeles, CA.90040-3647
U.S.A.
☎ (213) 685-5141

CANADA

Roland Canada Music Ltd.
(Head Office)
13880 Mayfield Place,
Richmond
British Columbia
Canada V6V 2E4
☎ (604) 270-6626

Roland Canada Music Ltd.
3469-rue Ashby
St-Laurent,
Quebec H4R 2C1
☎ (514) 335-2009

Roland Canada Music Ltd.
Unit B12-1515 Matheson Blvd
Mississauga, Ontario L4W 2P5
☎ (416) 625-4880

AUSTRALIA

Roland Corporation
(Australia) Pty. Ltd.
(Head Office)
38 Campbell Avenue
Dee Why West, NSW 2099
Australia
☎ (02) 982-8286

Roland Corporation
(Australia) Pty. Ltd.
(Melbourne Office)
50 Garden Street
South Yarra, Victoria 3141
Australia
☎ (03) 241-1254

NEW ZEALAND

Roland Corporation
(NZ) Ltd.
9 Nugent Street, Grafton
Auckland 3
New Zealand
☎ (09) 398-715

UNITED KINGDOM

Roland (UK) Ltd.
Great West Trading Estate
983 Great West Road
Brentford, TW8 9DN,
Middlesex, England
☎ (01) 568 4578

WEST GERMANY

Roland Elektronische
Musikinstrumente
Handelsgesellschaft mbH.
Oststrasse 96,
2000 Norderstedt
West Germany
☎ 040/526 0090

BELGIUM/HOLLAND LUXEMBOURG

Roland Benelux N.V.
Houtstraat 1
B-2431 Oevel-Westerlo
Belgium
☎ 014-58 45 35

DENMARK

Roland Scandinavia A/S
Norre Sogade 49, 1370
Copenhagen K.
Denmark
☎ (01) 11 31 11

SWEDEN

Roland Scandinavia A/S
Storskarsgatan 4
115 29 Stockholm
Sweden
☎ 08-65 32 40/65 32 50

NORWAY

Benum Music A/S
Haakon den godes Vei 14
N-0319 Oslo 3, Norway
(Box 145 Vinderen, N-0319
Oslo 3 Norway)
☎ 02 141266

FINLAND

OY Musiikki Fazer Musik AB
Takomotie 3
00380 Helsinki 38, Finland
☎ 05 56551

ITALY

Roland Italy S.p.A.
Via Gallarate 58
20151 Milano
Italy
☎ 02-3086849

SWITZERLAND

Musitronic AG
Gerberstrasse 5, CH-4410
Liestal
Switzerland
☎ 061/91 16 15

FRANCE

Musikengro
102, Avenue Jean-Jaures
69007 Lyon Cedex 07
☎ (7) 858-54 60

Musikengro
(Paris Office)
Centre Region Parisienne
41 rue Charles-Fourier, 94400
Vitry s/Seine
☎ (1) 680 86 62

SPAIN

Vietronic S.A.
Bolivia 239
08020 Barcelona
☎ 93-307 47 12

AUSTRIA

E. Dematte & Co.
Nue-Rum Siemens-Strasse 4
A-6021 Innsbruck box 591
☎ (05222) 63 451

GREECE

A. ANDREADES & Co. L.T.D.
2 Phidiou street,
GR 10026B Athens
☎ 3620130

Products of Roland

Printed in Japan Jun. '88 E-3

BX-8/10



UPC 2603061700

1988

2603061700